

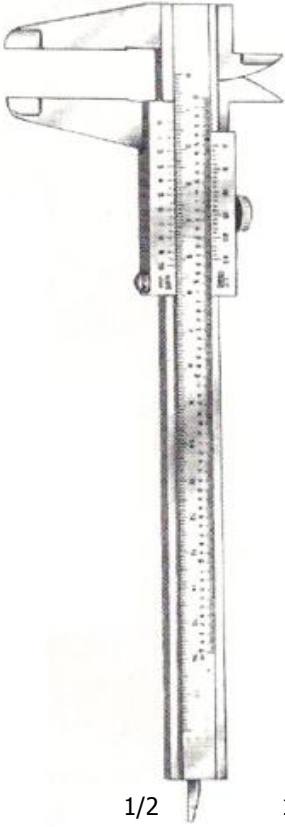

1. BÖLÜM

GENEL ALETLER General Surgery



1/2

Ölçme 150 mm
Measuring 150 mm
ÜK.001

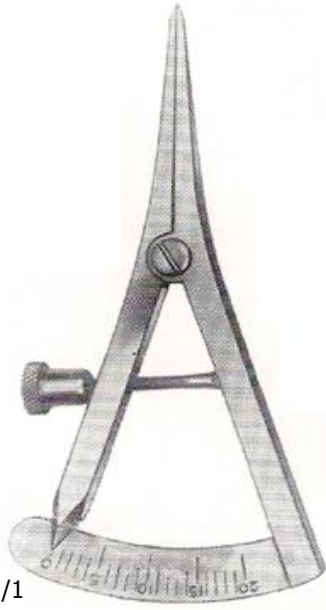

1/1

CASTROVIEJO
Ölçme 20 mm
Measuring 20 mm
ÜK.002

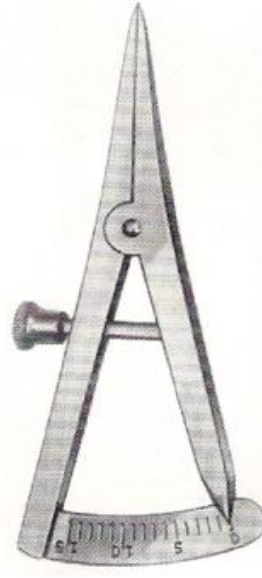

1/1

CASTROVIEJO
Ölçme 15 mm
Measuring 15 mm
ÜK.003

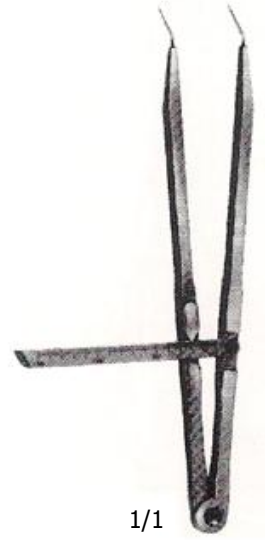

1/1

Ölçme 150 mm
Measuring 150 mm
ÜK.004

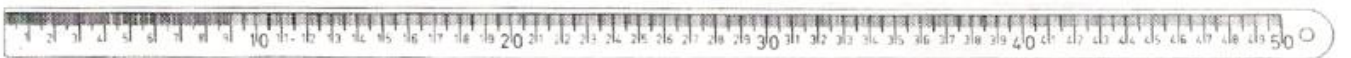

10 cm **ÜK.005**
15 cm **ÜK.006**
20 cm **ÜK.007**
30 cm **ÜK.008**
50 cm **ÜK.009**



1/1

20 cm
ÜK.010



33 cm
ÜK.011



1/1

CASPAR – 18 cm
ÜK.012



1/1

3 No - 16.5 cm
ÜK.013



1/1

3 No - 16 cm
ÜK.014



1/1

15.5 cm
ÜK.015



1/1

13.5 cm
ÜK.016



LANDOLT
25 cm
ÜK.017



3 No
21 cm
ÜK.018

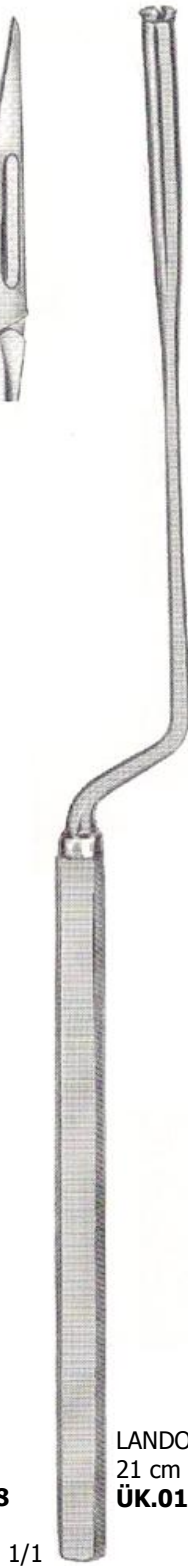

LANDOLT
21 cm
ÜK.019



TROUTMAN-CHRIS
Ø 5.5 mm - 9 cm
ÜK.020



CASTROVIEJO
Ø 8 mm - 13 cm
ÜK.021



3 No



1/1

22.5 cm
ÜK.022



1/1

22.5 cm
ÜK.023

1/1



1/1

21.5 cm
ÜK.024



1/1

13.5 cm
ÜK.025



1/1

13.5 cm
ÜK.026

4 No



1/1

22.5 cm
ÜK.027



1/1

1/1

22.5 cm
ÜK.028



1/1

21.5 cm
ÜK.029



1/1

15 cm
ÜK.030



1/1

13.5 cm
ÜK.031



1/1

13.5 cm
ÜK.032

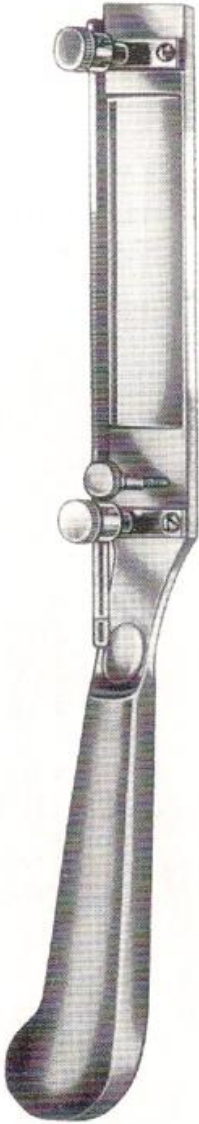

1/2
SCHINIC – 30 cm
ÜK.033



1/2
WATSON – 30 cm
ÜK.034



1/2
REHN – 23.5 cm
ÜK.035



1/2
SILVER – 19 cm
ÜK.036



ÜK.037

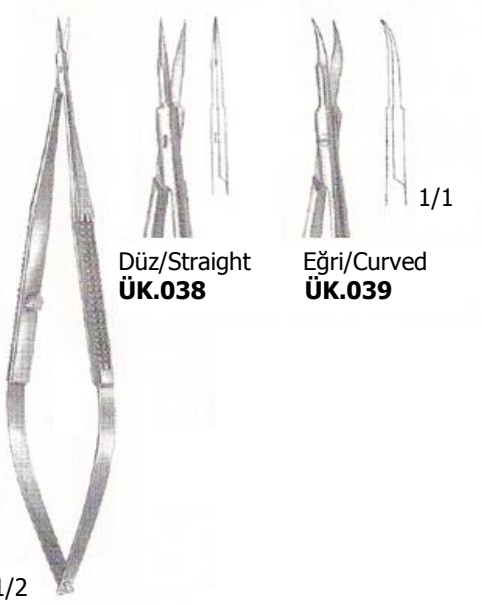

Düz/Straight
ÜK.038

Eğri/Curved
ÜK.039

1/2

16 cm

ÜK.038 – ÜK.039

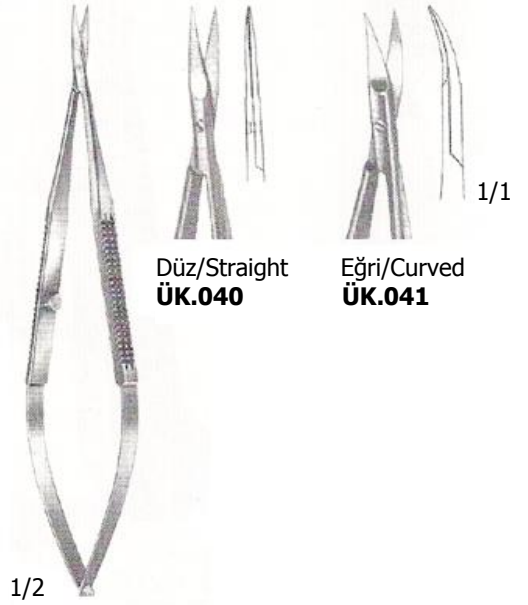

Düz/Straight
ÜK.040

Eğri/Curved
ÜK.041

1/2

Çift Ağız Tırtıllı/Both Jaws Serrated

16 cm ÜK.040 – ÜK.041

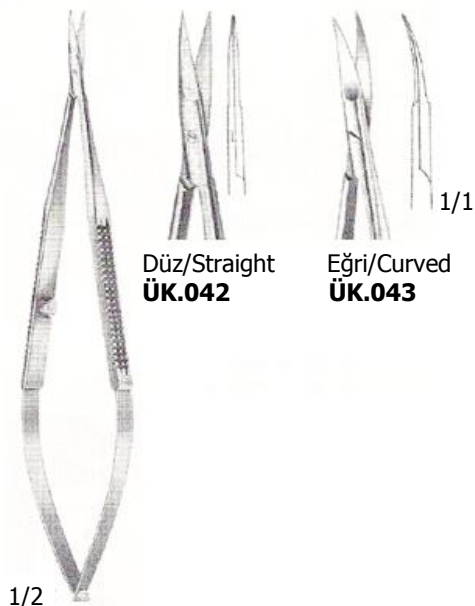

Düz/Straight
ÜK.042

Eğri/Curved
ÜK.043

1/2

16 cm

ÜK.042 – ÜK.043

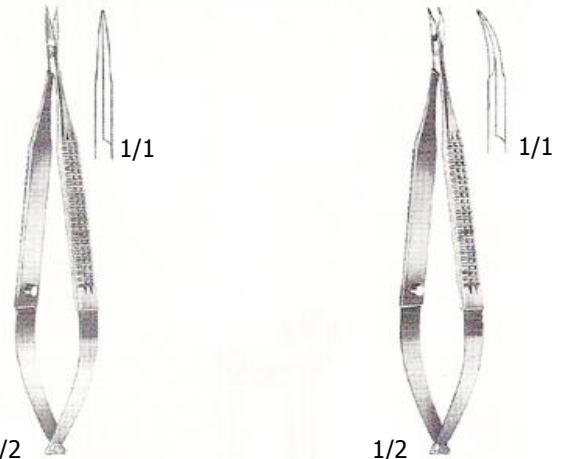

Düz/Straight – 12 cm
ÜK.044

Eğri/Curved – 12 cm
ÜK.045

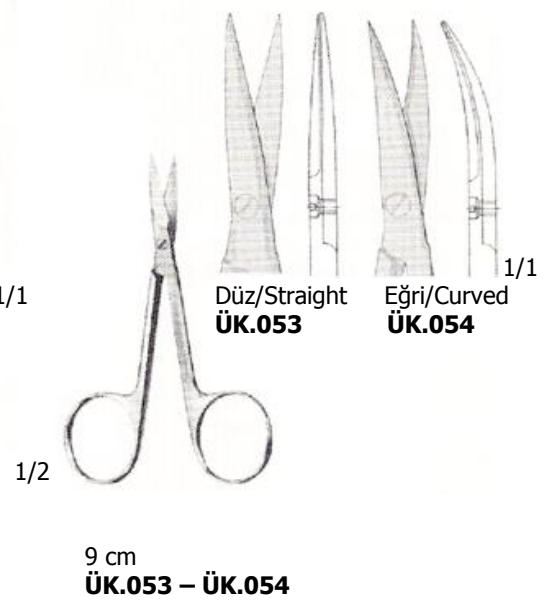
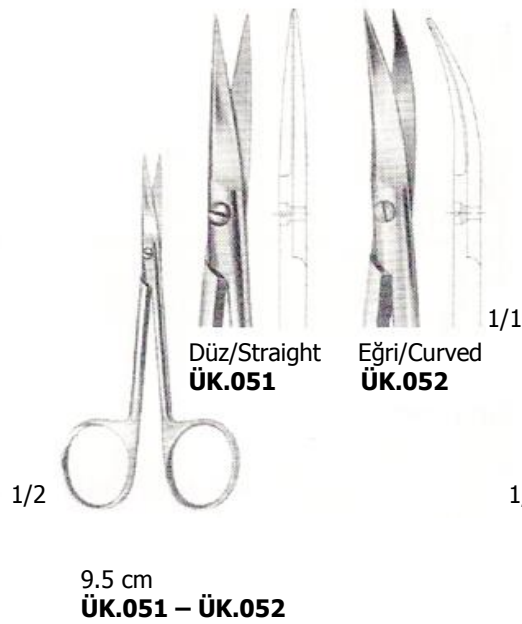
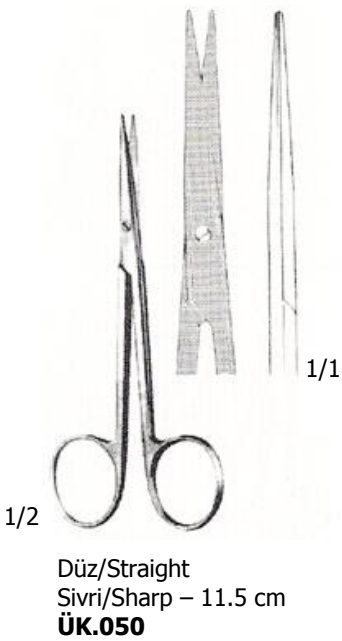
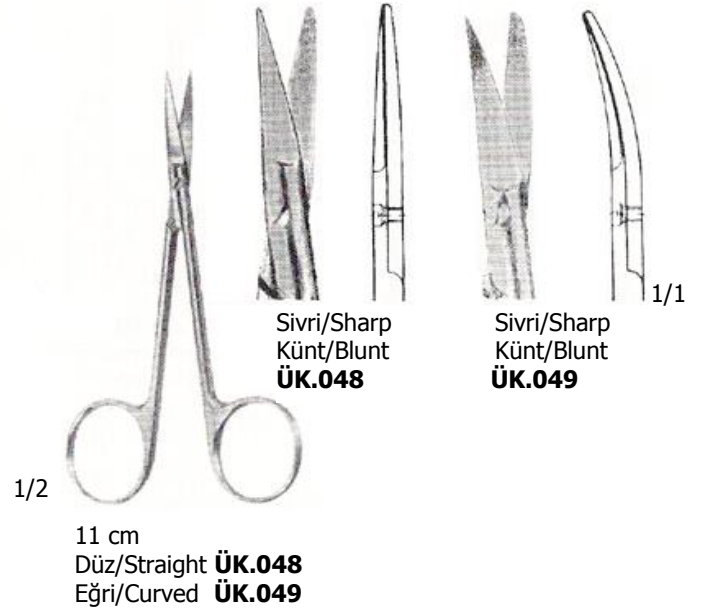
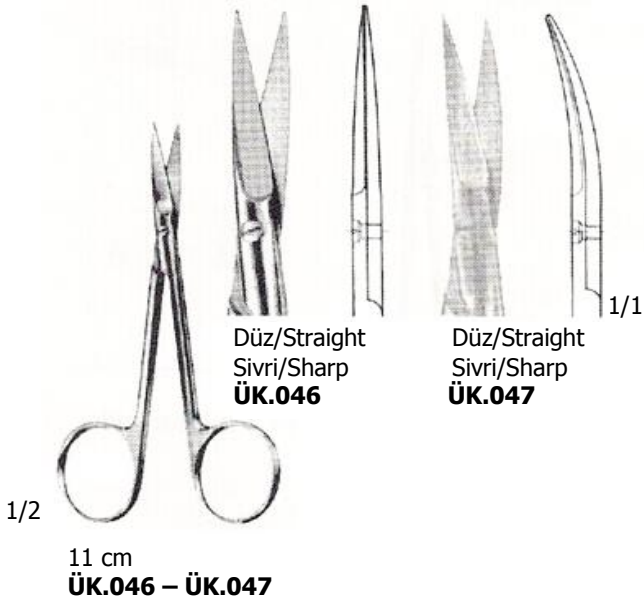

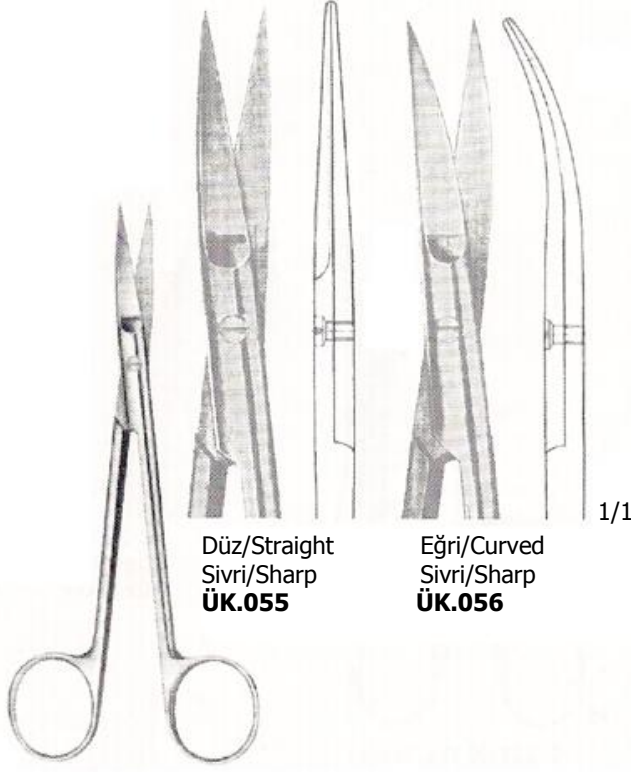

Düz/Straight
Sivri/Sharp
ÜK.055

Eğri/Curved
Sivri/Sharp
ÜK.056

1/2

1/1

JOSEPH – 15 cm
ÜK.055 – ÜK.056

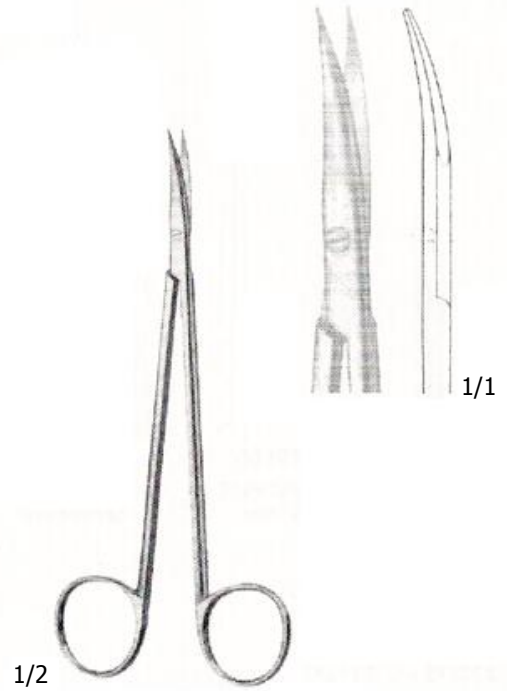

1/2

1/1

Eğri/Curved – 15 cm
ÜK.057



Düz/Straight
Sivri/Sharp
ÜK.058

Eğri/Curved
Sivri/Sharp
ÜK.059

Eğri/Curved
Künt/Blunt
ÜK.060

1/2

1/1

12 cm
ÜK.058 – ÜK.060

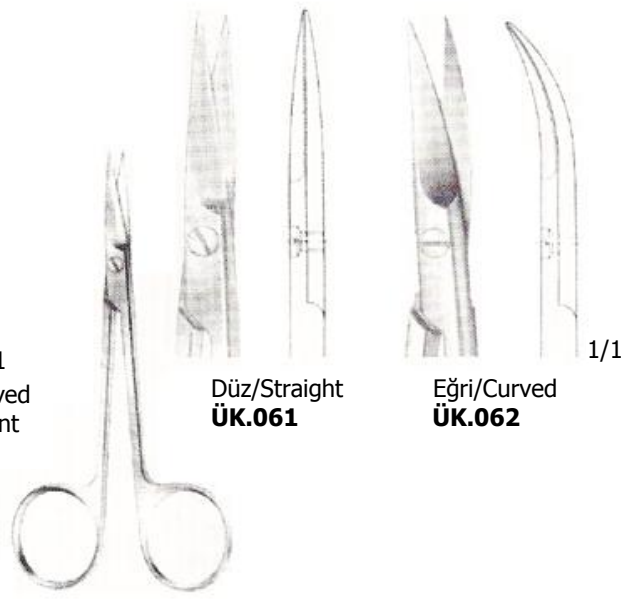

Düz/Straight
ÜK.061

Eğri/Curved
ÜK.062

1/2

1/1

12 cm
ÜK.061 – ÜK.062

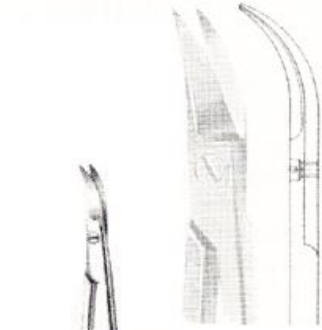

1/1

1/2

CHADWICK – 11.5 cm
ÜK.063

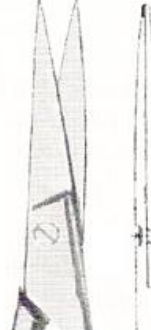

1/1

1/2

11 cm
ÜK.064

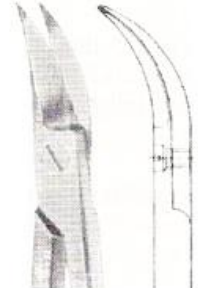

1/1

1/2

QUINBY – 13 cm
ÜK.065

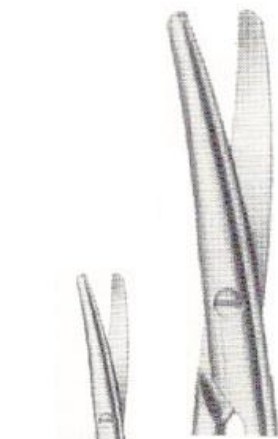

1/2

LANDOLT – 12 cm
ÜK.066 – ÜK.067



ÜK.066

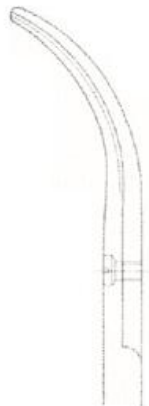

ÜK.067

1/1



FOMON
ÜK.068 – ÜK.069



Eğri/Curved
Sivri/Sharp
11.5 cm
ÜK.068

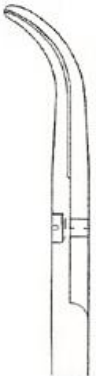
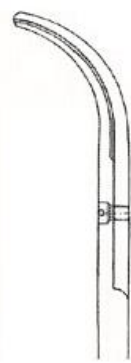

Eğri/Curved
Sivri/Sharp
13.5 cm
ÜK.069

1/1

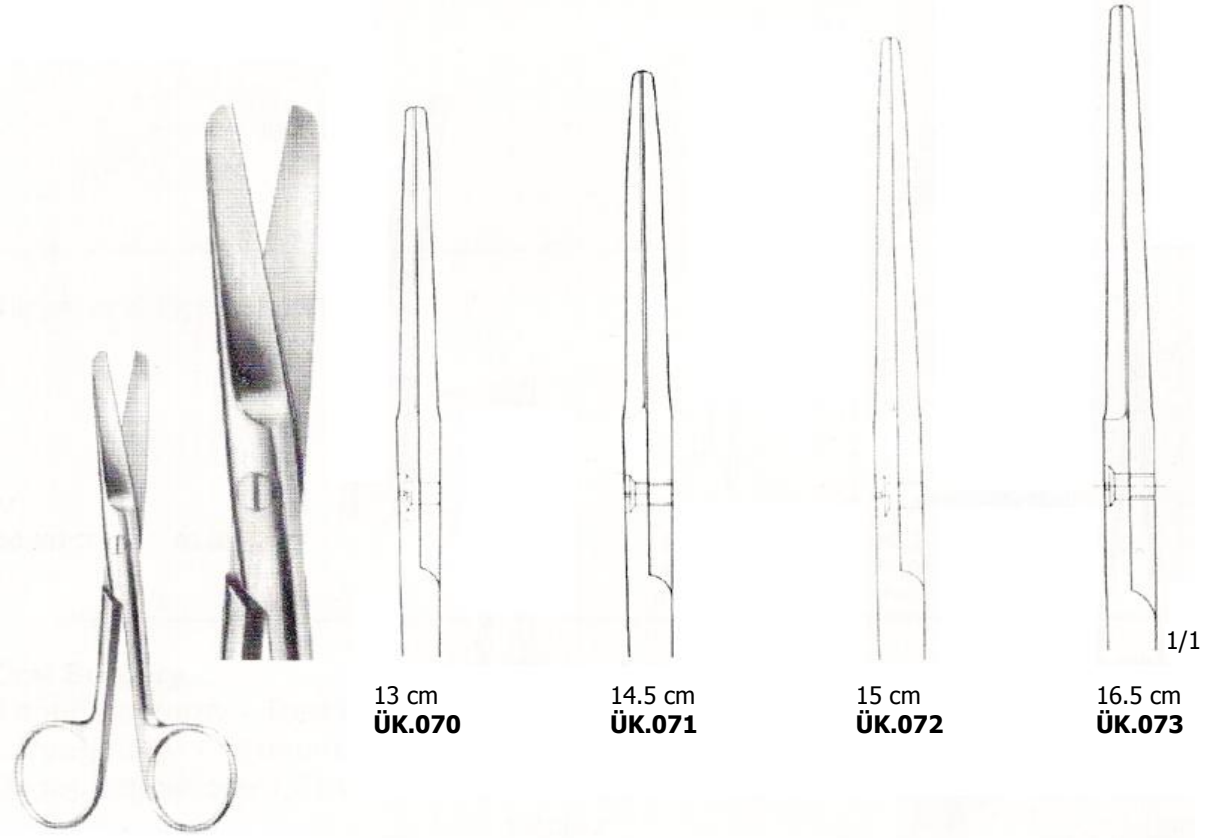

Künt/Blunt
Düz/Straight
ÜK.070 – ÜK.073

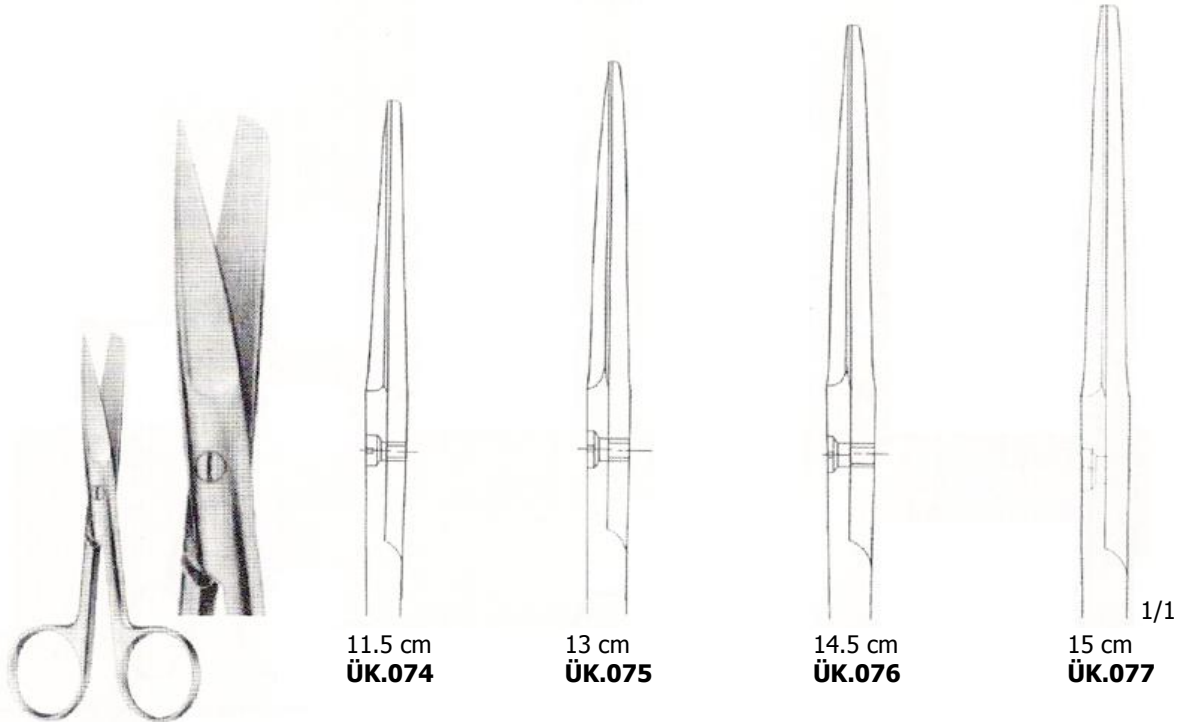

Sivri/Künt, Düz
Sharp/Blunt, Straight
ÜK.074 – ÜK.077

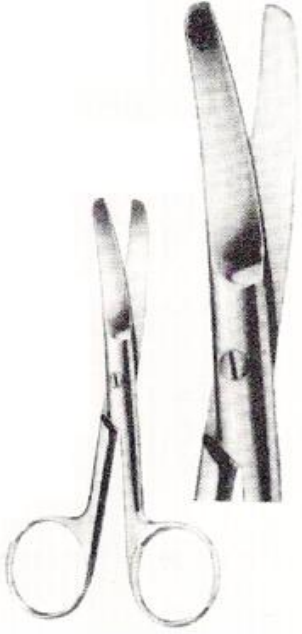

COOPER
Künt/Blunt
Eğri/Curved
ÜK.078 – ÜK.082



11.5 cm
ÜK.078



13 cm
ÜK.079



14.5 cm
ÜK.080



15 cm
ÜK.081

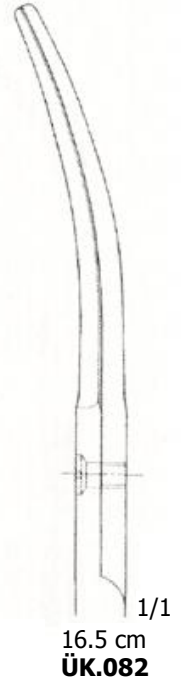

16.5 cm
ÜK.082

1/1

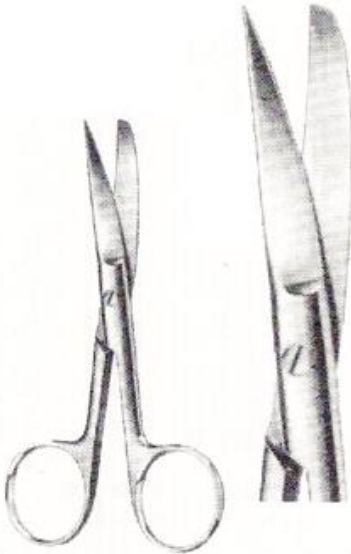

Sivri/Künt, Eğri
Sharp/Blunt, Curved
ÜK.083 – ÜK.087



11.5 cm
ÜK.083



13 cm
ÜK.084



14.5 cm
ÜK.085



15 cm
ÜK.086

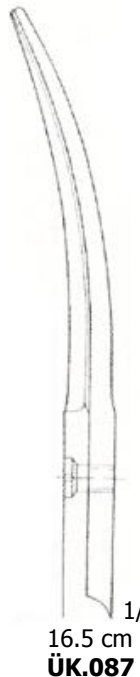

16.5 cm
ÜK.087

1/1



Sivri/Künt, Eğri
Sharp/Blunt, Curved
ÜK.088 – ÜK.089

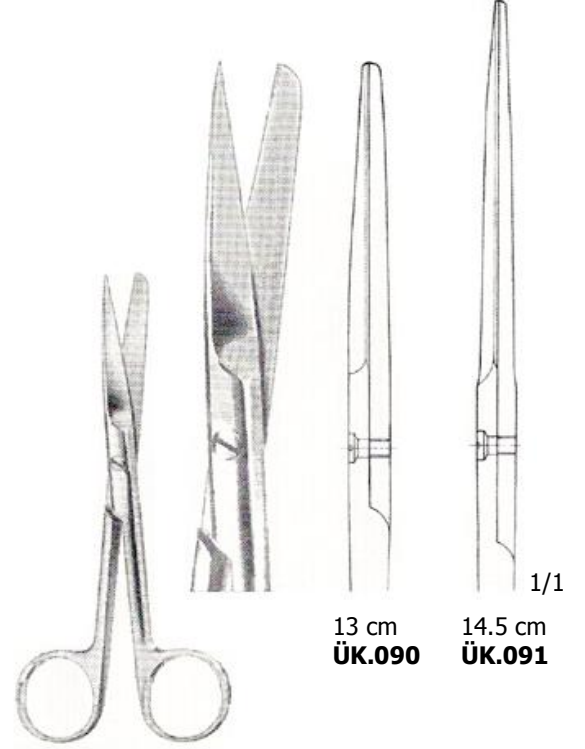

Sivri/Künt, Düz
Sharp/Blunt, Straight
ÜK.090 – ÜK.091

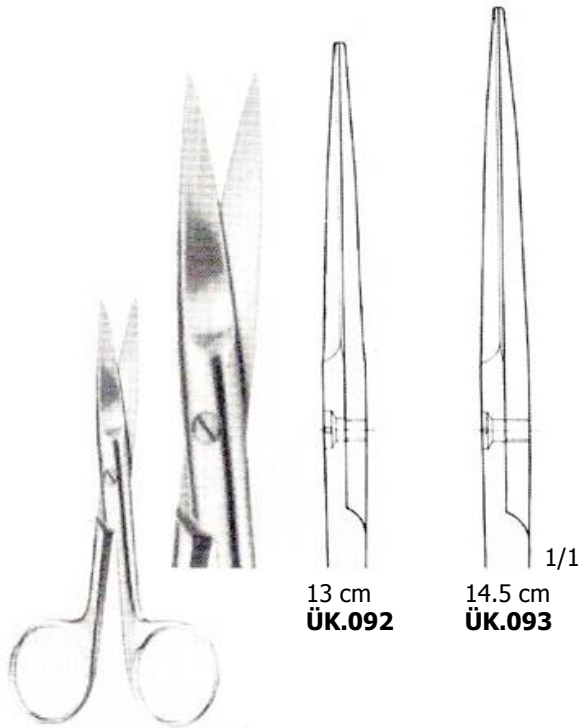

Sivri/Sharp
Düz/Straight
ÜK.092 – ÜK.093

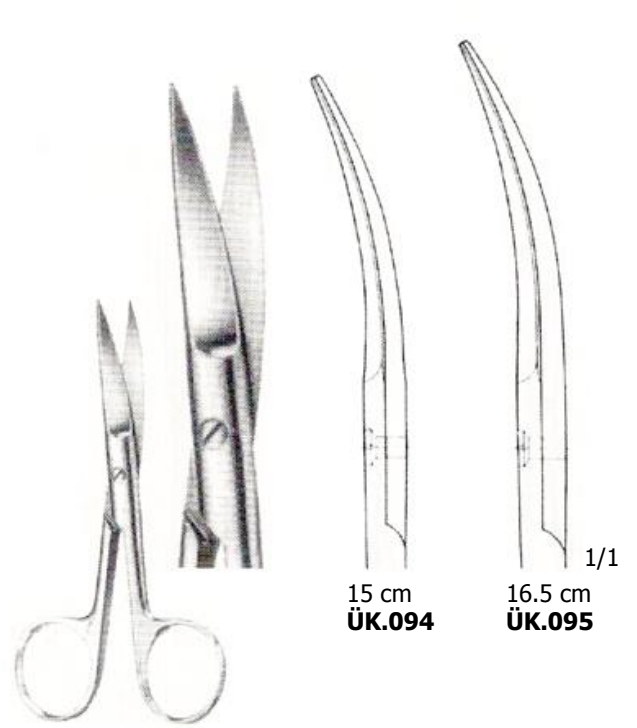

Sivri/Sharp
Eğri/Curved
ÜK.094 – ÜK.095

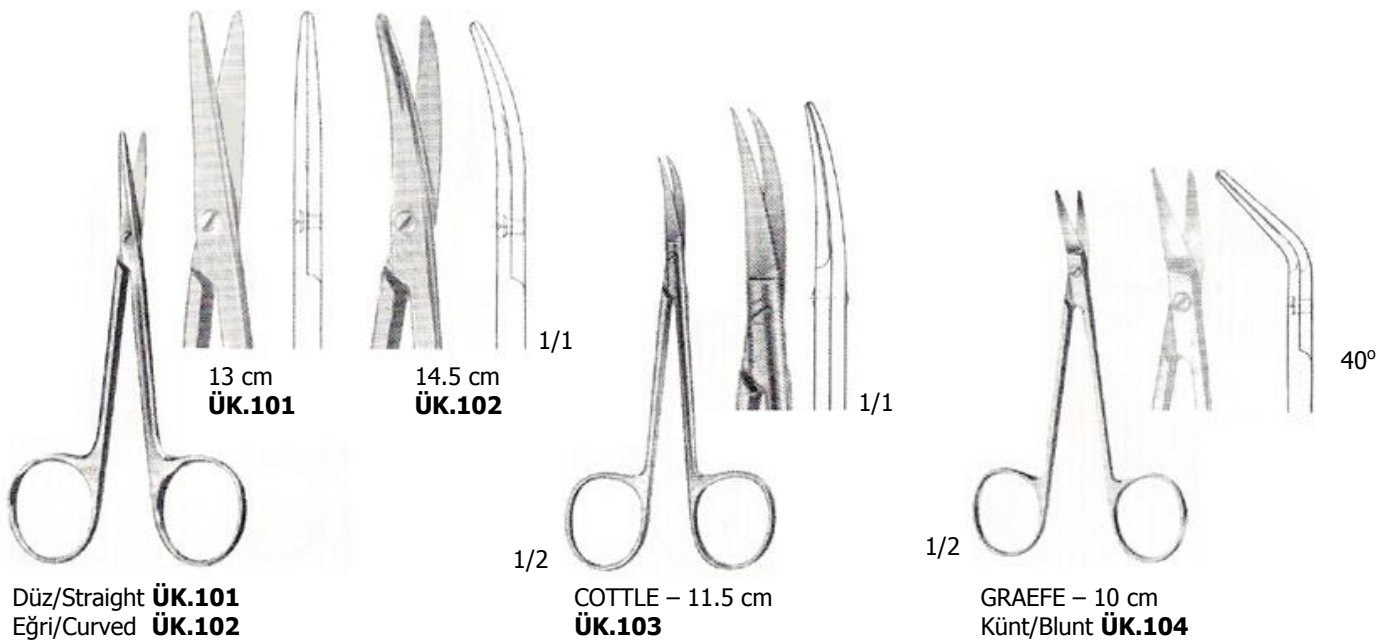
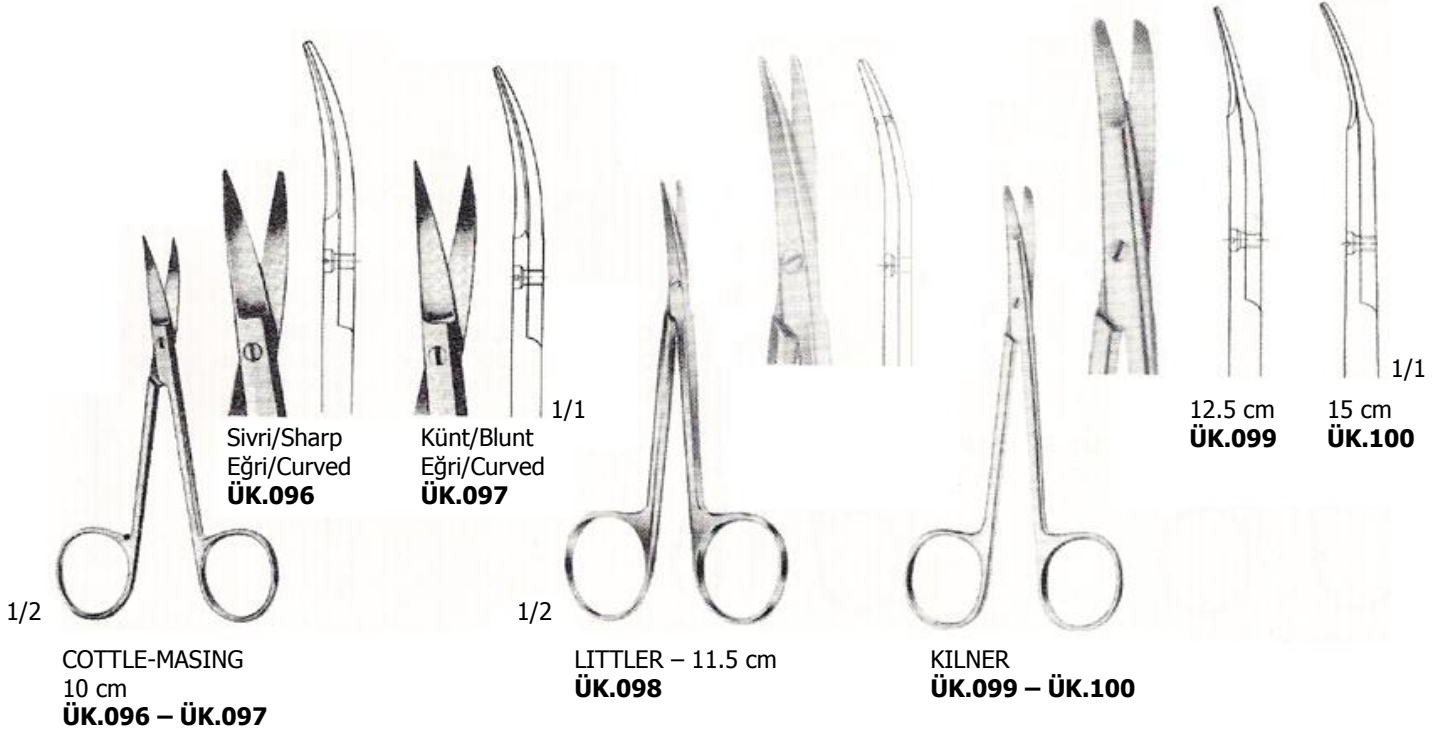

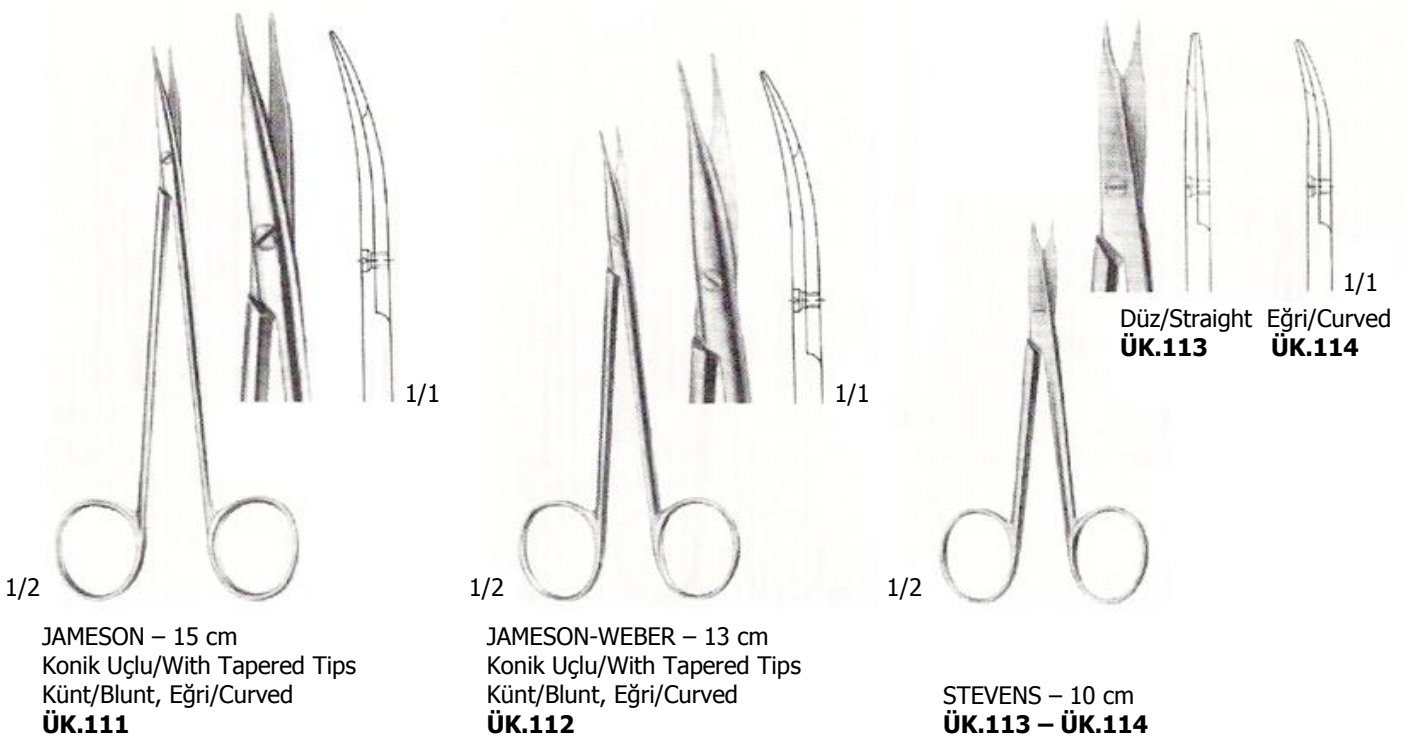
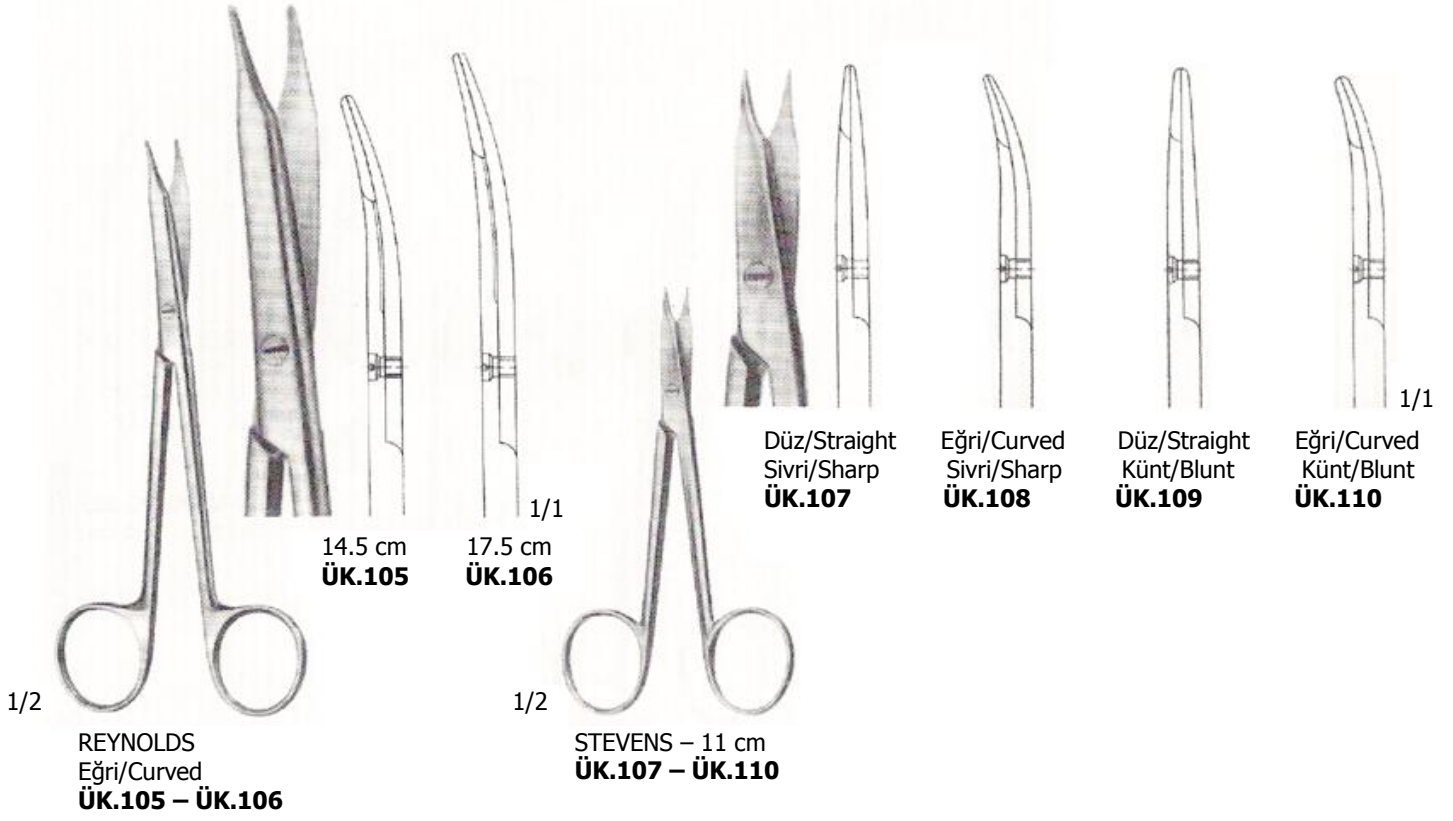

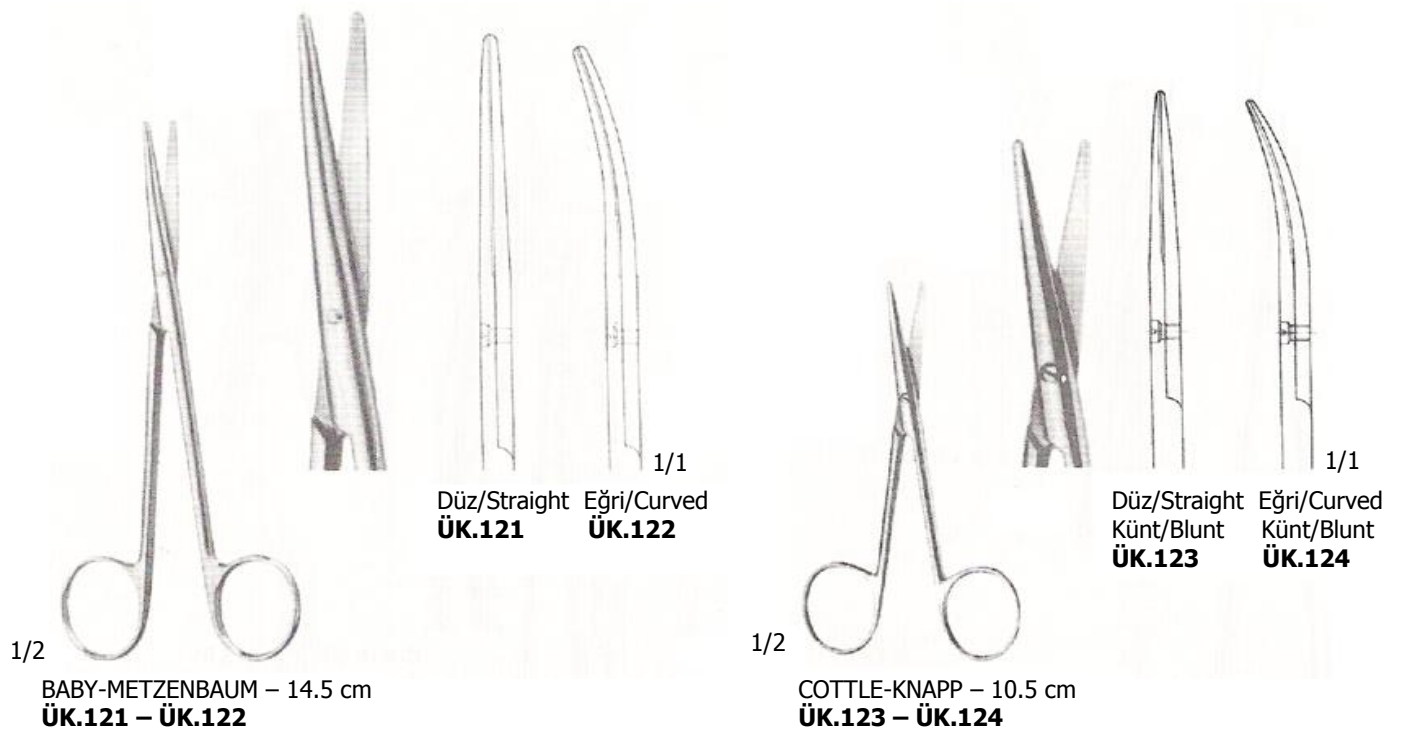
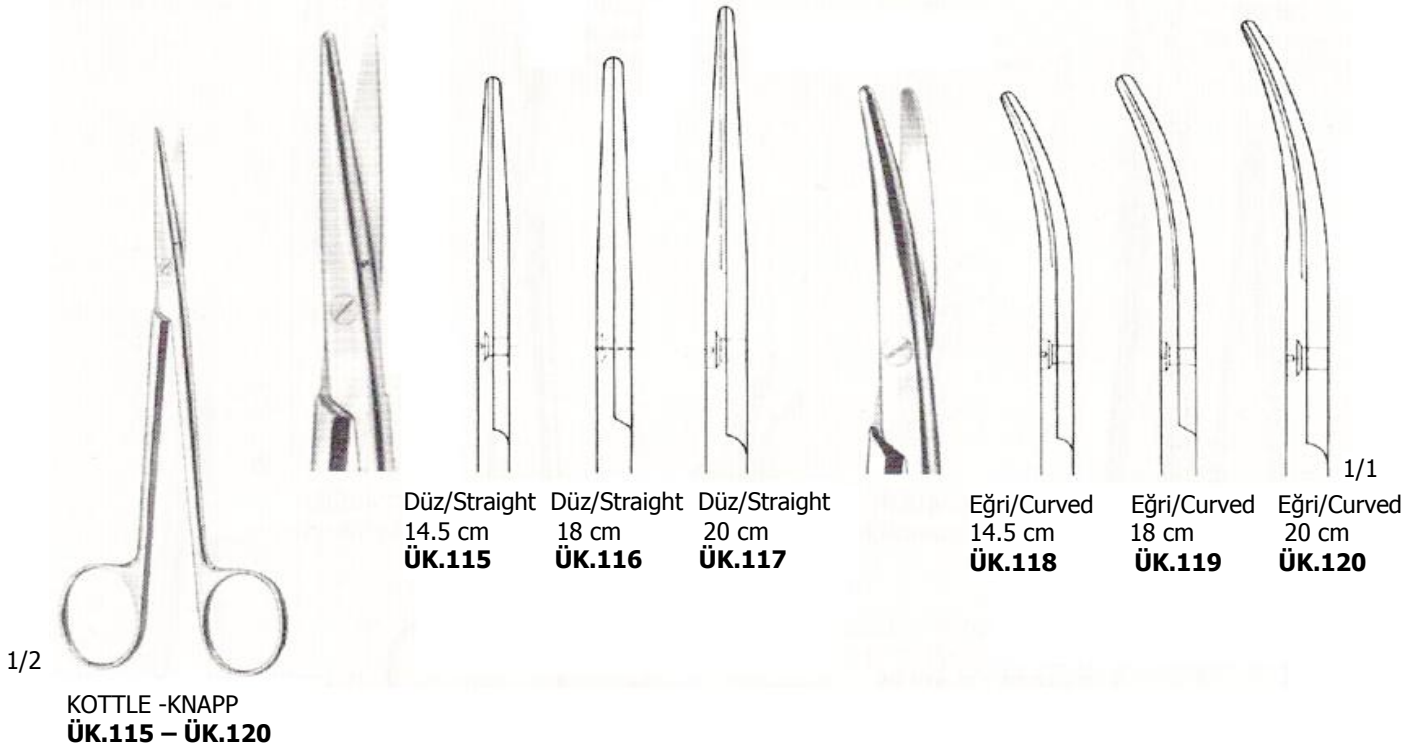

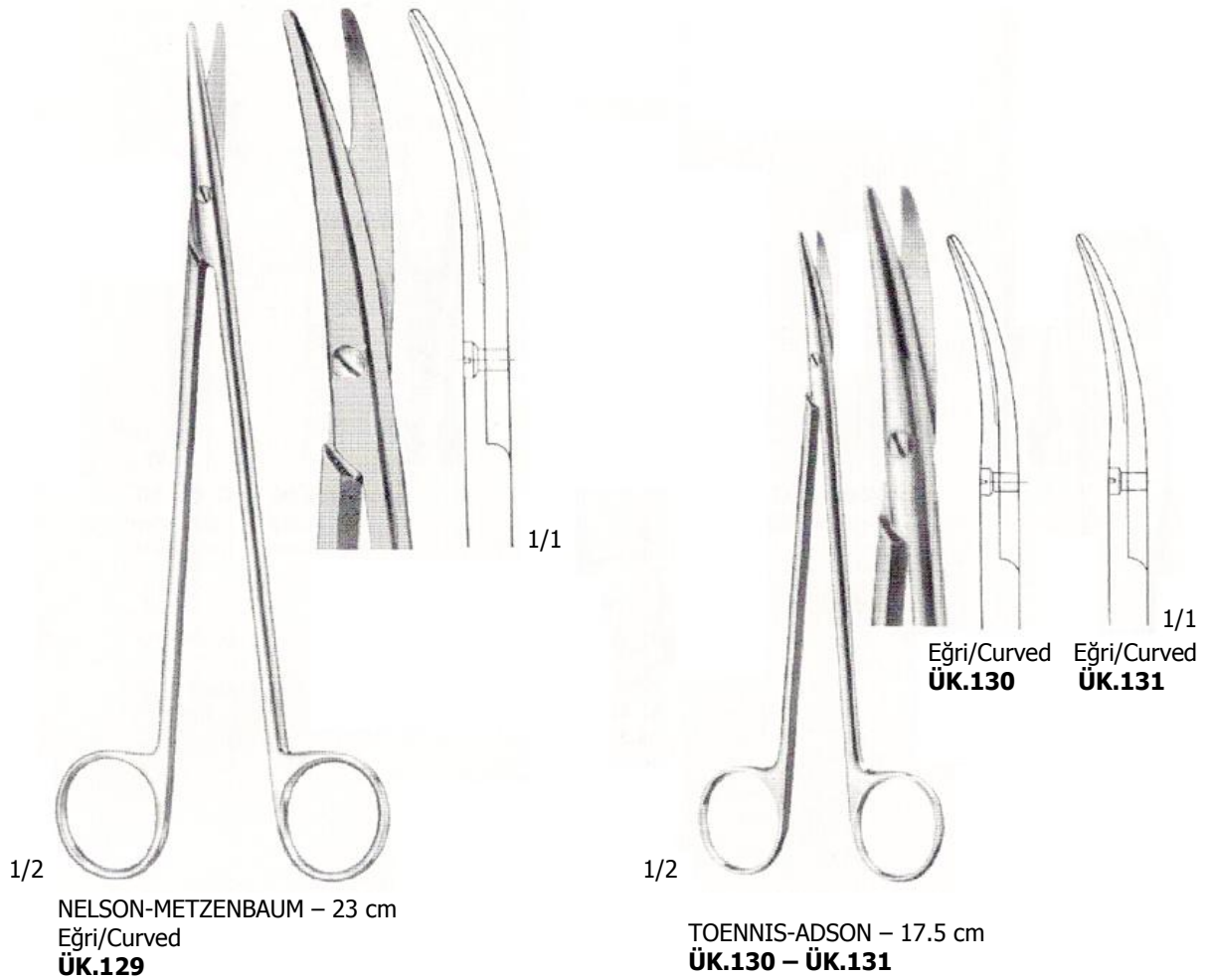

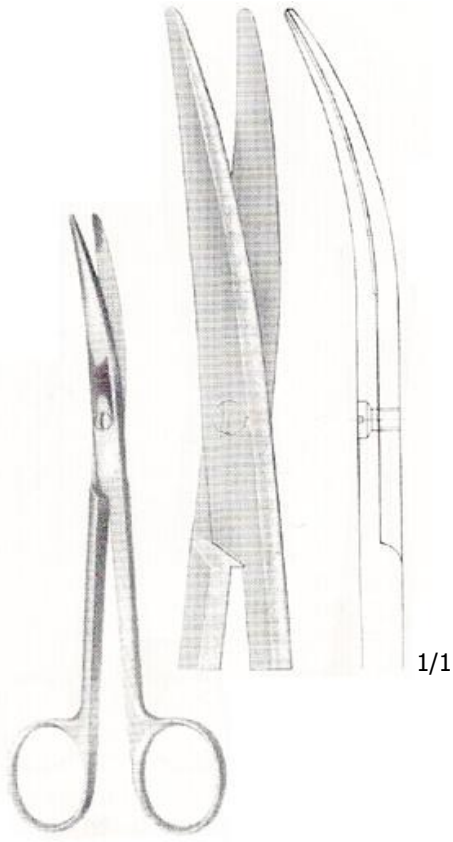

1/2

LEXER – 16.5 cm
Eğri/Curved **ÜK.132**

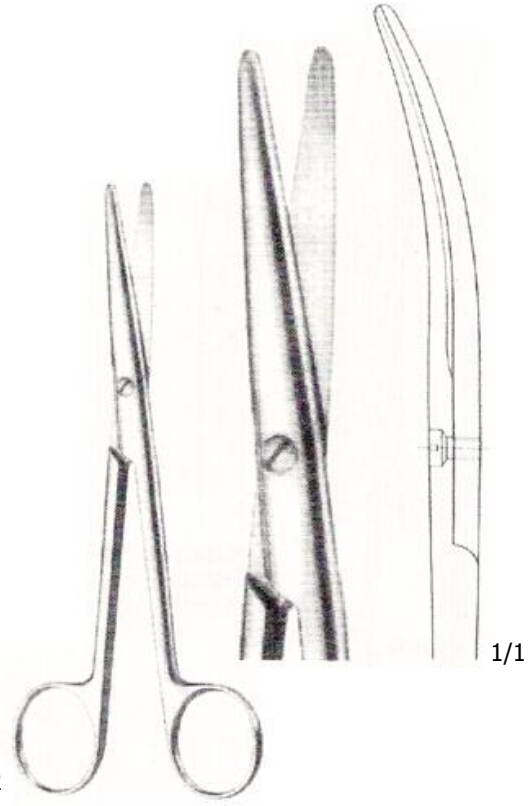

1/2

MAYO – 21 cm
Eğri/Curved **ÜK.133**



1/2

MAYO
ÜK.134 – ÜK.136

Düz/Straight
15.5 cm
ÜK.134

Eğri/Curved
15.5 cm
ÜK.135

Eğri/Curved
17 cm
ÜK.136

1/1

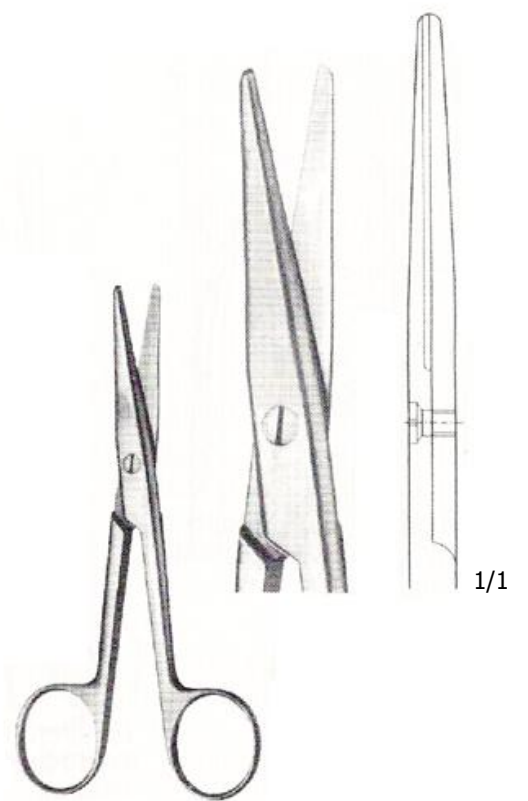

1/2

MAYO-STILLE – 17 cm
Düz/Straight **ÜK.137**

1/1

Sert Metal Ağızlı/Hard Metal Edged

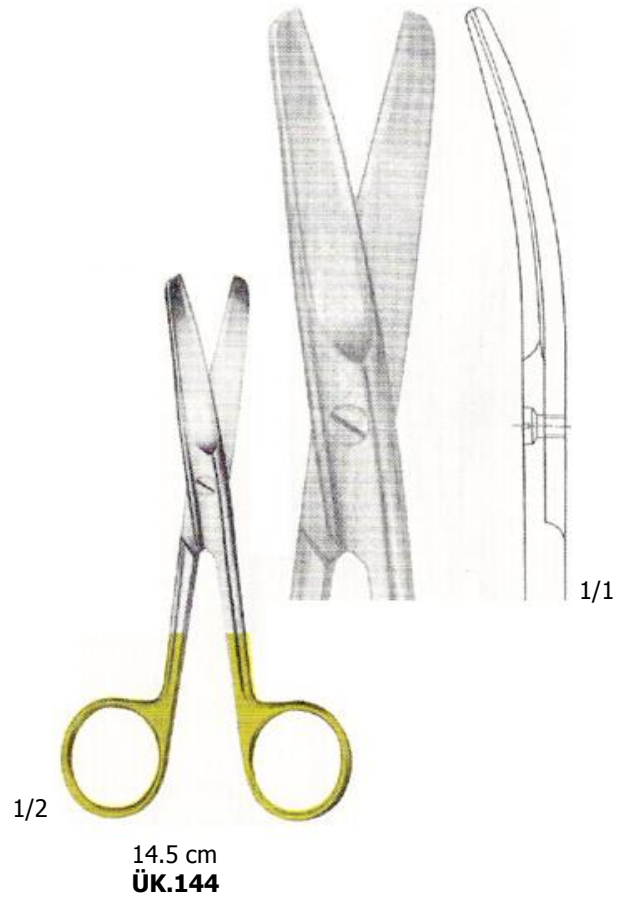
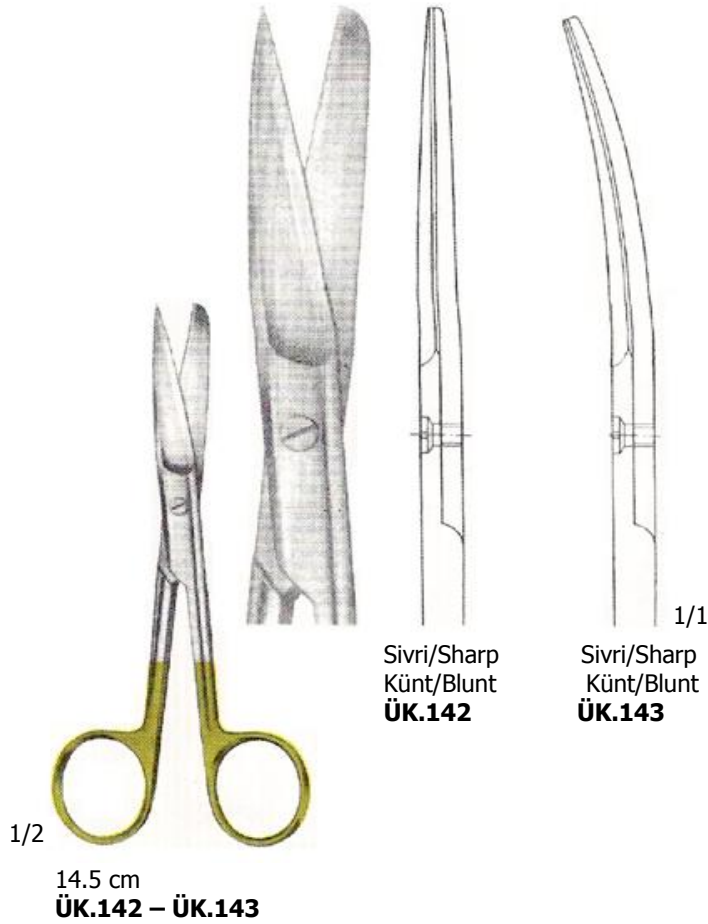
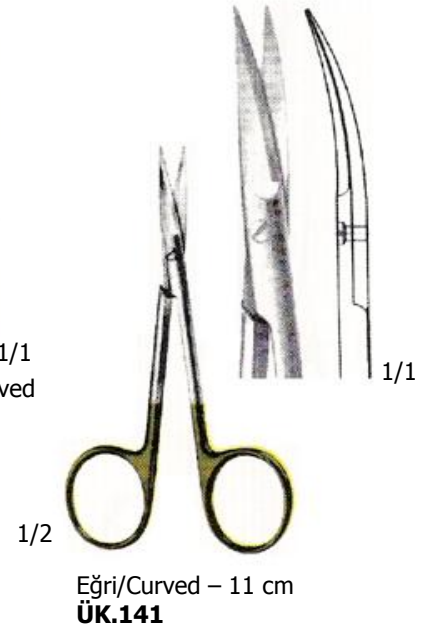
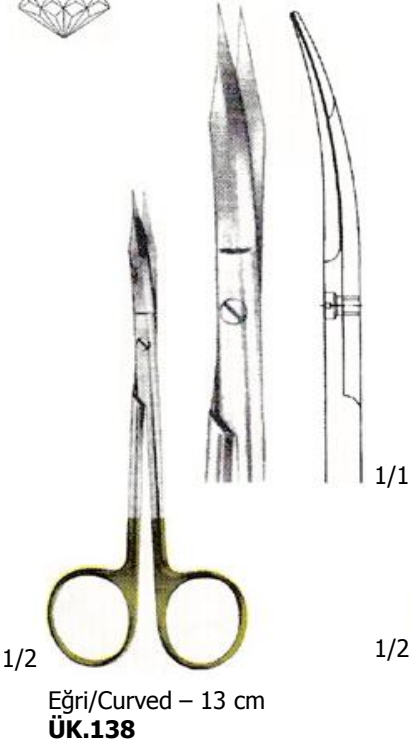

Sert Metal Ağızlı/Hard Metal Edged



1/2

BABY-METZENBAUM – 14.5 cm
ÜK.145 – ÜK.146

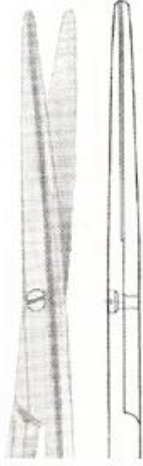

Düz/Straight
ÜK.145

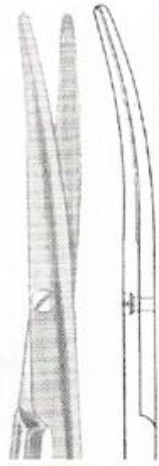

Eğri/Curved
ÜK.146

1/1



1/2

11.5 cm
ÜK.147 – ÜK.148

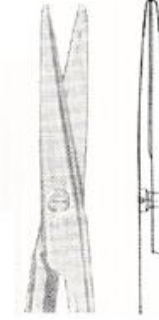

Düz/Straight
ÜK.147

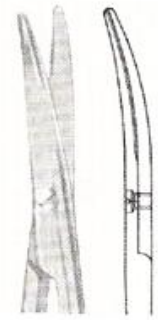

Eğri/Curved
ÜK.148

1/1

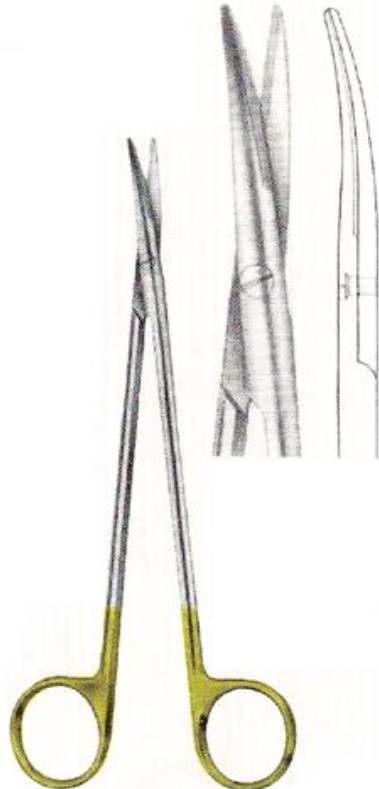

1/2

TOENNIS-ADSON – 17.5 cm
Eğri/Curved ÜK.149

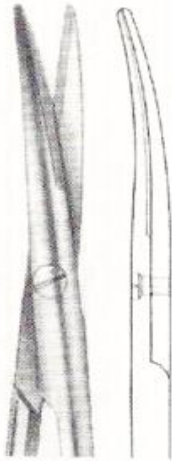

1/1



1/2

METZENBAUM
ÜK.150 – ÜK.153



Düz/Straight
14.5 cm
ÜK.150

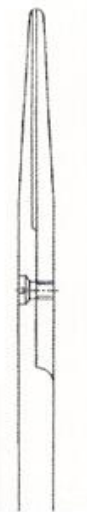

Düz/Straight
18 cm
ÜK.151



Düz/Straight
18 cm
ÜK.151



Eğri/Curved
14.5 cm
ÜK.152



Eğri/Curved
14.5 cm
ÜK.152



Eğri/Curved
18 cm
ÜK.153

1/1

Sert Metal Ağızlı/Hard Metal Edged

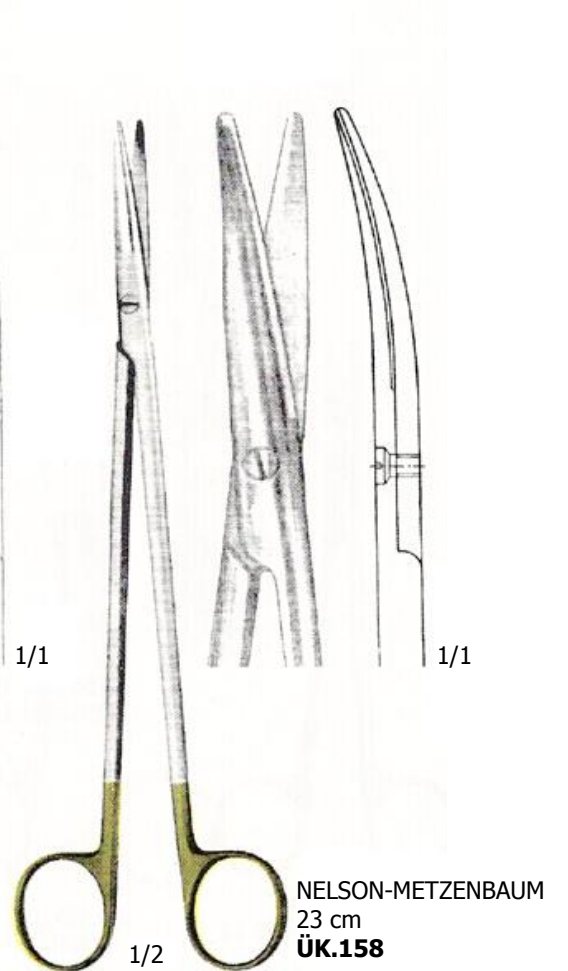
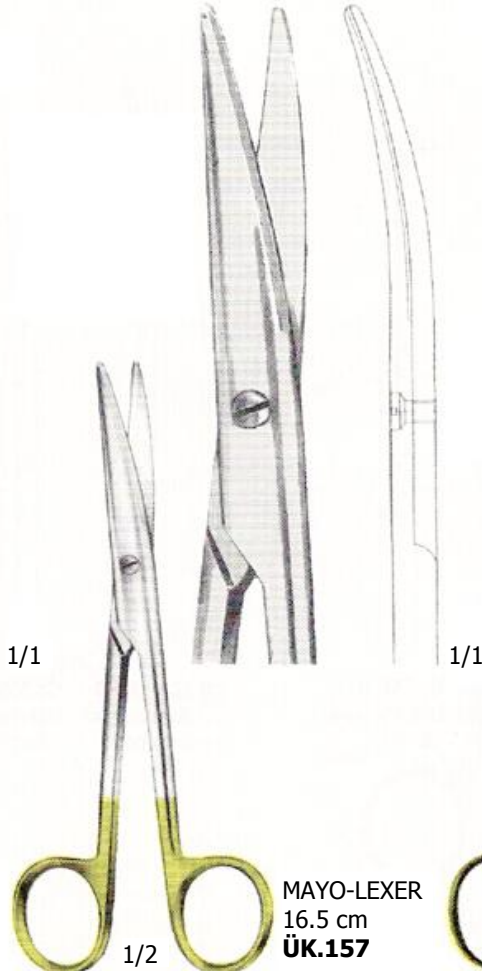
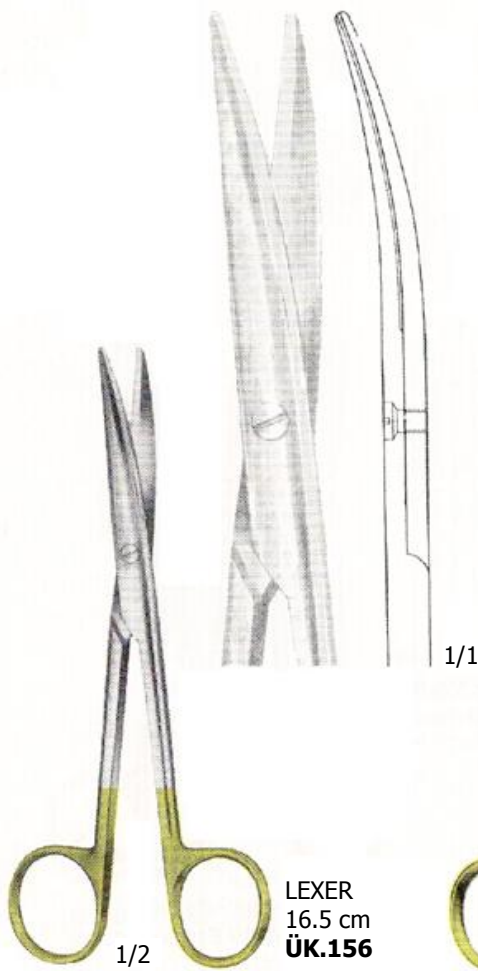
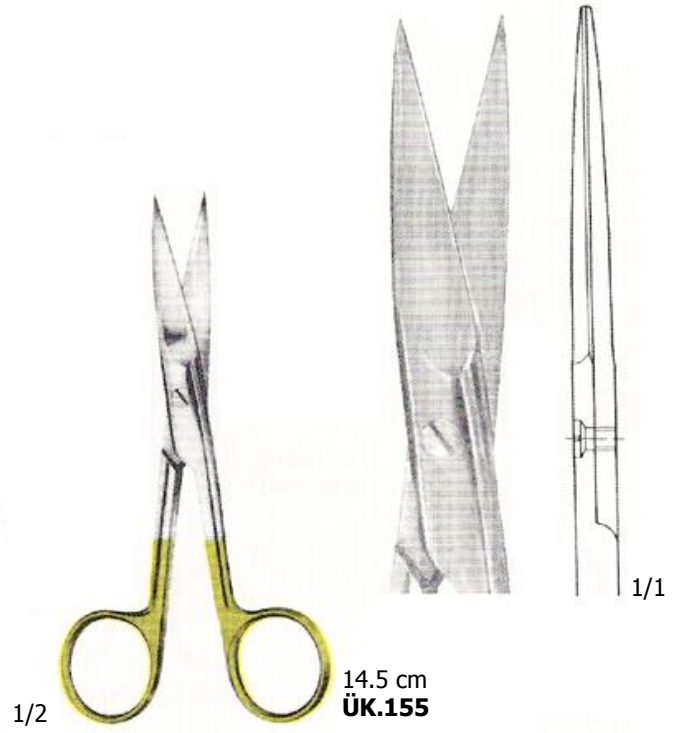
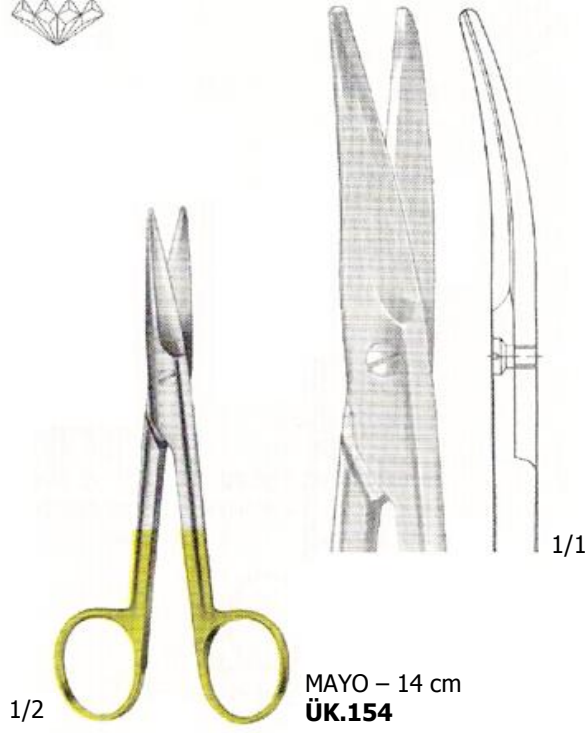

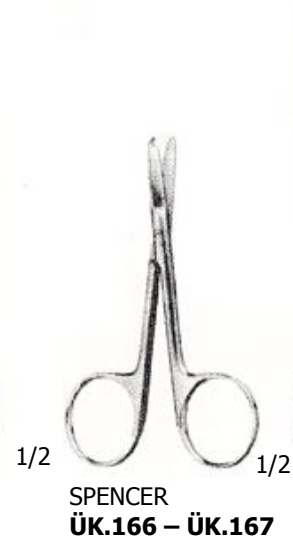
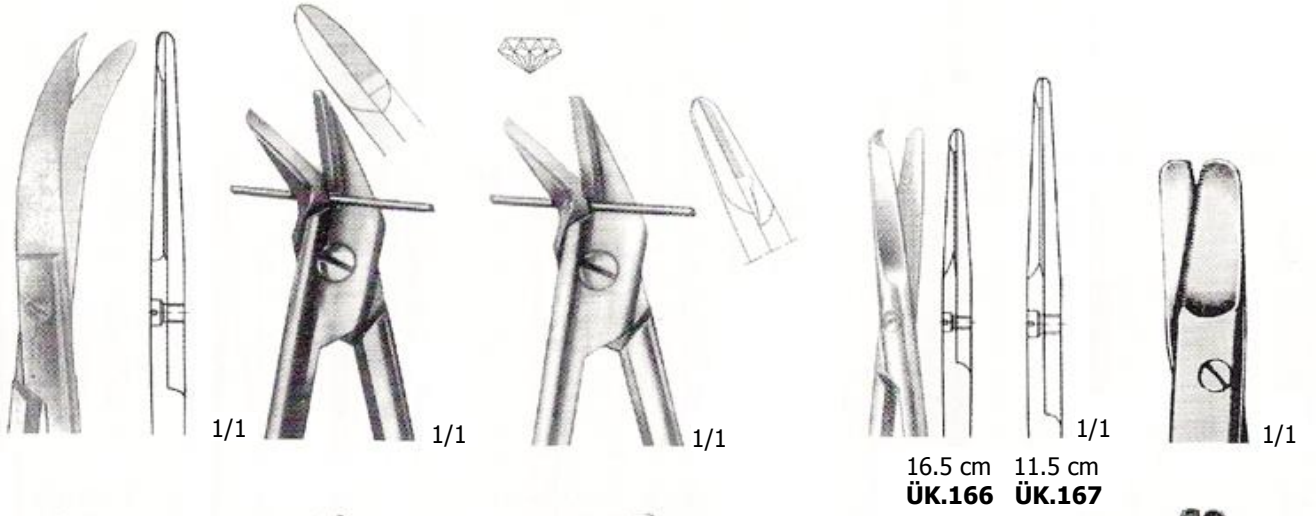
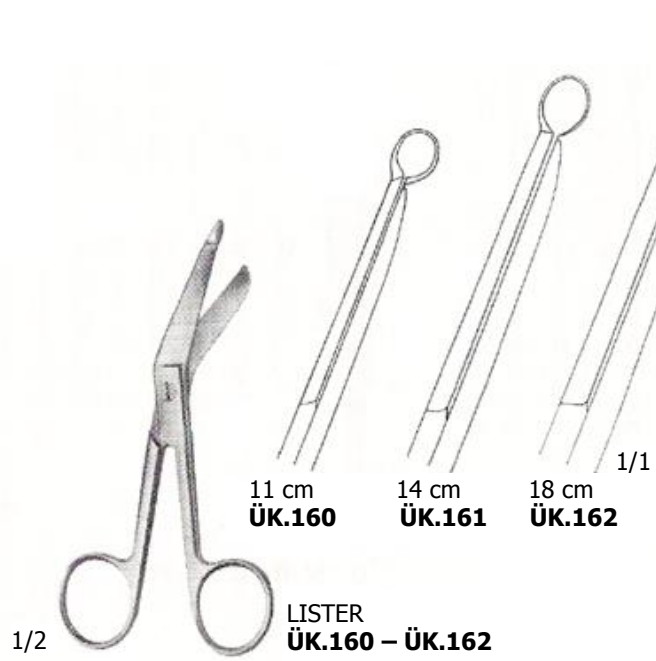
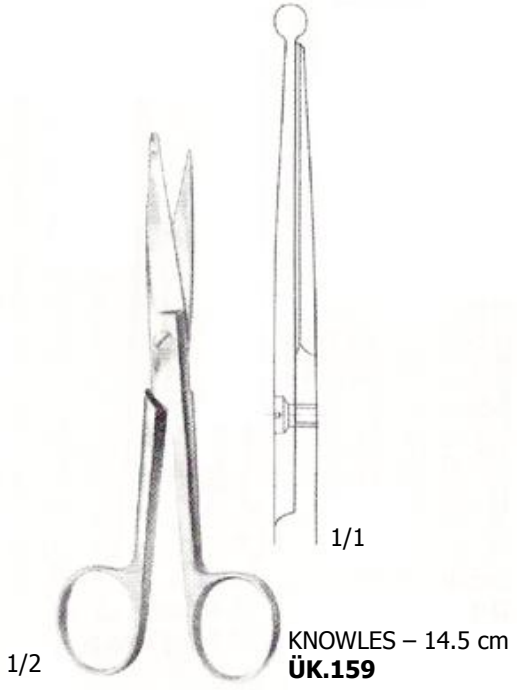

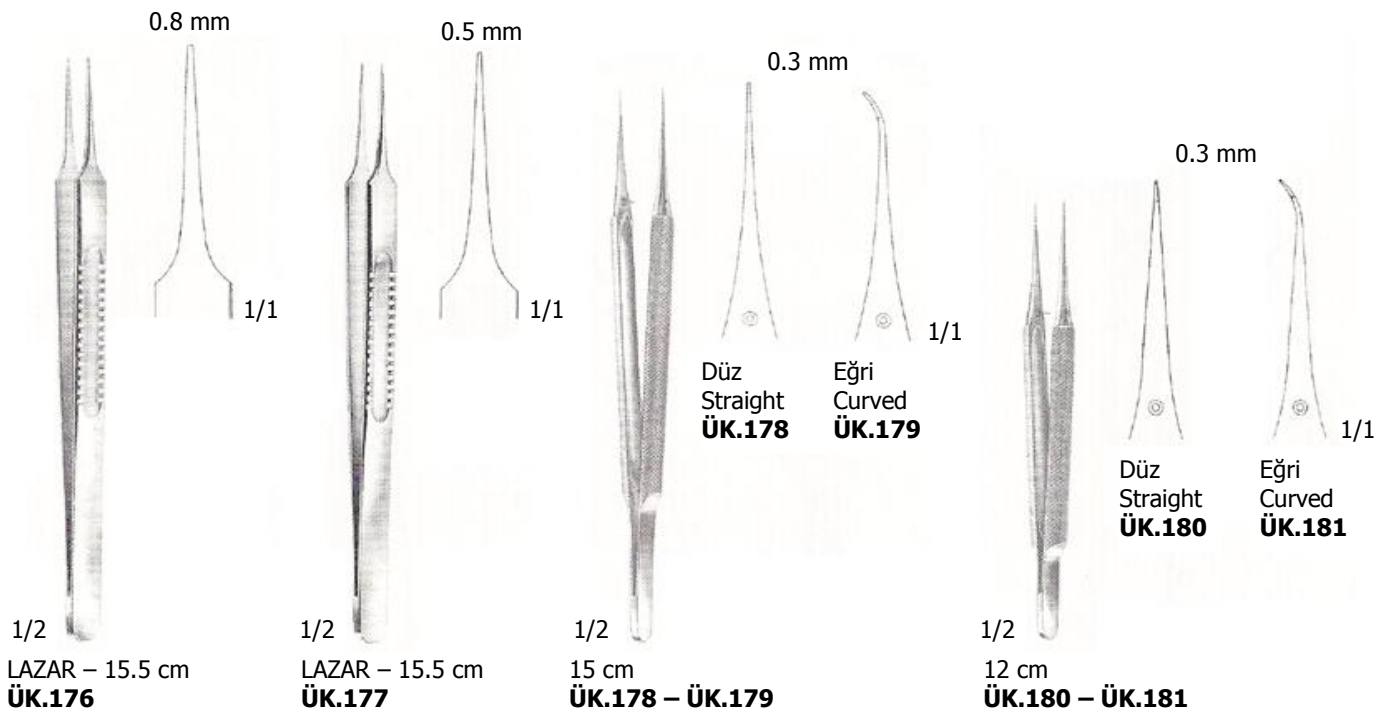
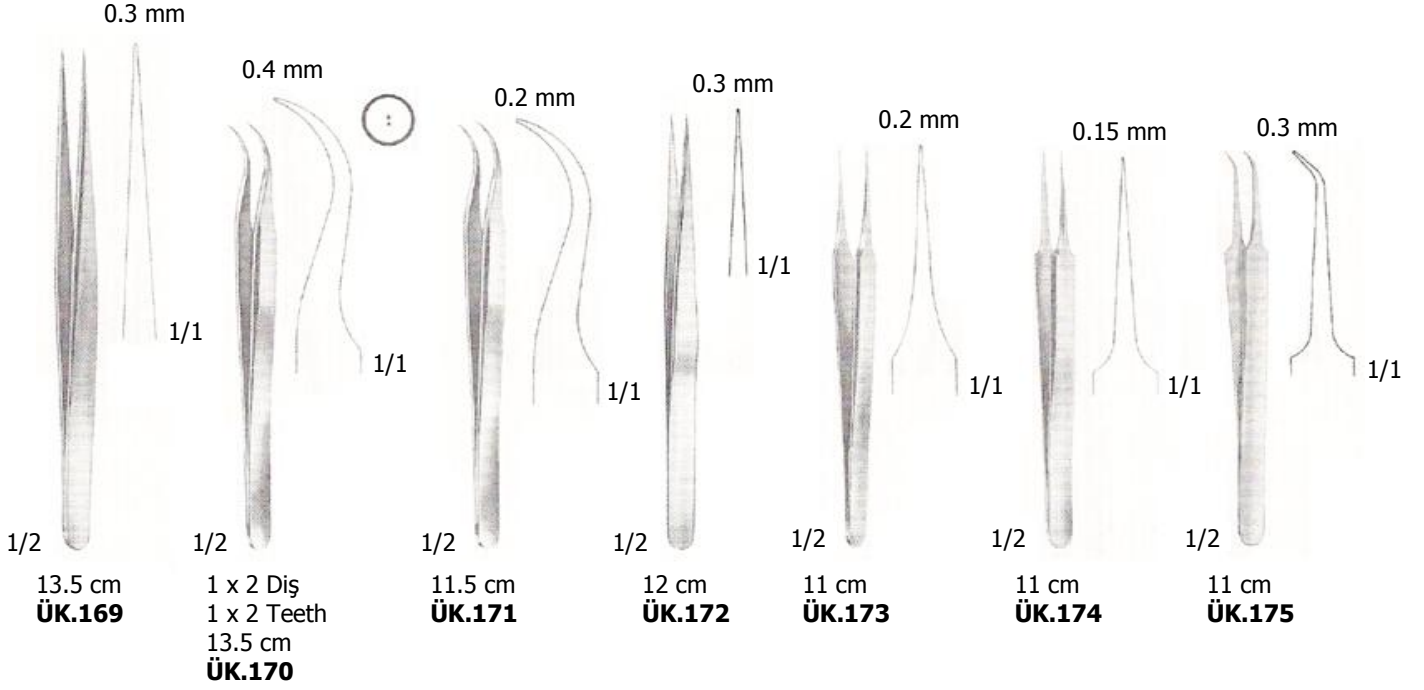

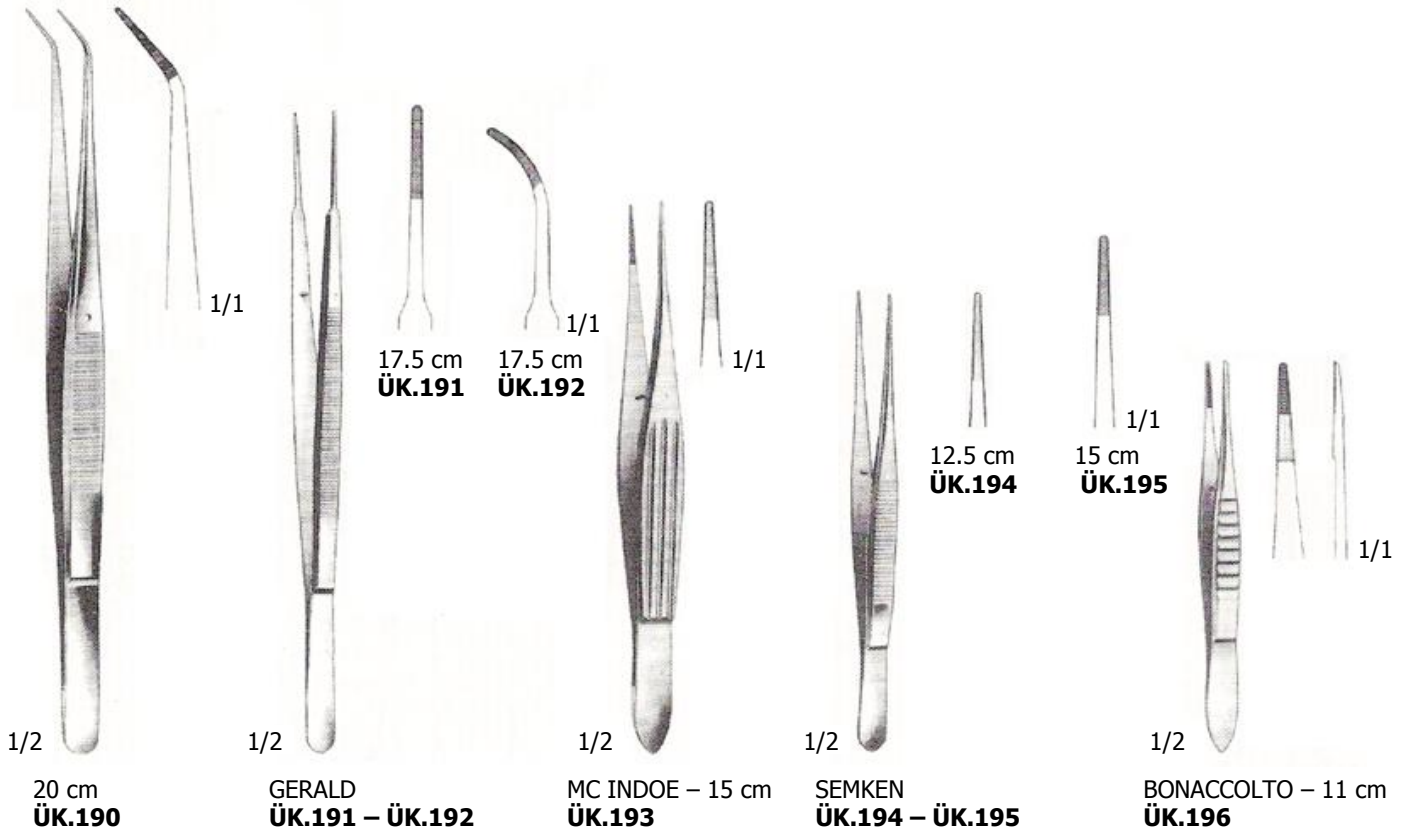
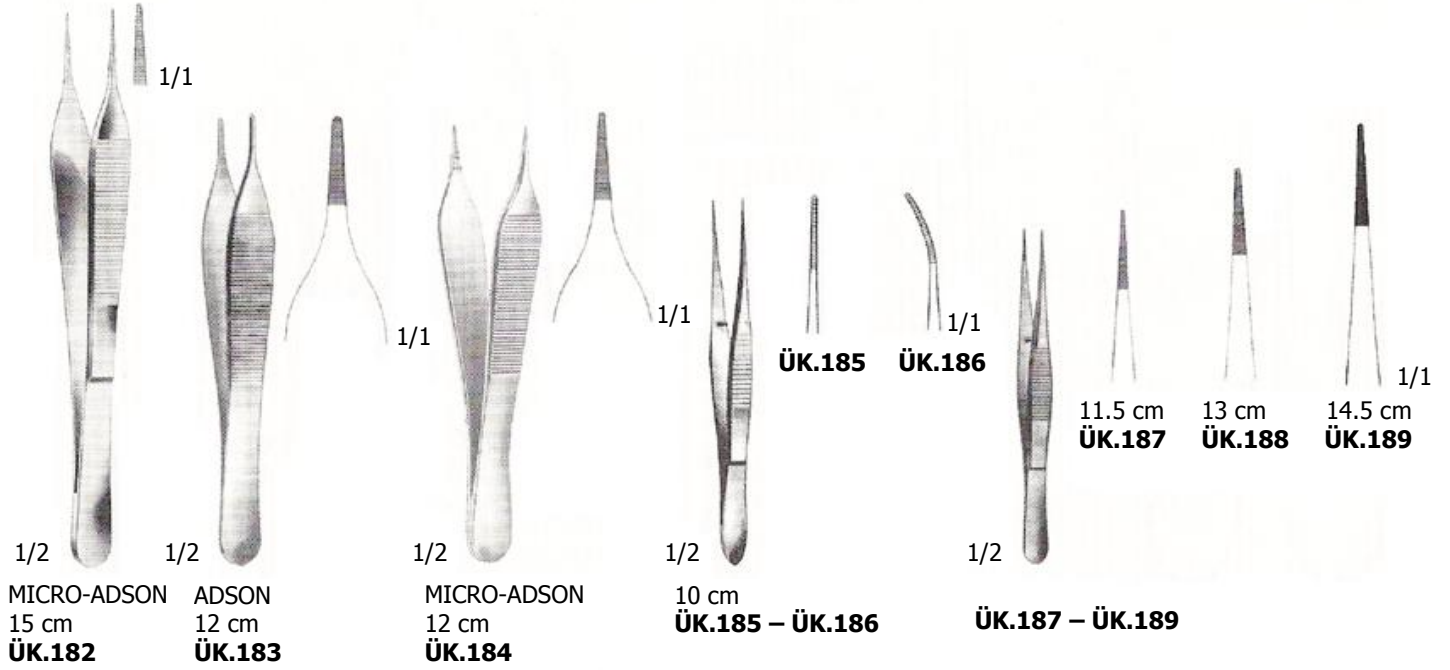

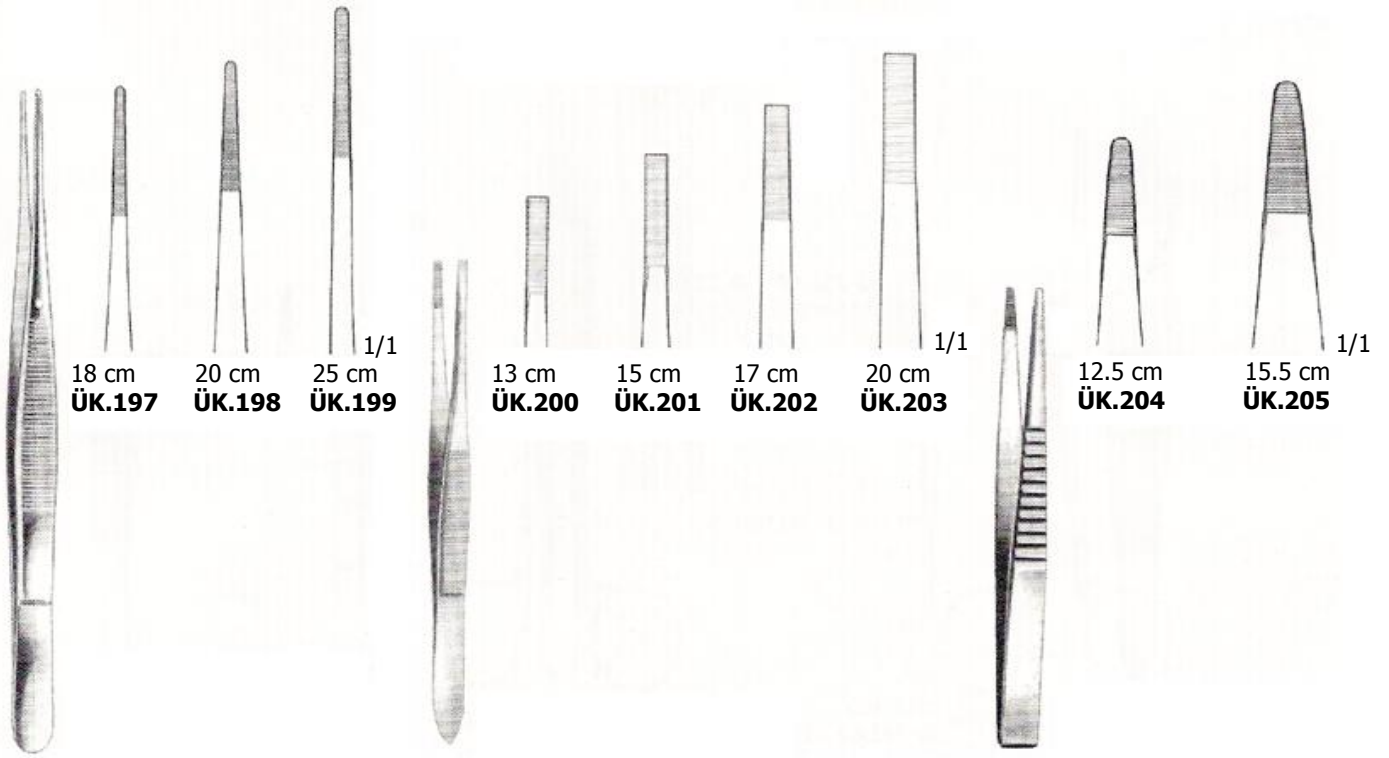

CUSHING
ÜK.197 – ÜK.199

ÜK.200 – ÜK.203

ÜK.204 – ÜK.205

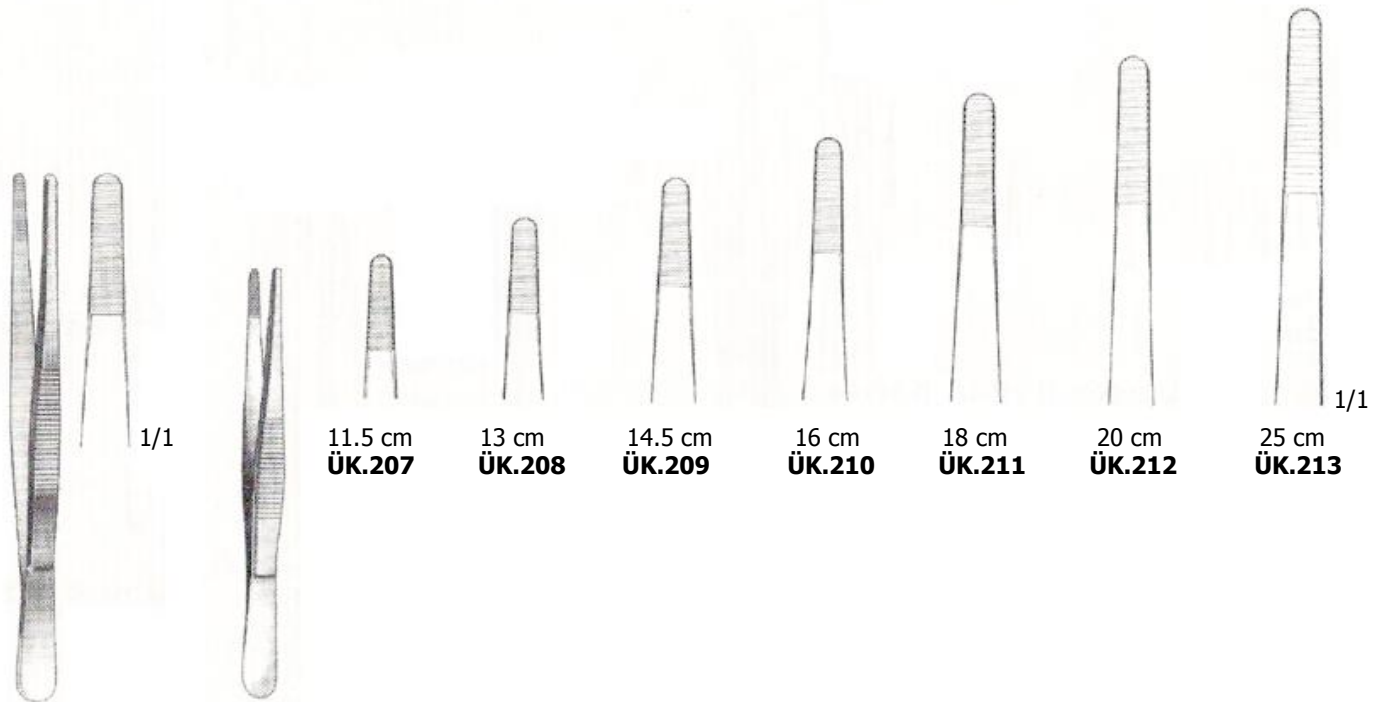

1/2
14.5 cm
ÜK.206

STANDART
ÜK.207 – ÜK.213

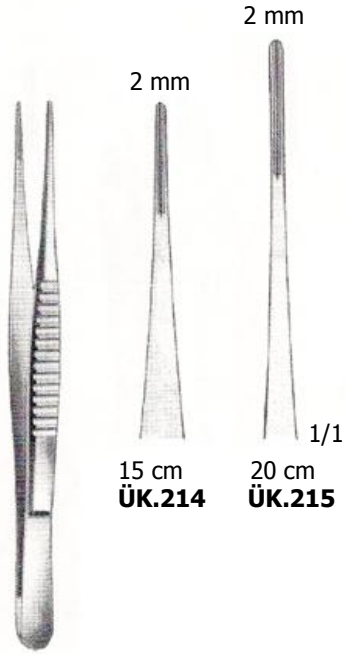

DE BAKEY
ÜK.214 – ÜK.215

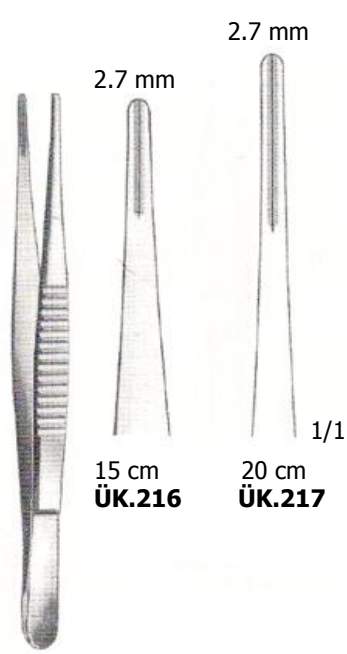

DE BAKEY
ÜK.216 – ÜK.217

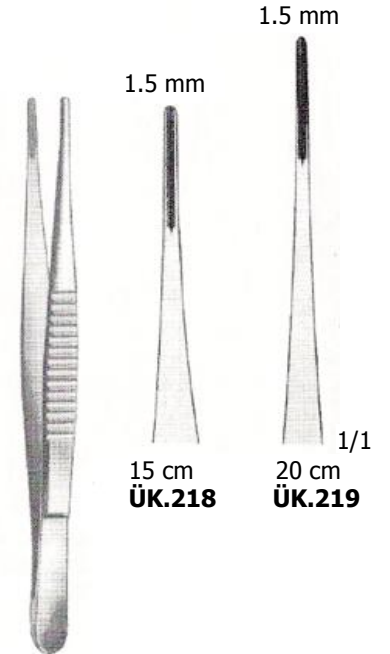

DE BAKEY
ÜK.218 – ÜK.219

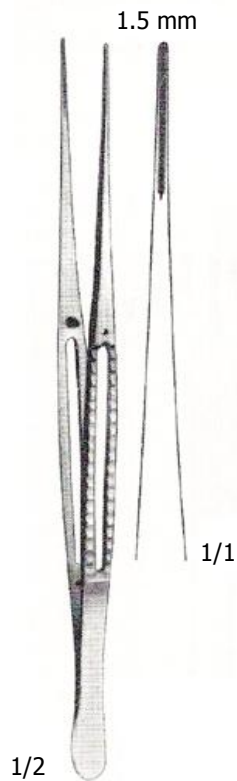

20 cm
ÜK.220

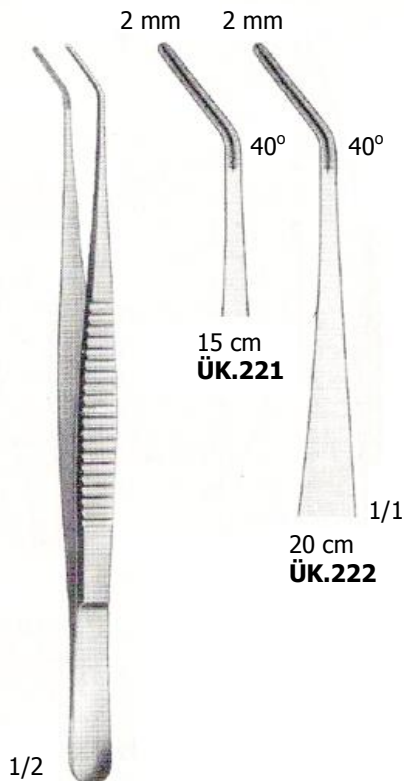

DE BAKEY
ÜK.221 – ÜK.222

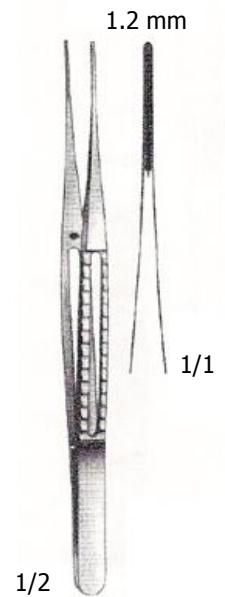

15 cm
ÜK.223

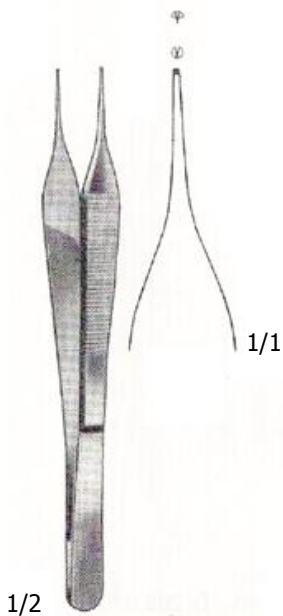

1/2
MICRO-ADSON – 15 cm
ÜK.224

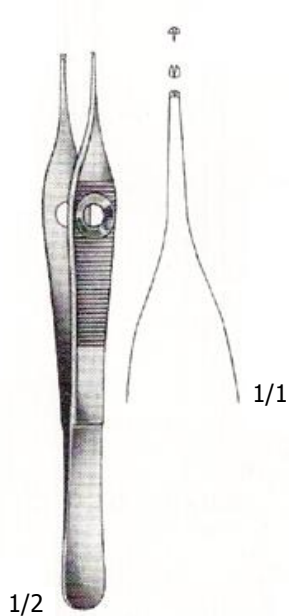

1/2
ADSON – 15 cm
ÜK.225

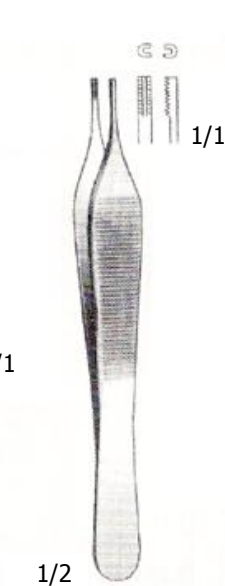

1/2
ADSON-BROWN – 12 cm
ÜK.226



1/2
BROWN – 15 cm
ÜK.227



1/2
COTTLE – 10 cm
ÜK.228

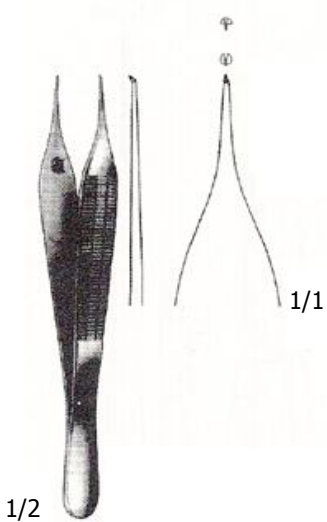

1/2
MICRO-ADSON-BIEMER
12 cm
ÜK.229

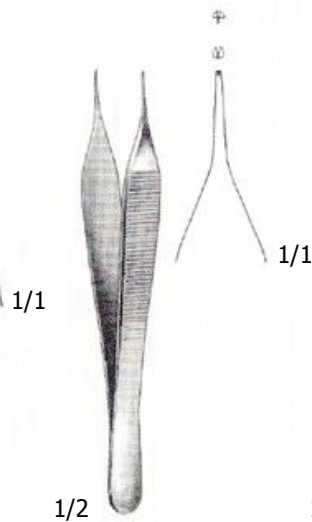

1/2
MICRO-ADSON – 12 cm
ÜK.230

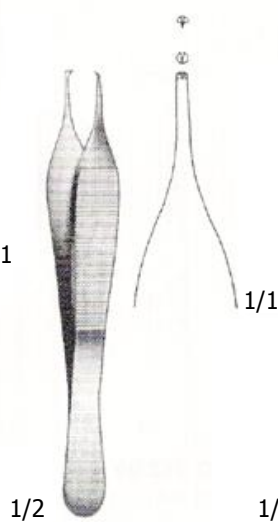

1/2
ADSON – 12 cm
ÜK.231

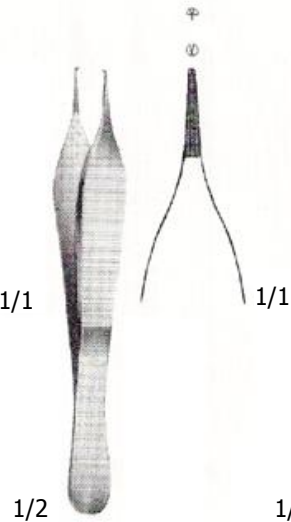

1/2
ADSON – 12 cm
ÜK.232

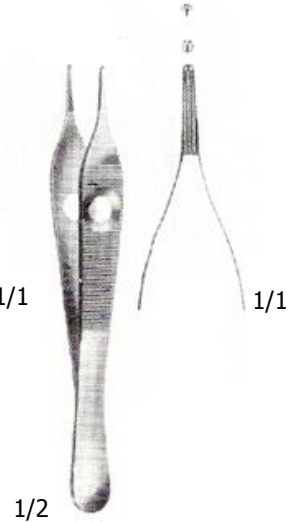

1/2
ADSON – 12 cm
ÜK.233

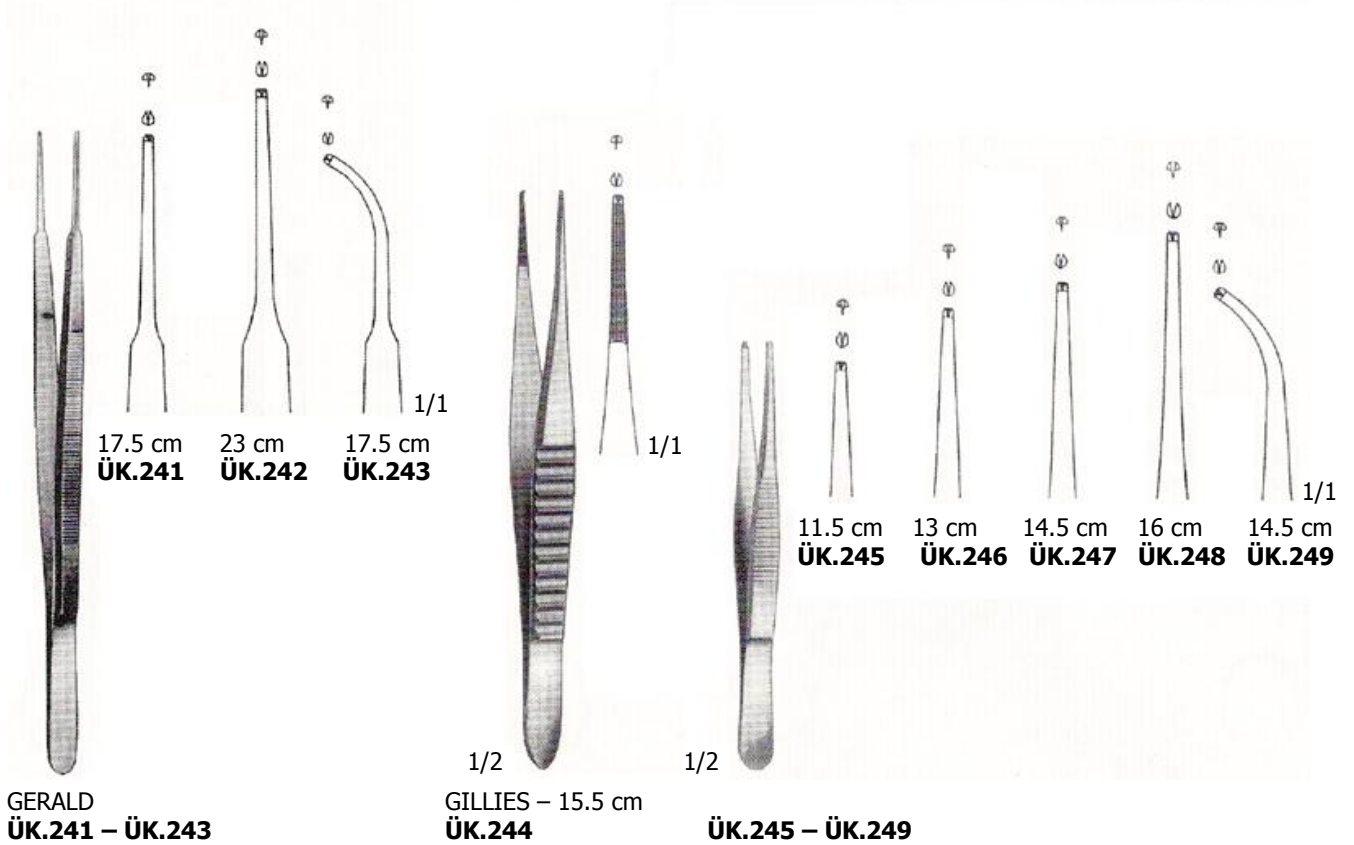
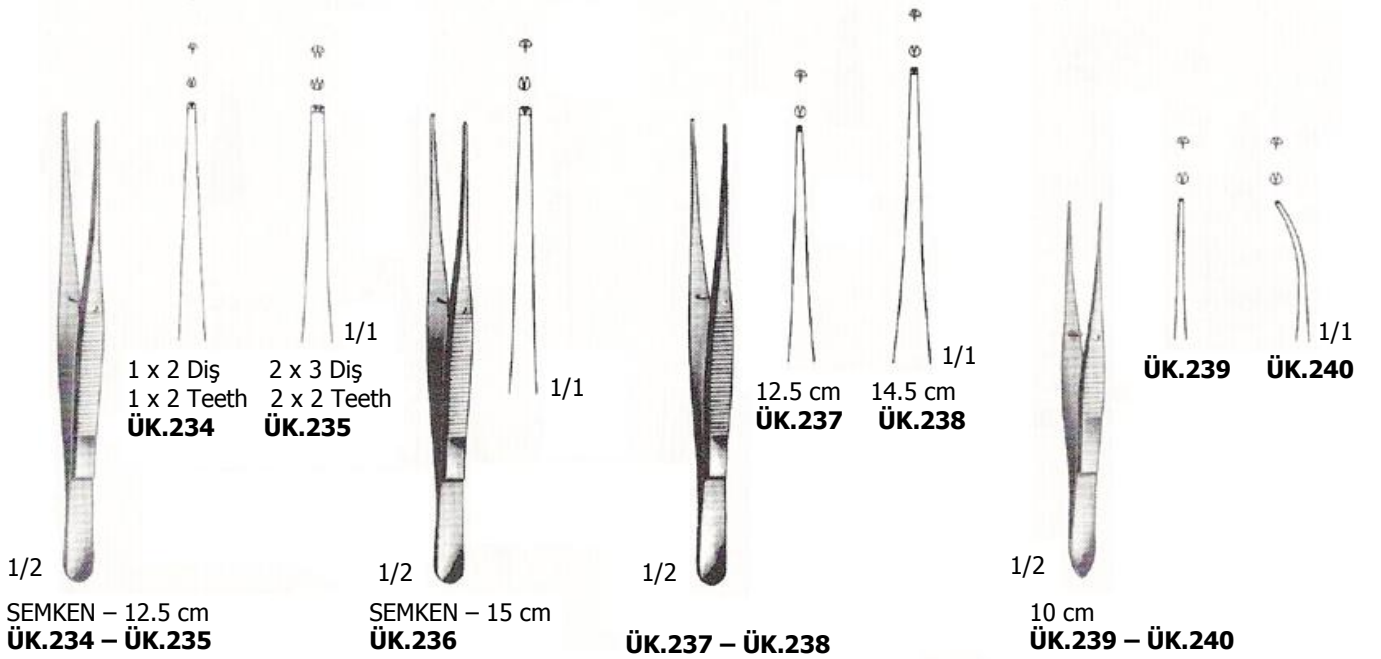

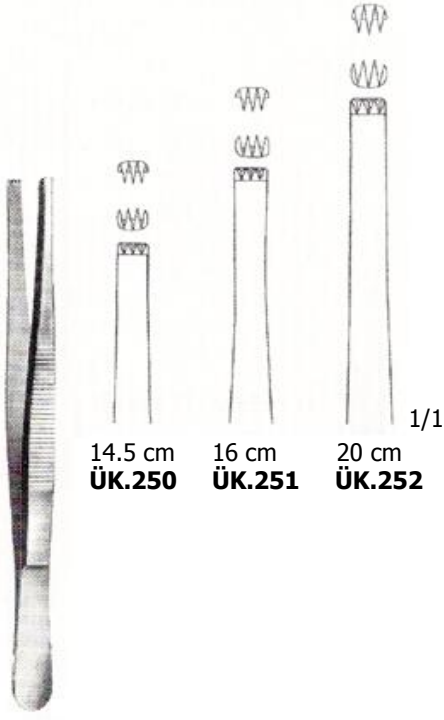

14.5 cm
ÜK.250

16 cm
ÜK.251

20 cm
ÜK.252

1/1

1/2
STANDART
3 x 4 Diş/3 x 4 Teeth
ÜK.250 – ÜK.252

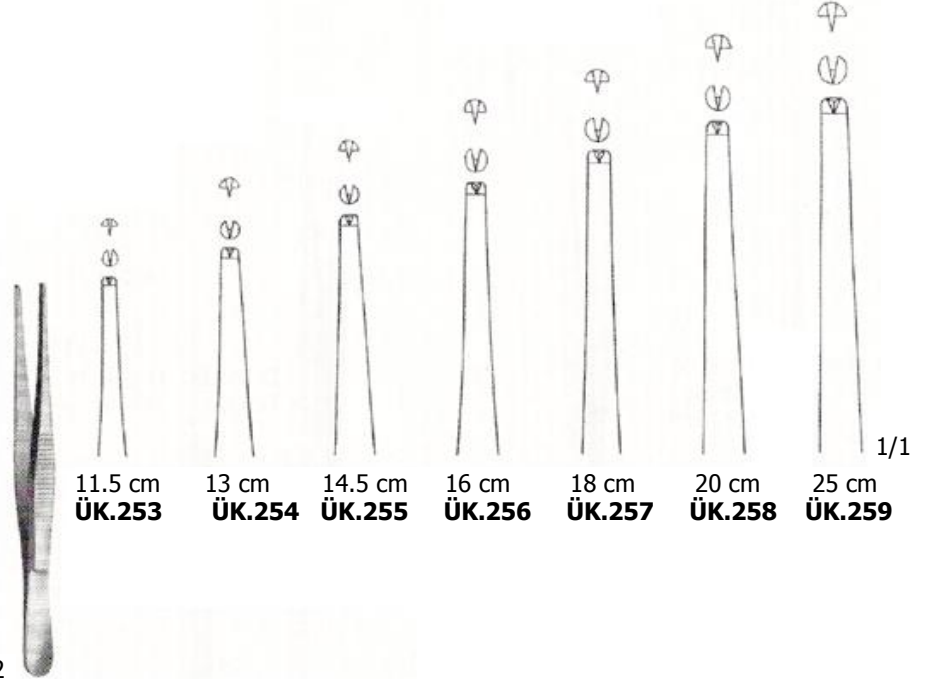

11.5 cm
ÜK.253

13 cm
ÜK.254

14.5 cm
ÜK.255

16 cm
ÜK.256

18 cm
ÜK.257

20 cm
ÜK.258

25 cm
ÜK.259

1/1

1/2
STANDART
ÜK.253 – ÜK.259

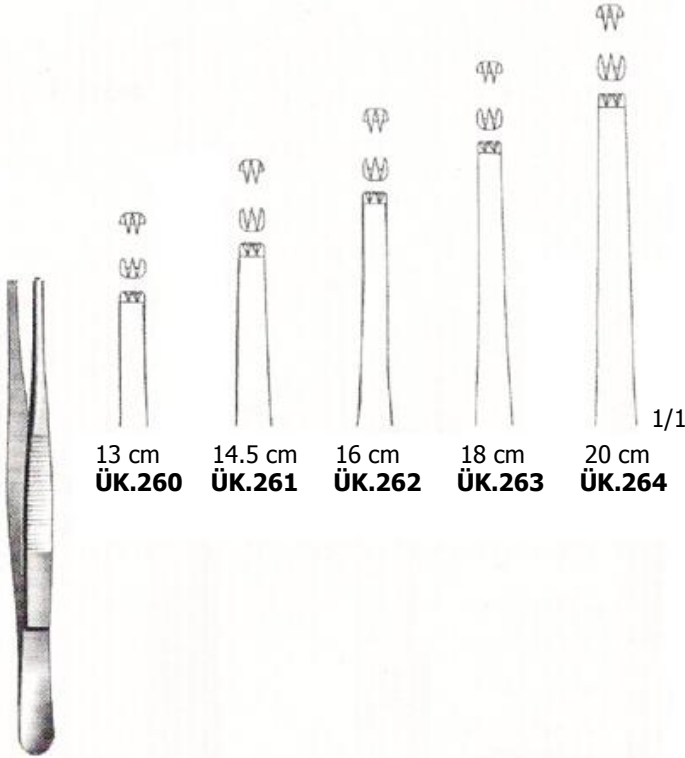

13 cm
ÜK.260

14.5 cm
ÜK.261

16 cm
ÜK.262

18 cm
ÜK.263

20 cm
ÜK.264

1/1

2 x 3 Diş/2 x 3 Teeth
ÜK.260 – ÜK.264

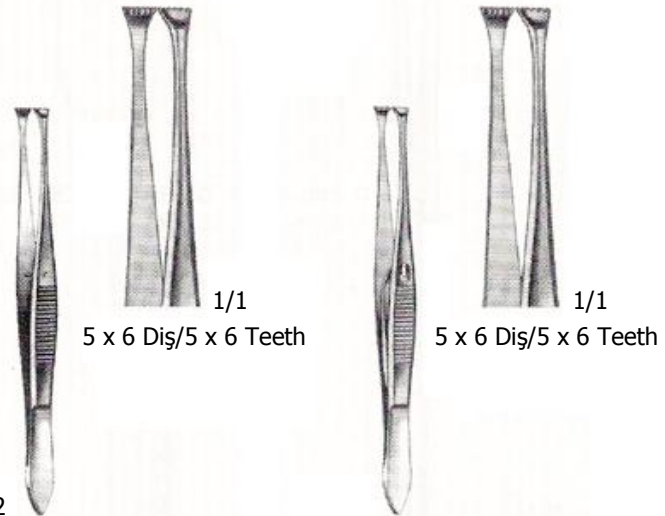

5 x 6 Diş/5 x 6 Teeth

5 x 6 Diş/5 x 6 Teeth

1/2
GRAEFE – 11 cm
ÜK.265

GRAEFE – 11 cm
Kilitli/With Catch
ÜK.266

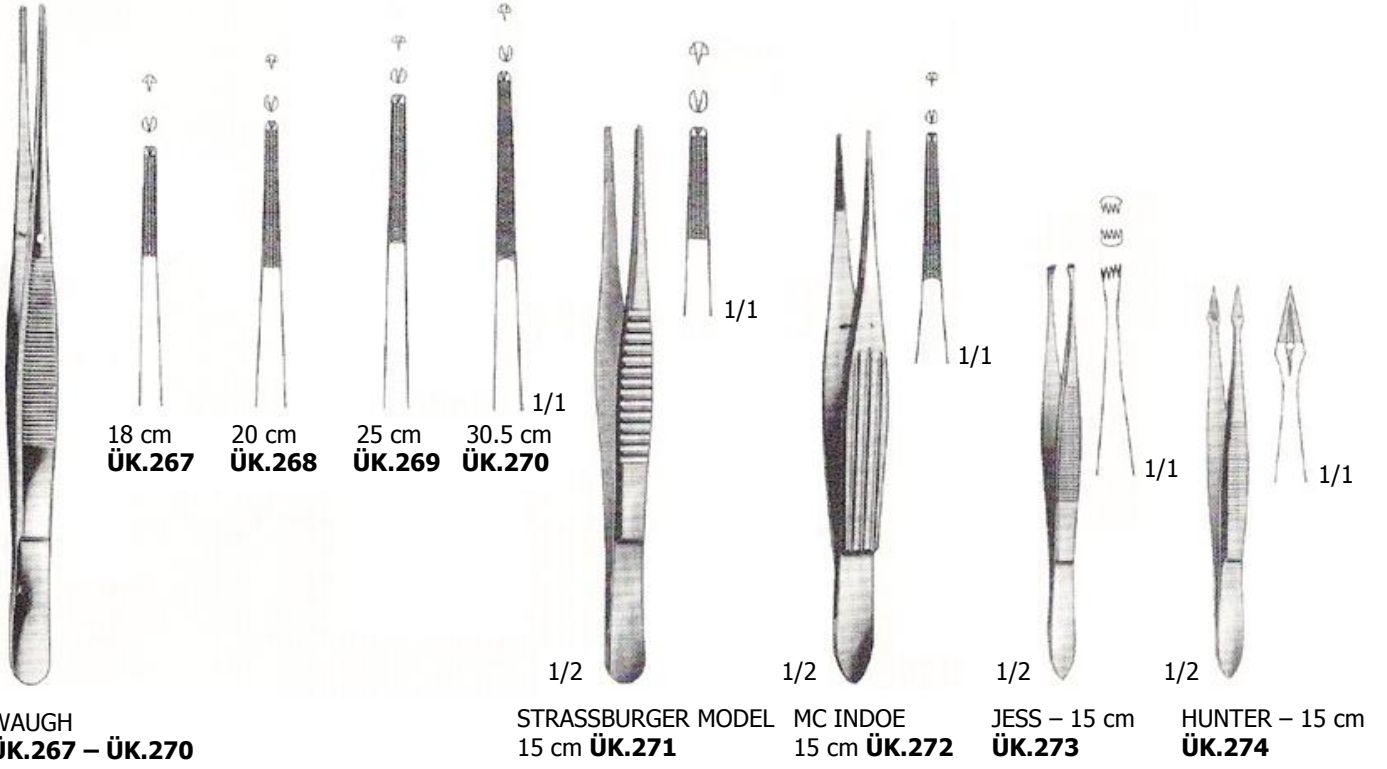

Sert Metal Ağızlı/Hard Metal Edged

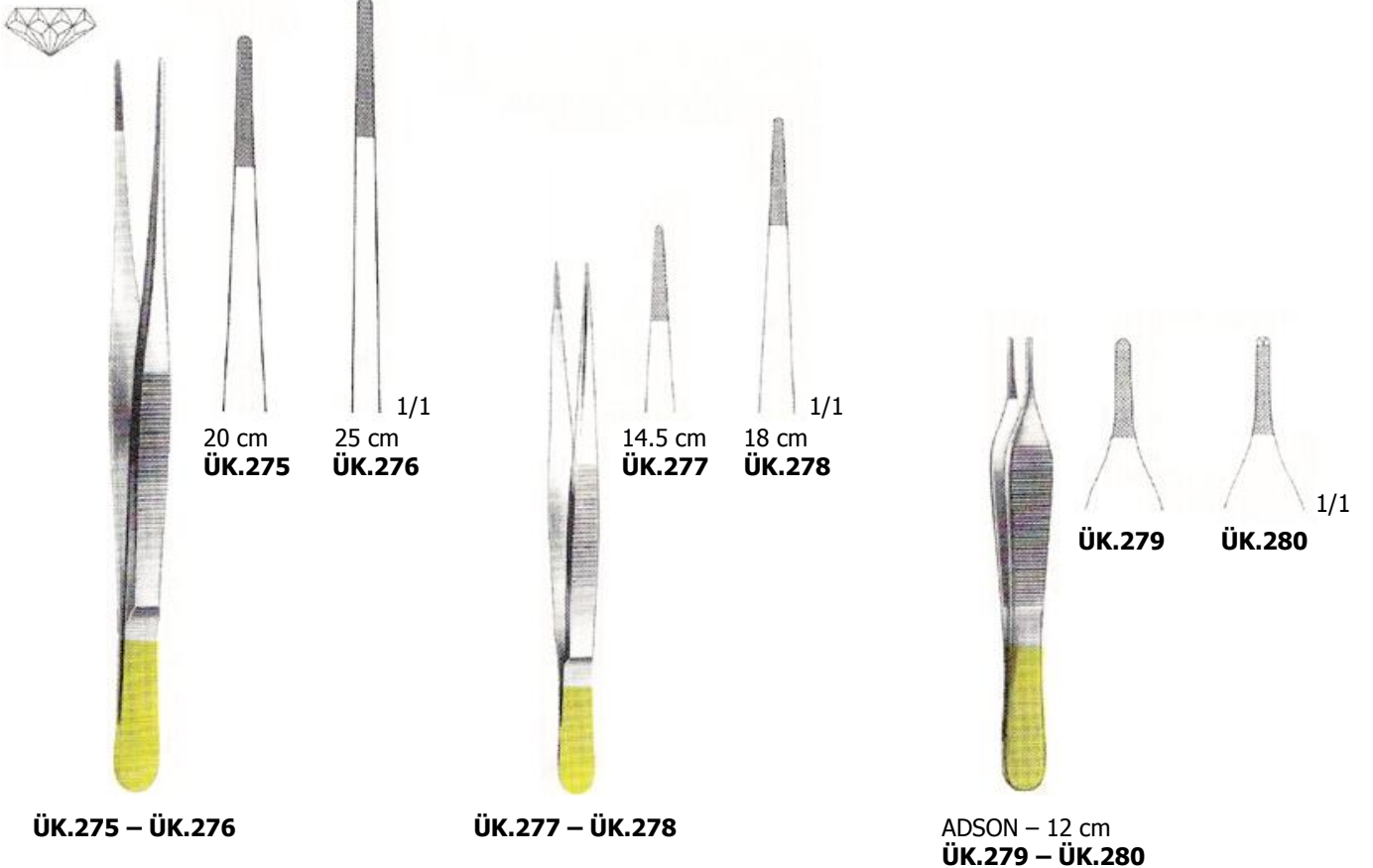

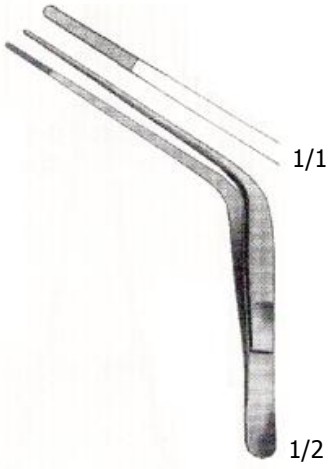

WILDE – 11.5 cm
ÜK.281



TROELTSCH – 12 cm
ÜK.282

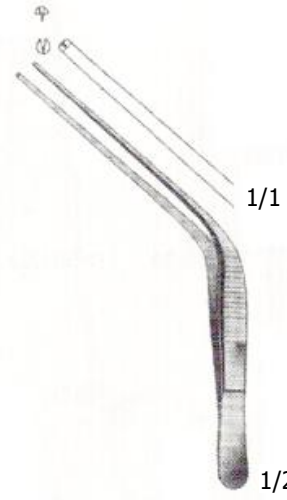

TROELTSCH – 11.5 cm
ÜK.283

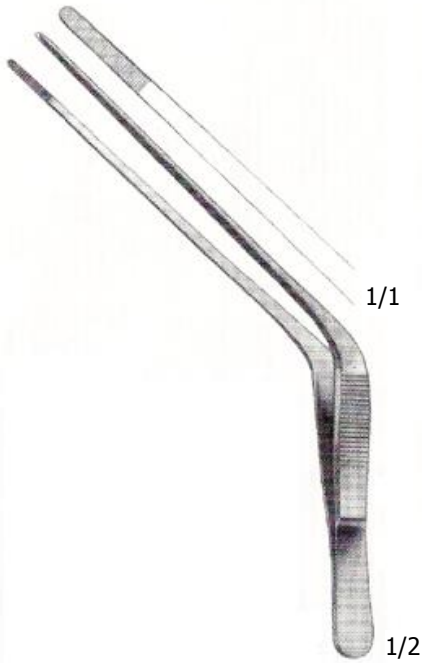

TROELTSCH – 17 cm
ÜK.284



TROELTSCH – 14 cm
ÜK.285

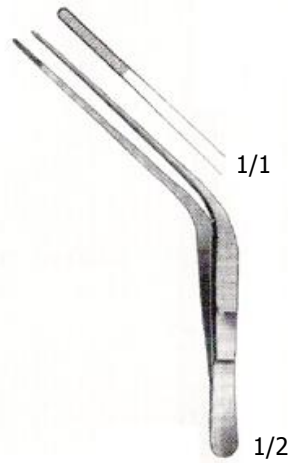

TROELTSCH – 11.5 cm
ÜK.286

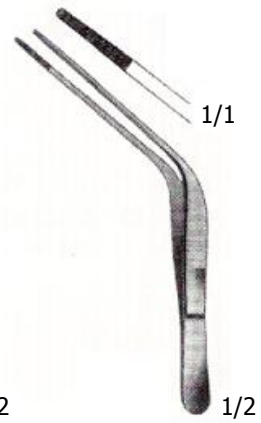

TROELTSCH – 10 cm
ÜK.287

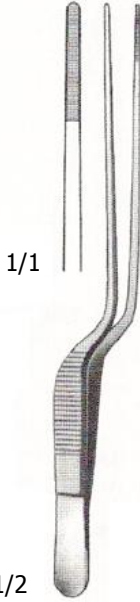

JANSEN – 16 cm
ÜK.288

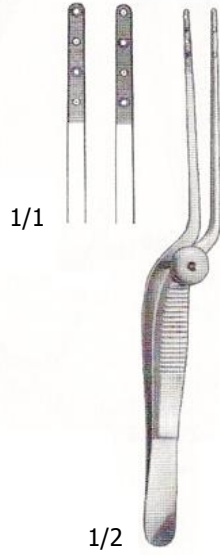

COTTLE – 14 cm
ÜK.289

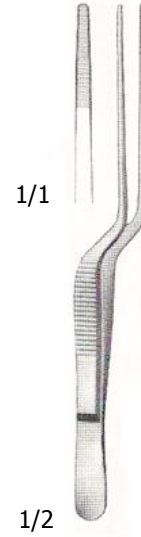

LUCAE – 11.5 cm
ÜK.290

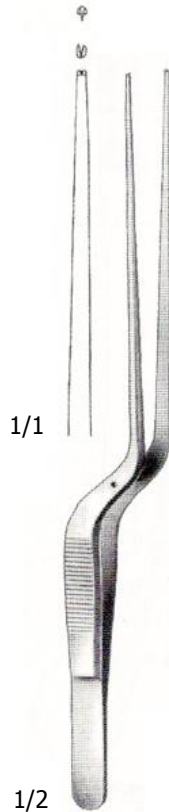

20 cm
ÜK.291

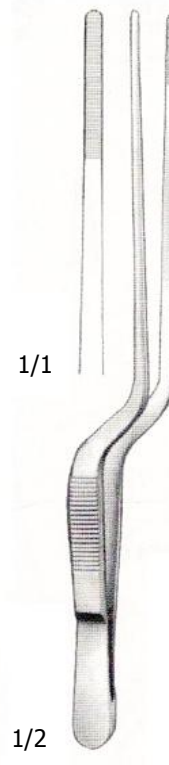

GRUENWALD – 20 cm
ÜK.292

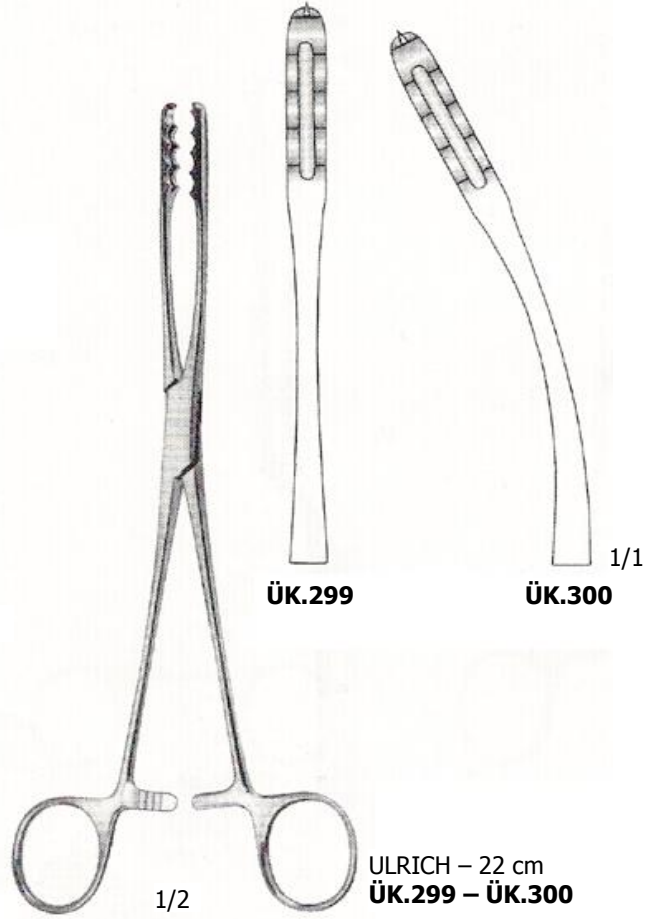
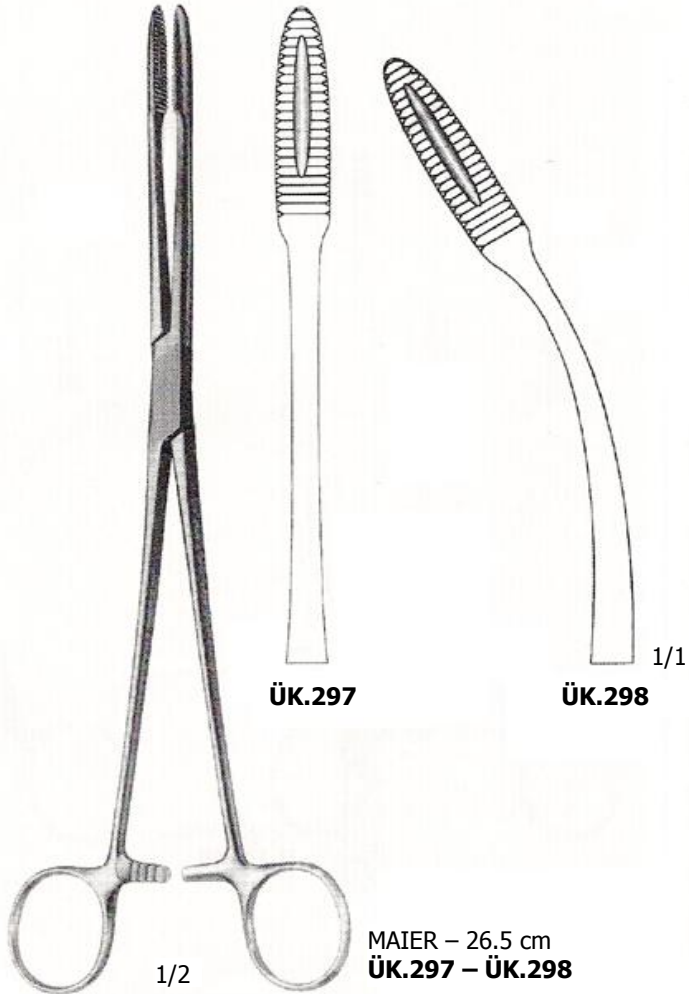
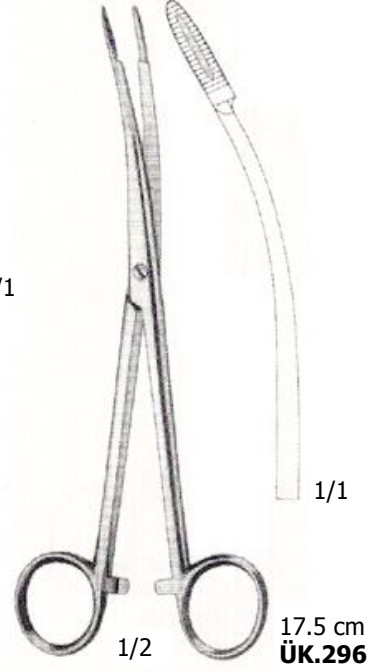
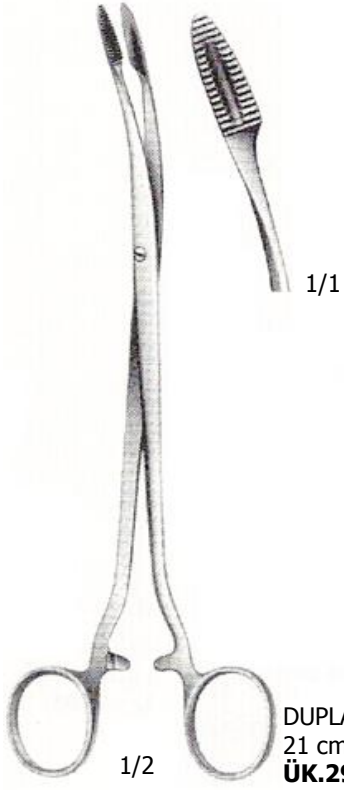



CZERNY – 20 cm
ÜK.301

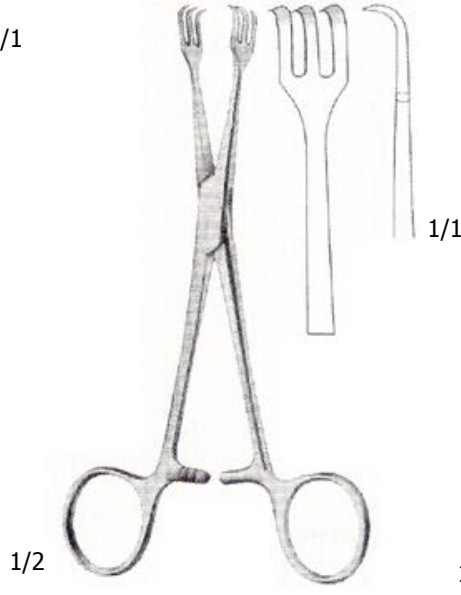

LAHEY – 15.5 cm
ÜK.302

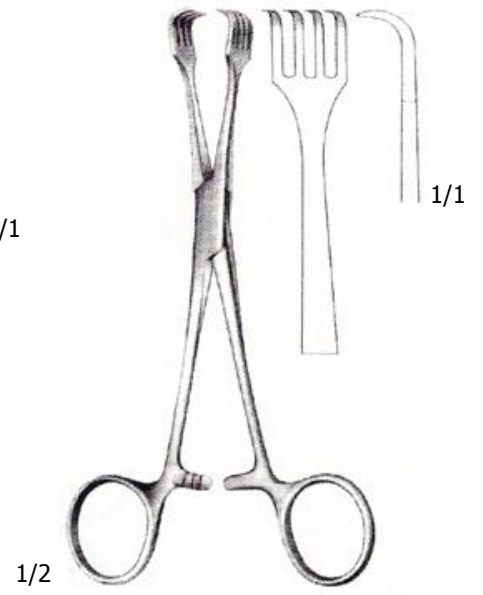

BRAUN – 15.5 cm
ÜK.303

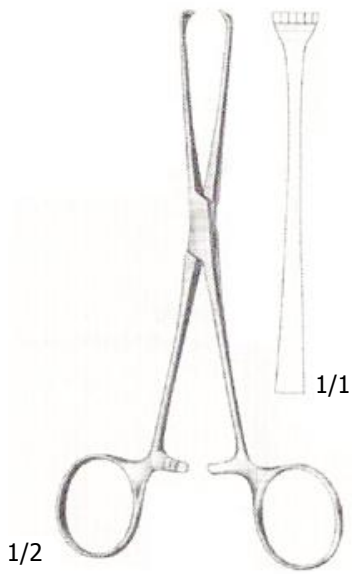

BOYS-ALLIS – 15.5 cm
5 x 6 Diş/5 x 6 Teeth
ÜK.304



ALLIS – 15.5 cm
5 x 6 Diş/5 x 6 Teeth
ÜK.305

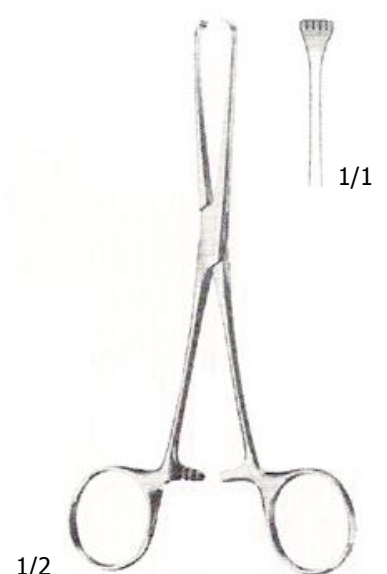

ALLIS – 15.5 cm
4 x 5 Diş/4 x 5 Teeth
ÜK.306



JAGER – 27,5 cm
Esnek Şaft/Flexible Shaft
ÜK.307



ÜK.308

ÜK.309

HERZ – 15,5 cm
ÜK.308 – ÜK.309

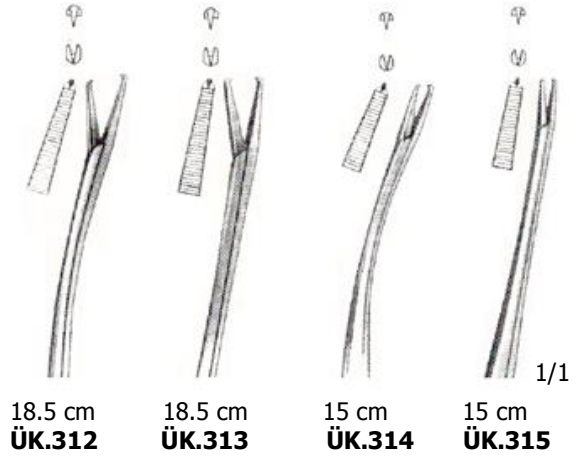

18,5 cm
ÜK.312

18,5 cm
ÜK.313

15 cm
ÜK.314

15 cm
ÜK.315

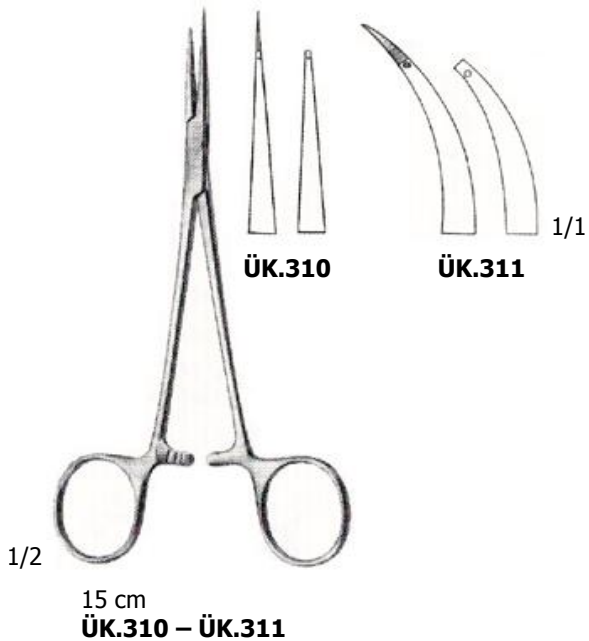

ÜK.310

ÜK.311

15 cm
ÜK.310 – ÜK.311



BRAND
ÜK.312 – ÜK.315

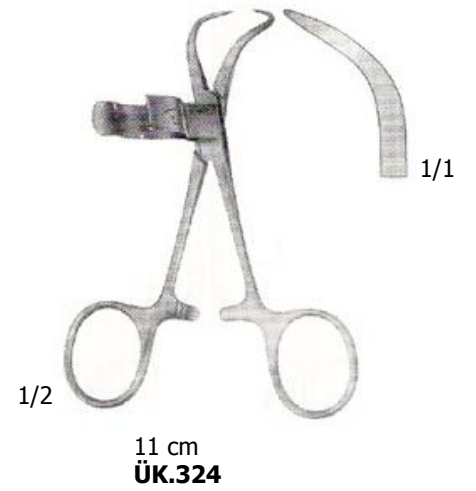
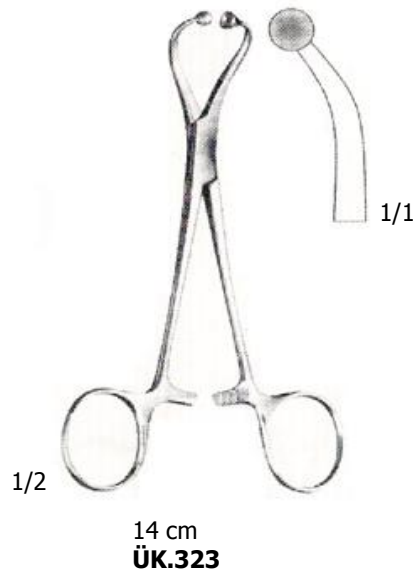
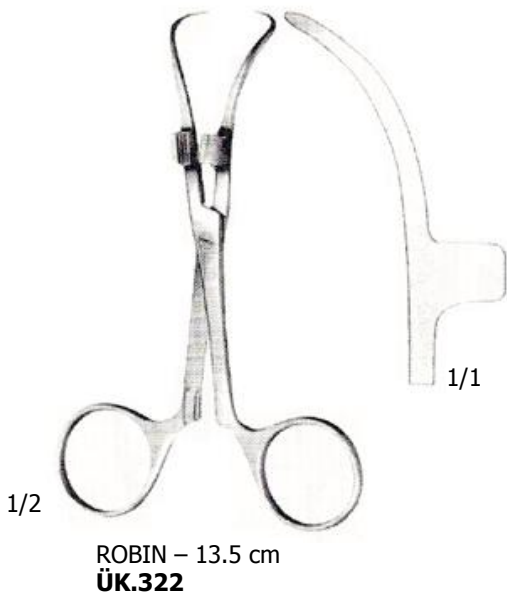
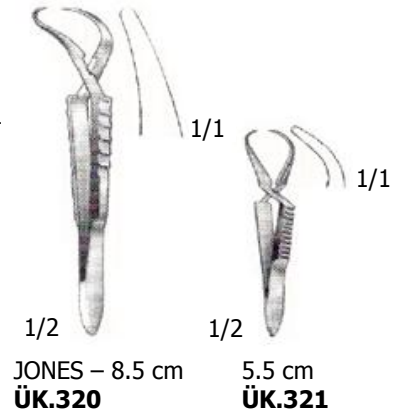
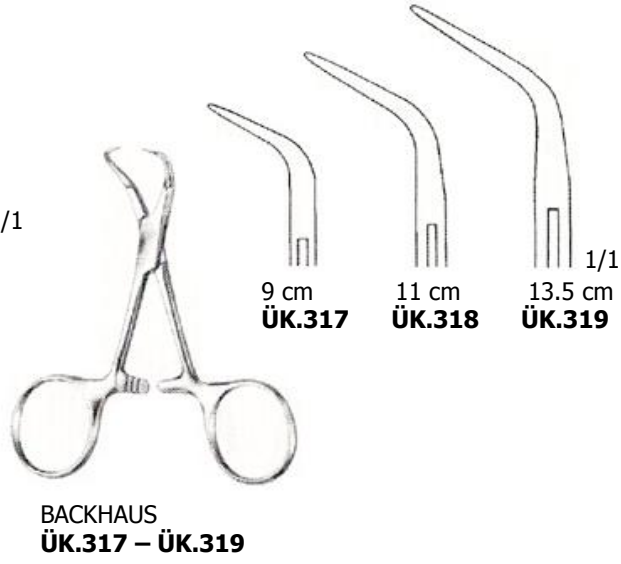
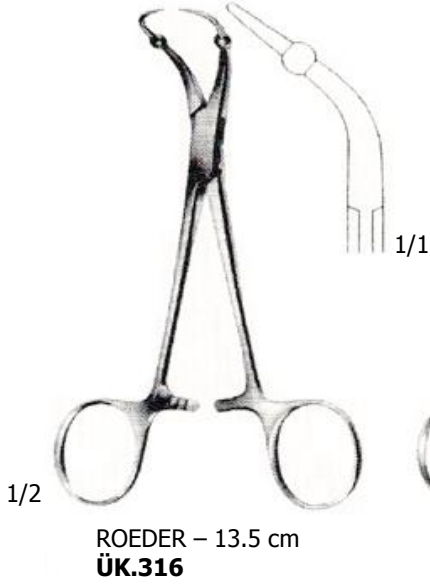



Kilitsiz
Without Catch
ÜK.325



1/1
Kilitli
With Catch
ÜK.326

1/2
JACOBSON – 18.5 cm
ÜK.325 – ÜK.326



ÜK.327



1/1
ÜK.328

1/2
16 cm
Kilitsiz/Without Catch
ÜK.327 – ÜK.328



ÜK.329



1/1
ÜK.330

1/2
CASTROVIEJO – 16 cm
Kilitli/With Catch
ÜK.329 – ÜK.330



11.5 cm
ÜK.331



13.5 cm
ÜK.332

1/2
BARRAQUER
Kilitsiz/Without Catch
ÜK.331 – ÜK.332



ÜK.333



1/1
ÜK.334

1/2
BARRAQUER – 15 cm
Kilitsiz/Without Catch
ÜK.333 – ÜK.334



ÜK.335



1/1
ÜK.336

1/2
15 cm
Kilitli/With Catch
ÜK.335 – ÜK.336



ÜK.337



1/1
ÜK.338

1/2
BARRAQUER – 12 cm
Kilitli/With Catch
ÜK.337 – ÜK.338



ÜK.339



1/1
ÜK.340

1/2
BARRAQUER – 12 cm
Kilitsiz/Without Catch
ÜK.339 – ÜK.340

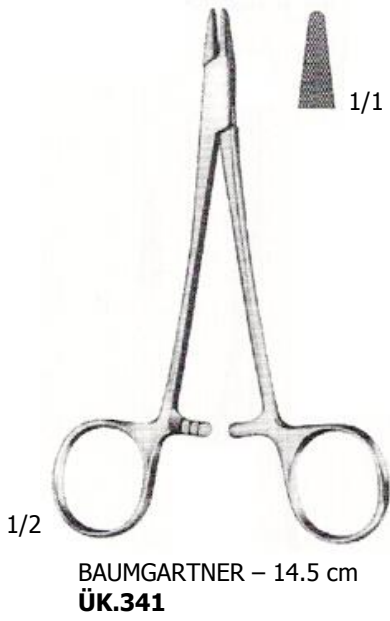

Sert Metal Ağızlı/Hard Metal Edged

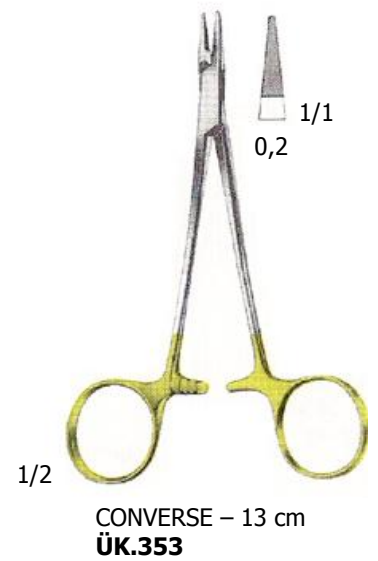
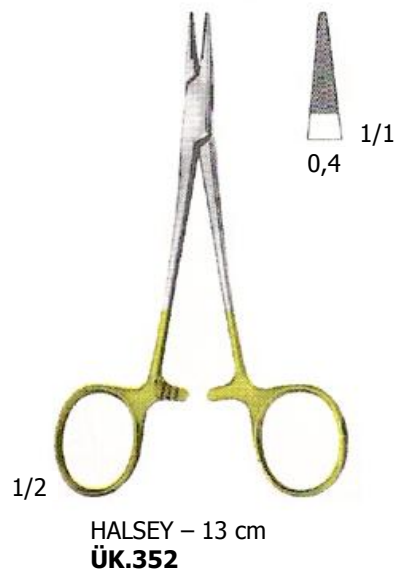
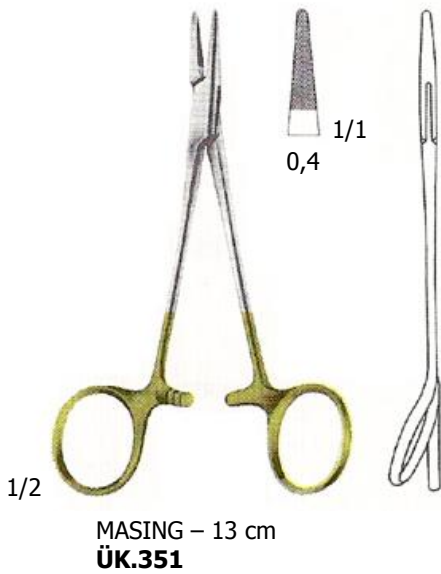
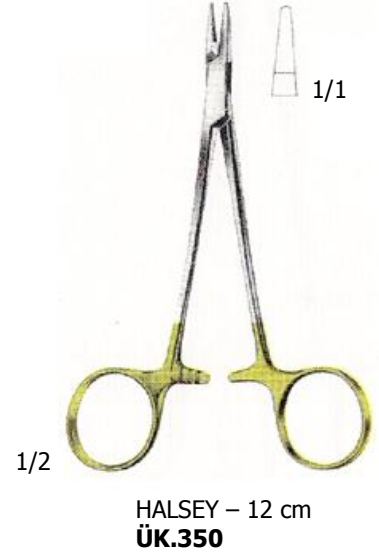

Sert Metal Ağızlı/Hard Metal Edged



DE BAKEY – 15 cm
ÜK.354 – ÜK.357

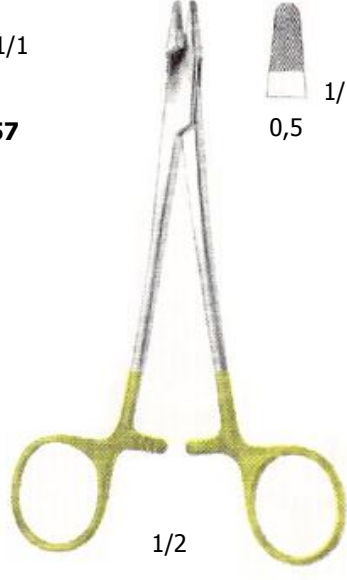
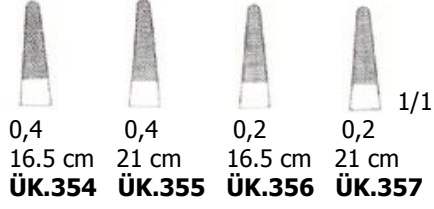

1/2
15 cm
ÜK.358

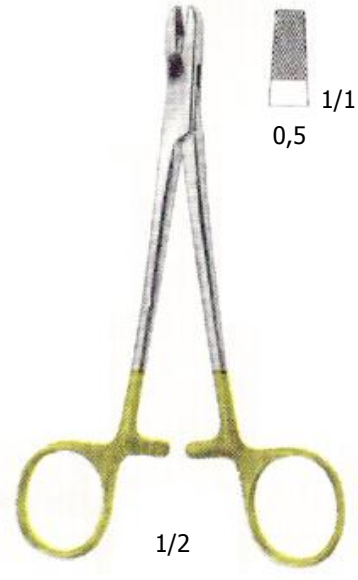

1/2
15 cm
ÜK.359

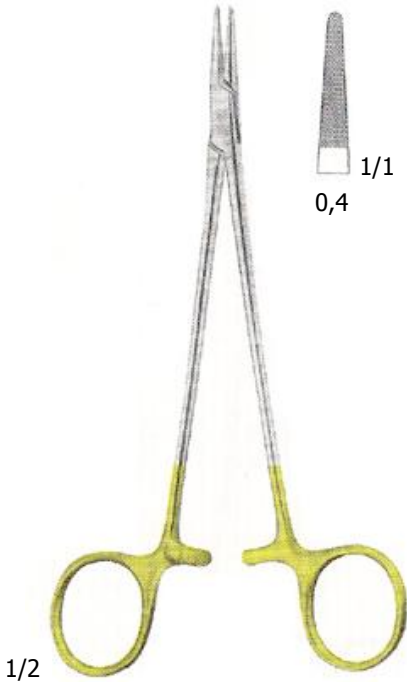

1/2
DE BAKEY – 18 cm
ÜK.360



1/2
SAROT – 17.5 cm
ÜK.361

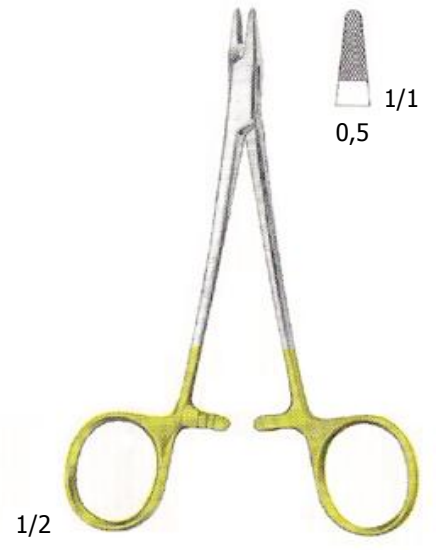

1/2
BAUMGARTNER – 14.5 cm
ÜK.362



Sert Metal Ağızlı/Hard Metal Edged



**RYDER
ÜK.363 – ÜK.365**



**RYDER
ÜK.366 – ÜK.369**

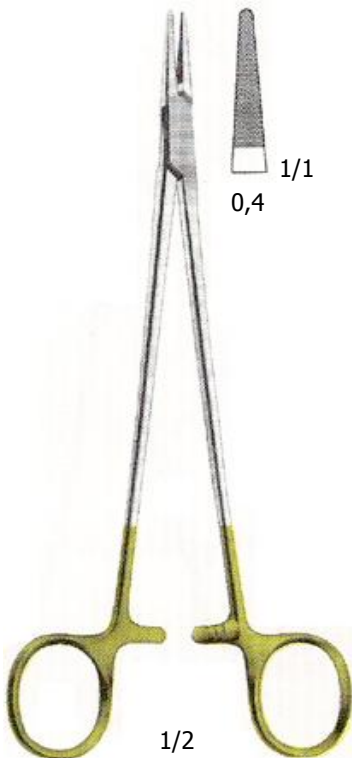

**HEGAR-MAYO-SEELEY – 20 cm
ÜK.370**

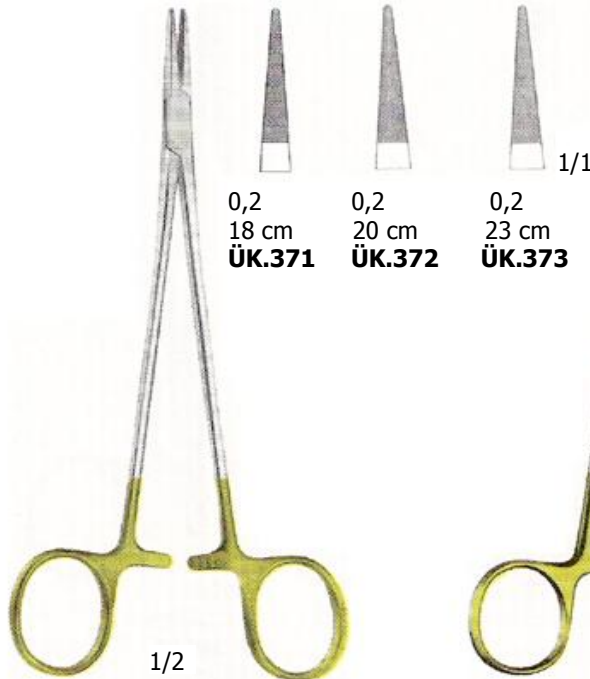

ÜK.371 – ÜK.373

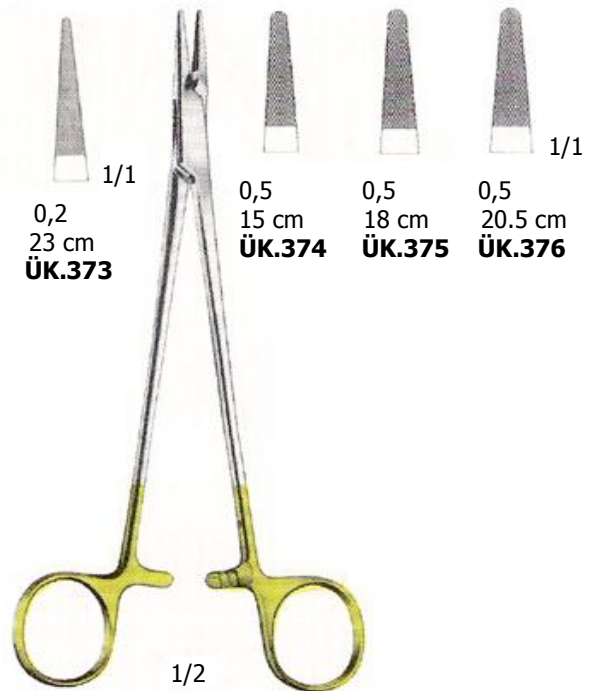

**HEGAR-MAYO
ÜK.374 – ÜK.376**



LICHTENBERG – 19.5 cm
ÜK.377



LAHGENBECK
ÜK.378 – ÜK.379

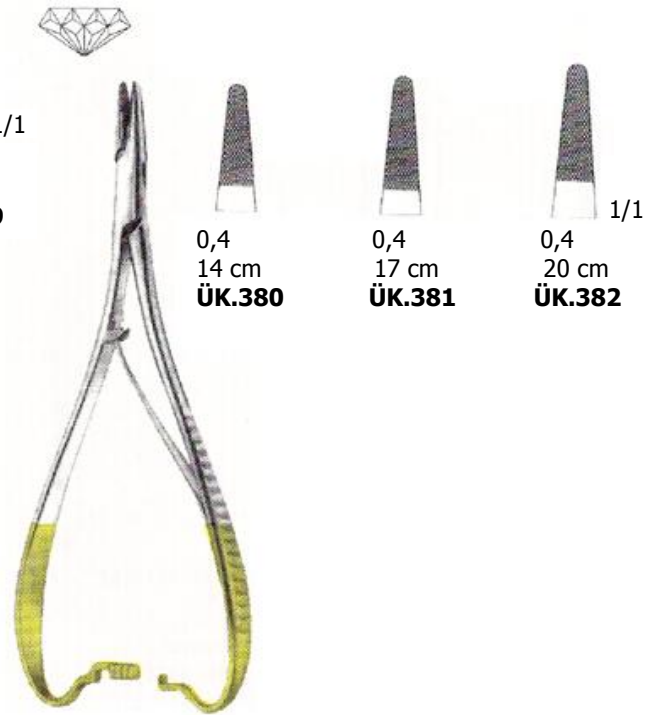

MATHIEU-STANDART
ÜK.380 – ÜK.382

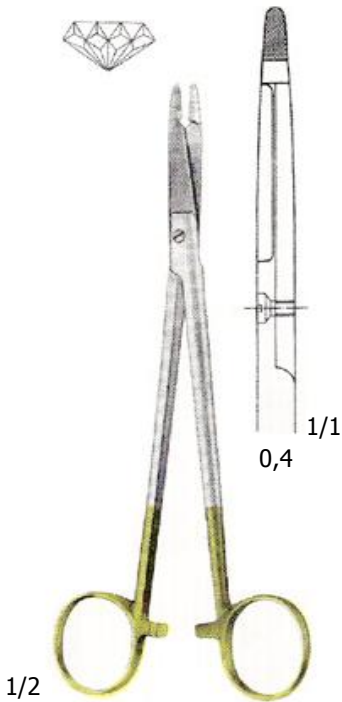

HEGAR-OLSEN – 16.5 cm
ÜK.383

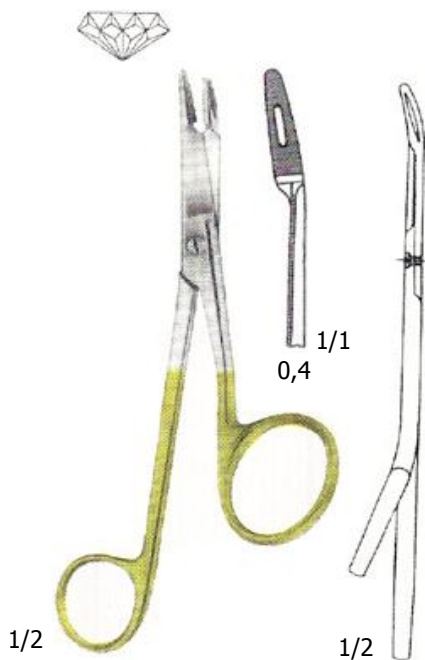

GILLIES – 16 cm
Tırtıllı/Serrated
ÜK.384

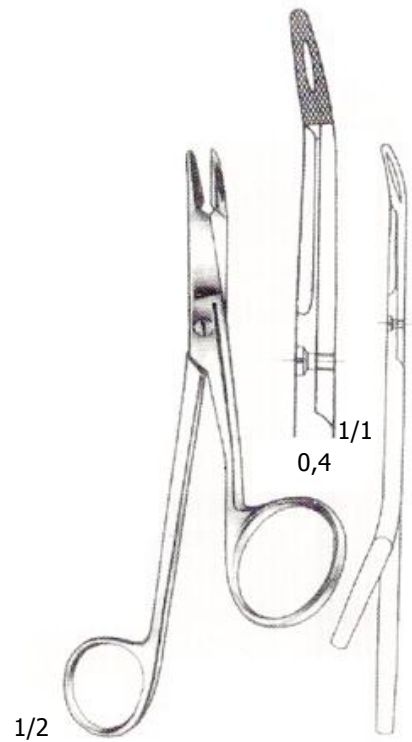

GILLIES – 16 cm
ÜK.385

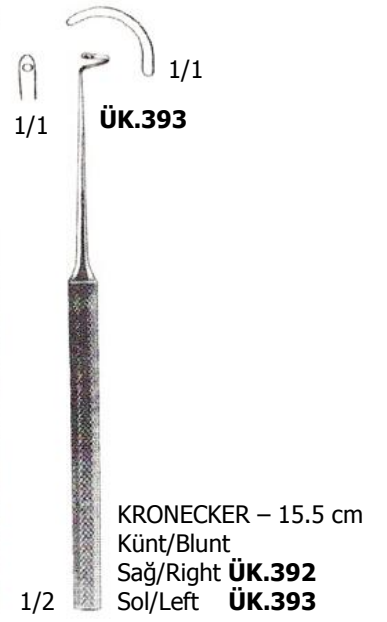

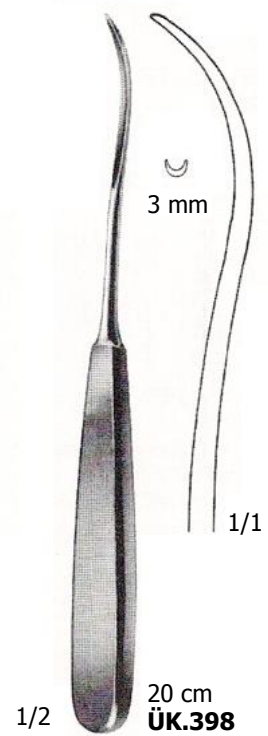
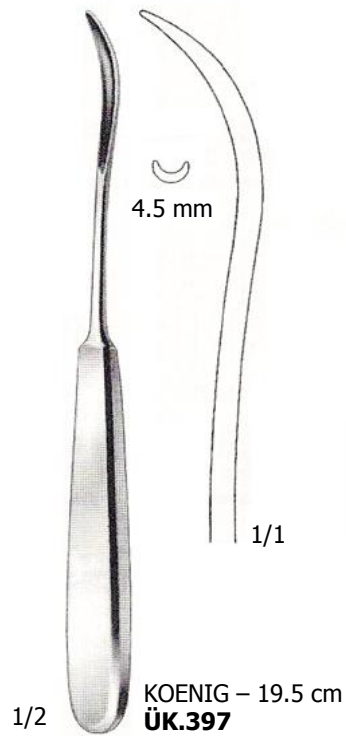
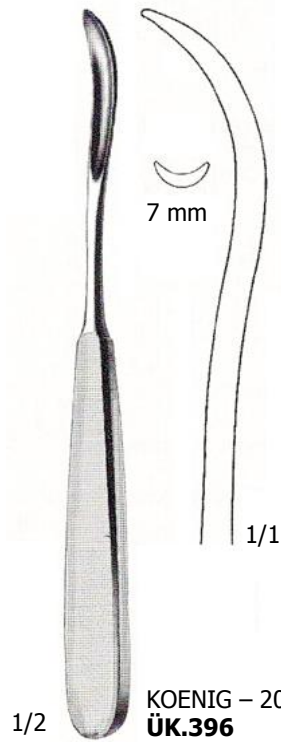
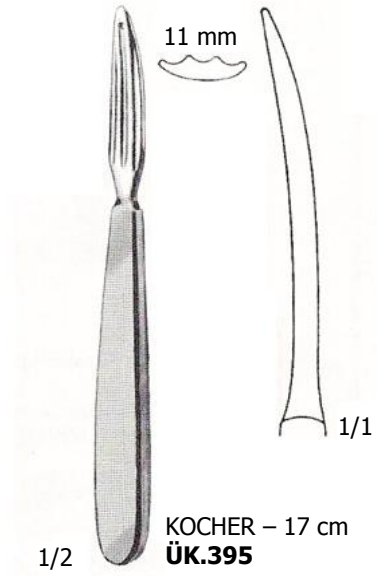
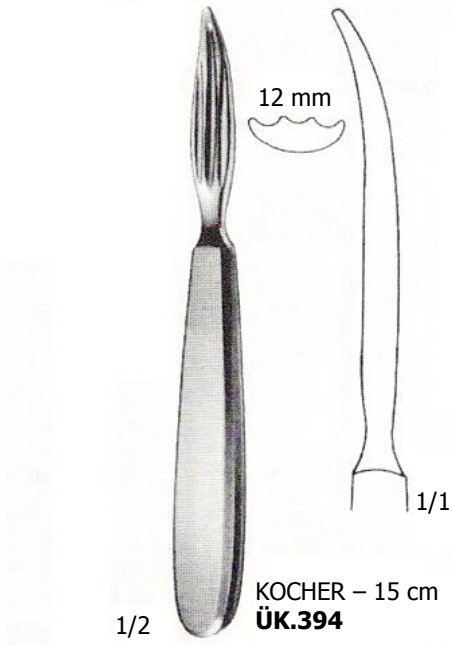

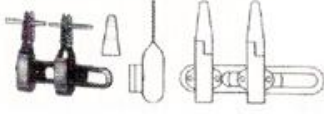

BIEMER-MULLER
Çene Uzunluğu/Lenght of Jaws. 6 mm
Açıklık/Opening 4 mm
Kapanma Kuvveti/Closing Force 30-40 gr.
ÜK.399



BIEMER-MULLER
Çene Uzunluğu/Lenght of Jaws. 4.5 mm
Açıklık/Opening 3 mm
Kapanma Kuvveti/Closing Force 25-30 gr.
ÜK.400

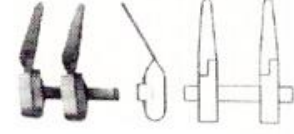

BIEMER-MULLER
Çene Uzunluğu/Lenght of Jaws. 9 mm
Açıklık/Opening 5 mm
Kapanma Kuvveti/Closing Force 25-30 gr.
ÜK.401

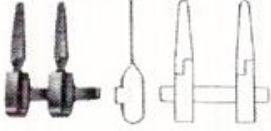

BIEMER-MULLER
Çene Uzunluğu/Lenght of Jaws. 9 mm
Açıklık/Opening 5 mm
Kapanma Kuvveti/Closing Force 25-30 gr.
ÜK.402

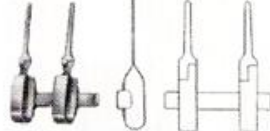

BIEMER-MULLER
Çene Uzunluğu/Lenght of Jaws. 9 mm
Açıklık/Opening 5 mm
Kapanma Kuvveti/Closing Force 25-30 gr.
ÜK.403

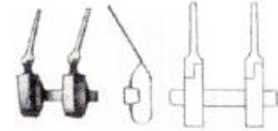

BIEMER-MULLER
Çene Uzunluğu/Lenght of Jaws. 9 mm
Açıklık/Opening 5 mm
Kapanma Kuvveti/Closing Force 25-30 gr.
ÜK.404

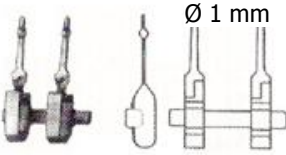

MULLER
Kapanma Kuvveti/Closing Force 25-30 gr.
ÜK.405

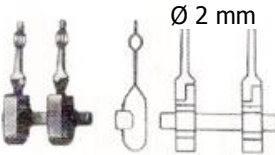

MULLER
Kapanma Kuvveti/Closing Force 25-30 gr.
ÜK.406



Aproksimatör/Approximator
ÜK.409

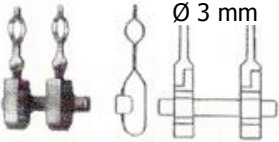

MULLER
Kapanma Kuvveti/Closing Force 25-30 gr.
ÜK.407

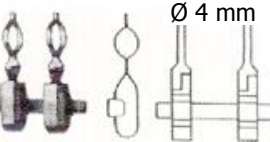

MULLER
Kapanma Kuvveti/Closing Force 25-30 gr.
ÜK.408



1/2

BIEMER – 14.5 cm
Aproksimatör/Approximator
ÜK.410

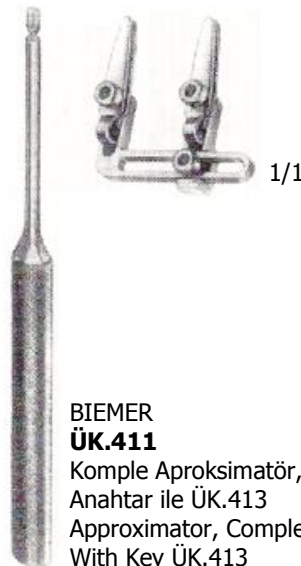

1/1

BIEMER
ÜK.411
Komple Aproksimatör,
Anahtar ile ÜK.413
Approximator, Complete
With Key ÜK.413



1/1

BIEMER
ÜK.412
Komple Aproksimatör,
Anahtar ile ÜK.413
Approximator, Complete
With Key ÜK.413

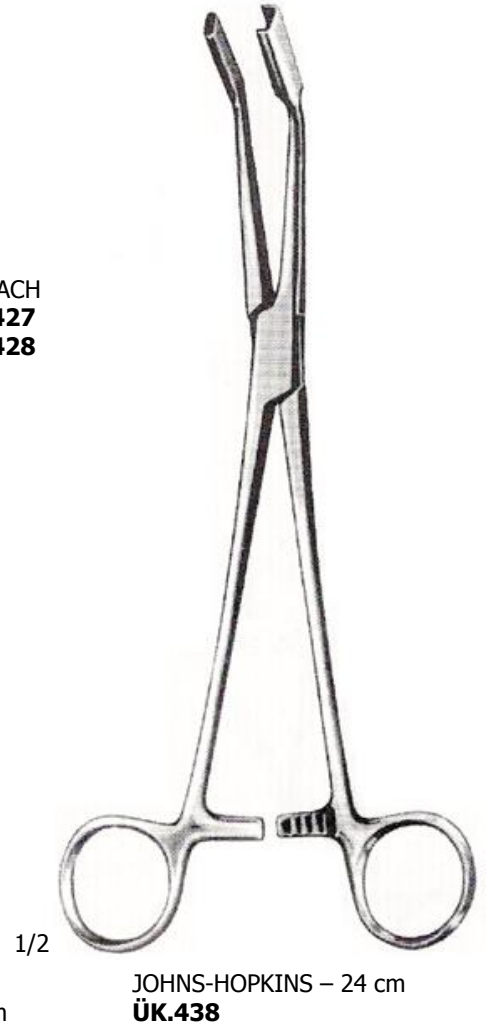

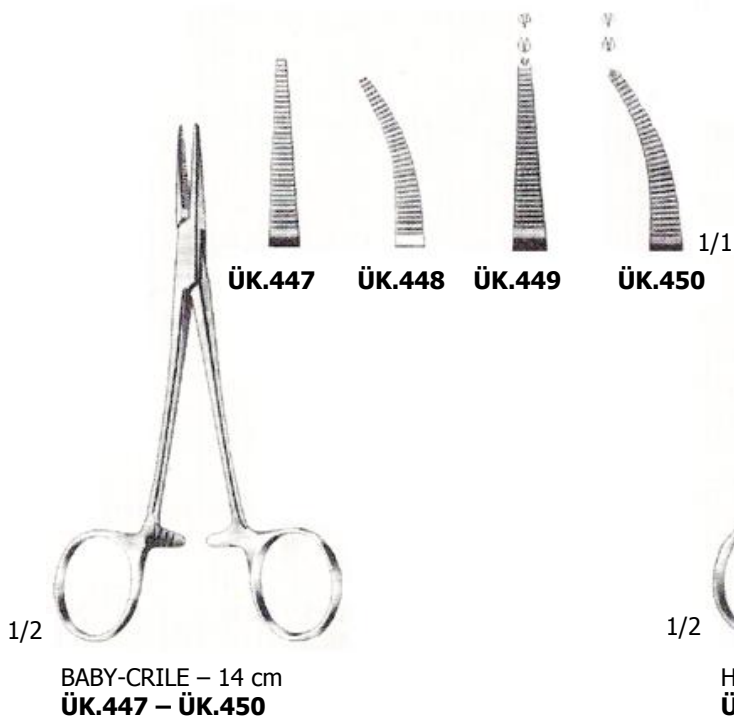
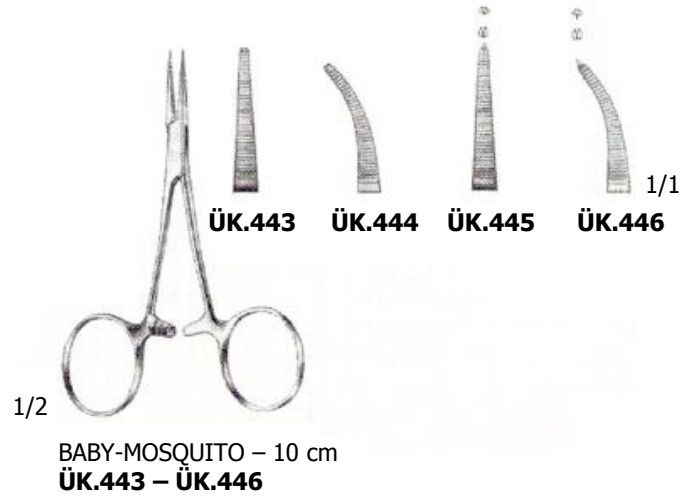

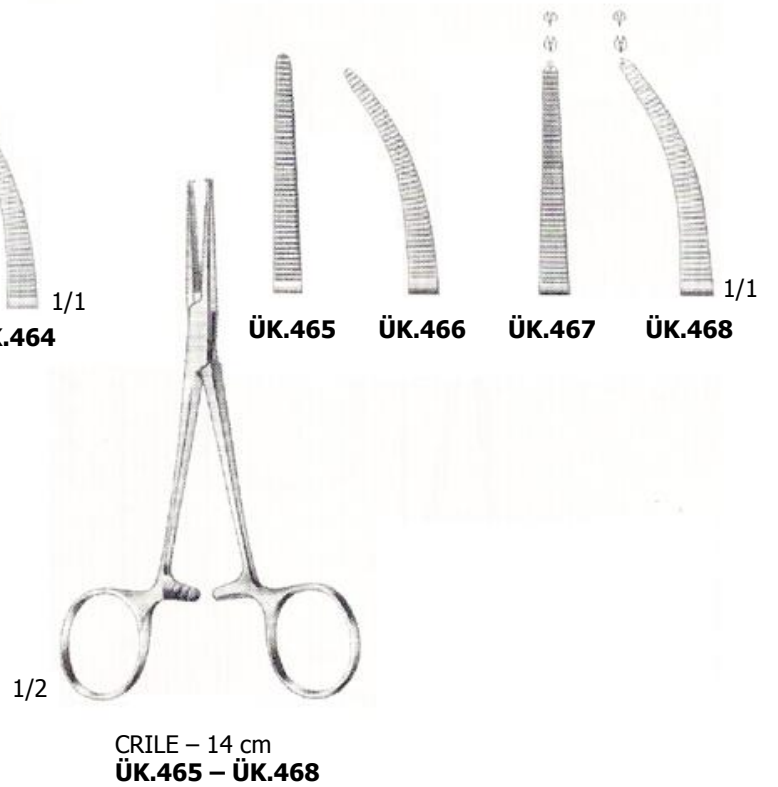
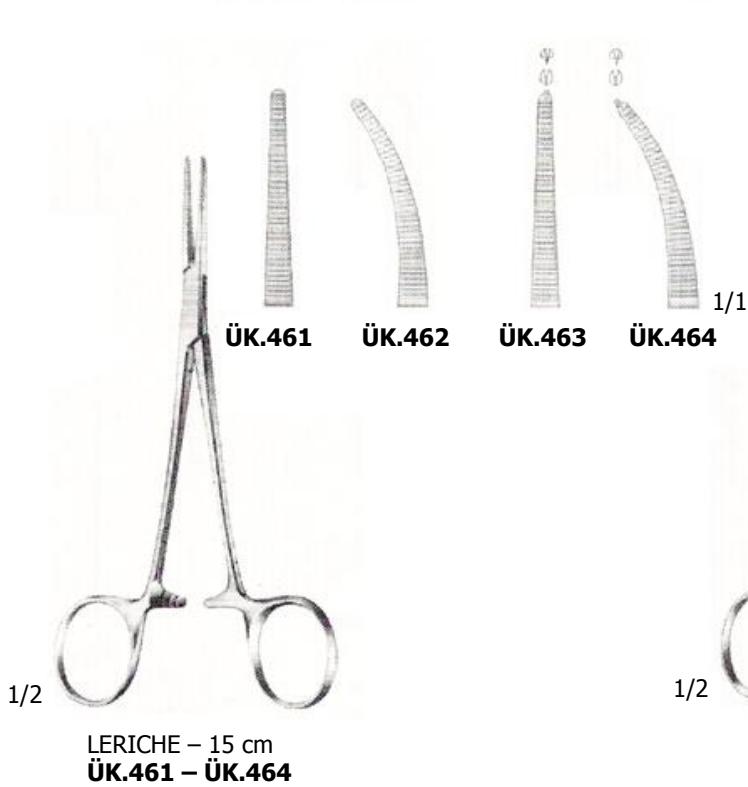

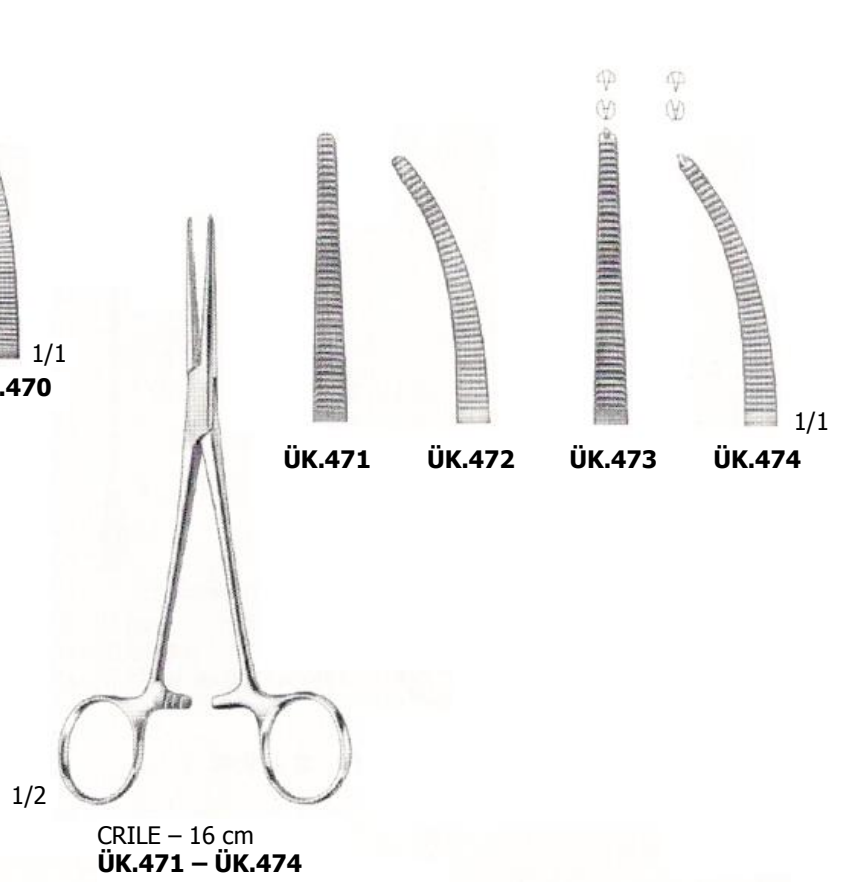



ROCHESTER-PEAN – 16 cm
ÜK.479 – ÜK.480

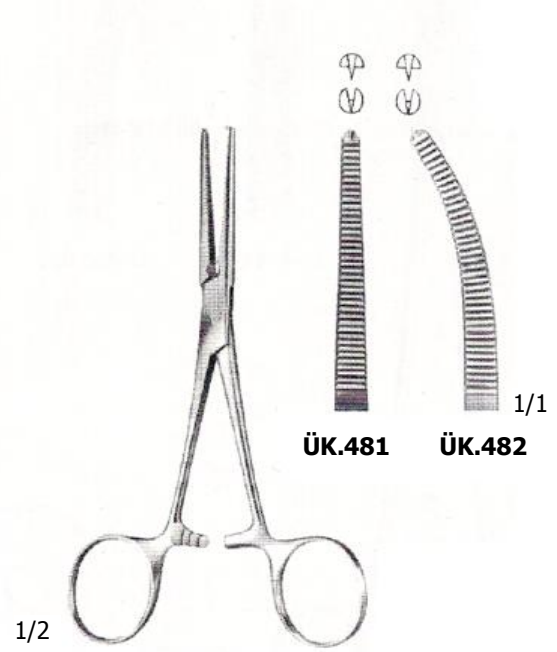

ROCHESTER-OGHSNER – 14 cm
ÜK.481 – ÜK.482

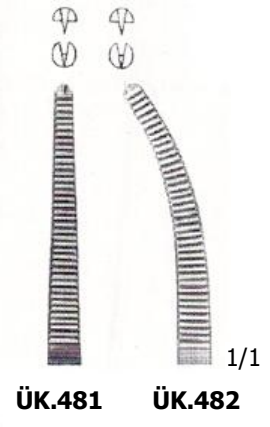

PEAN
ÜK.483 – ÜK.486

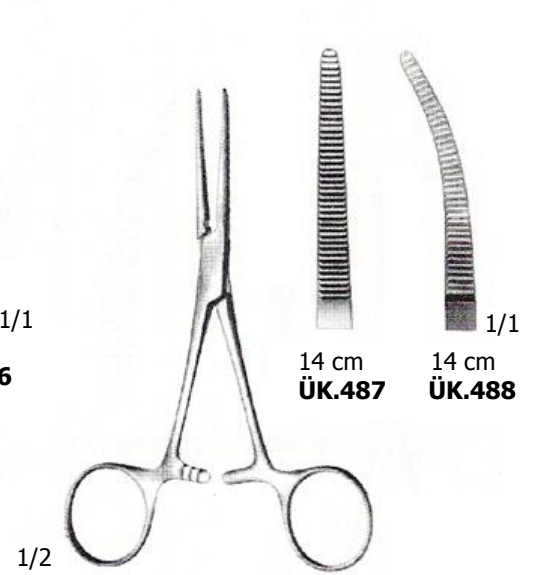
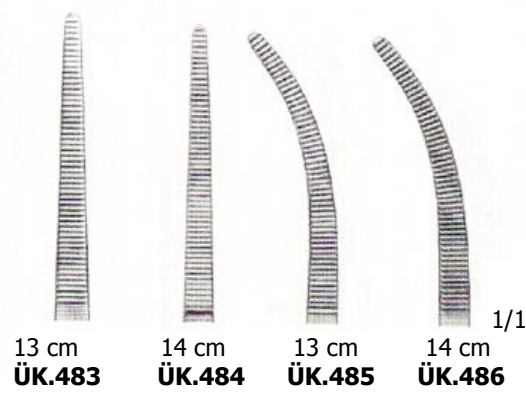

PEAN
ÜK.487 – ÜK.488

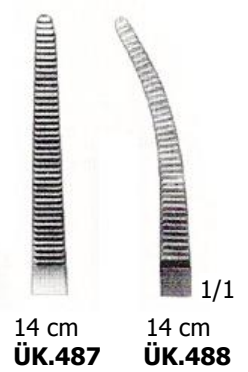

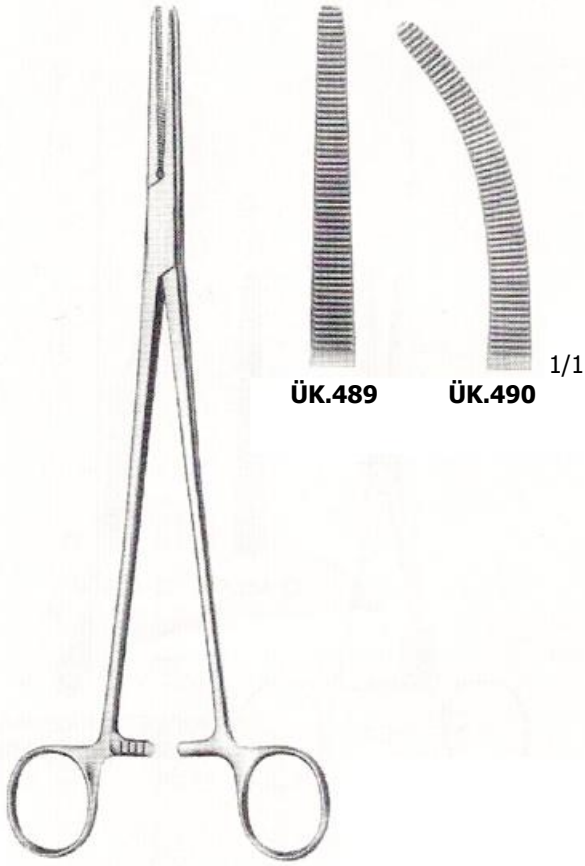

ROBERTS – 25 cm
ÜK.489 – ÜK.490

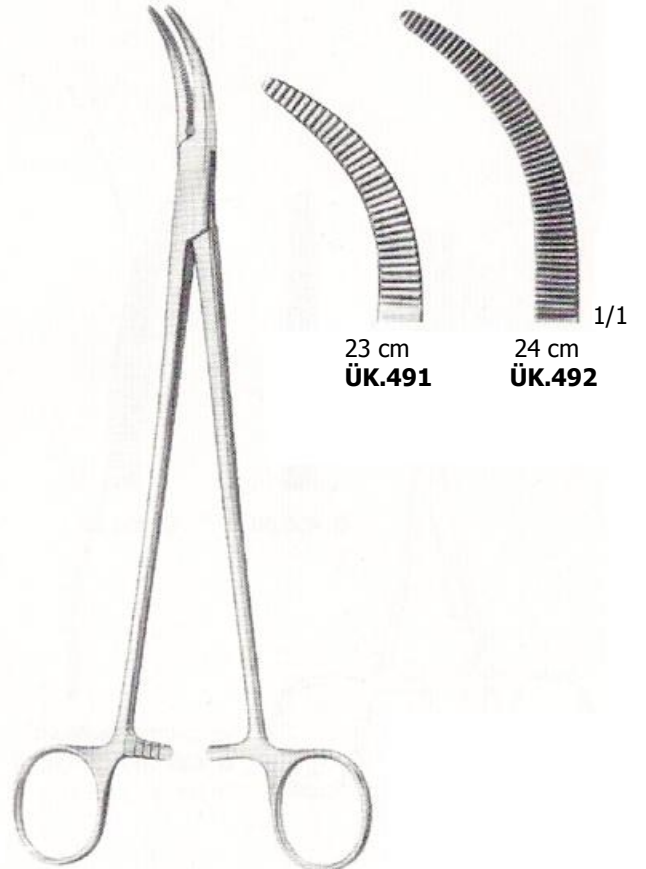

MOYNIHAN
ÜK.491 – ÜK.492

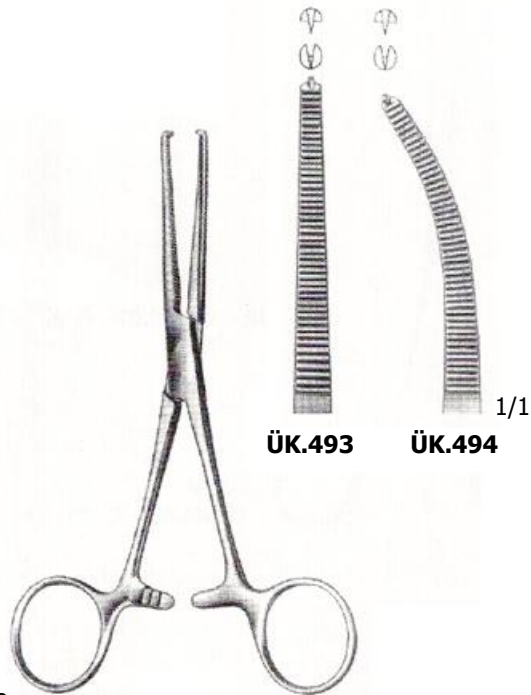

KOCHER – 15 cm
ÜK.493 – ÜK.494

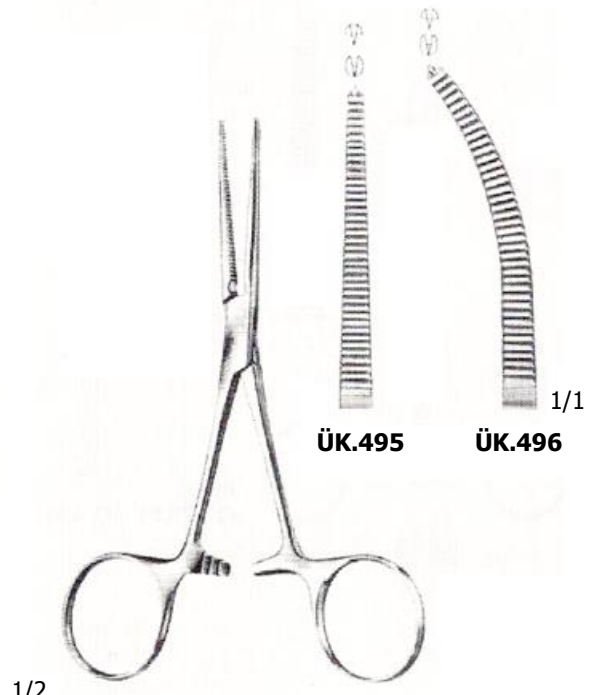

KOCHER – 14 cm
ÜK.495 – ÜK.496

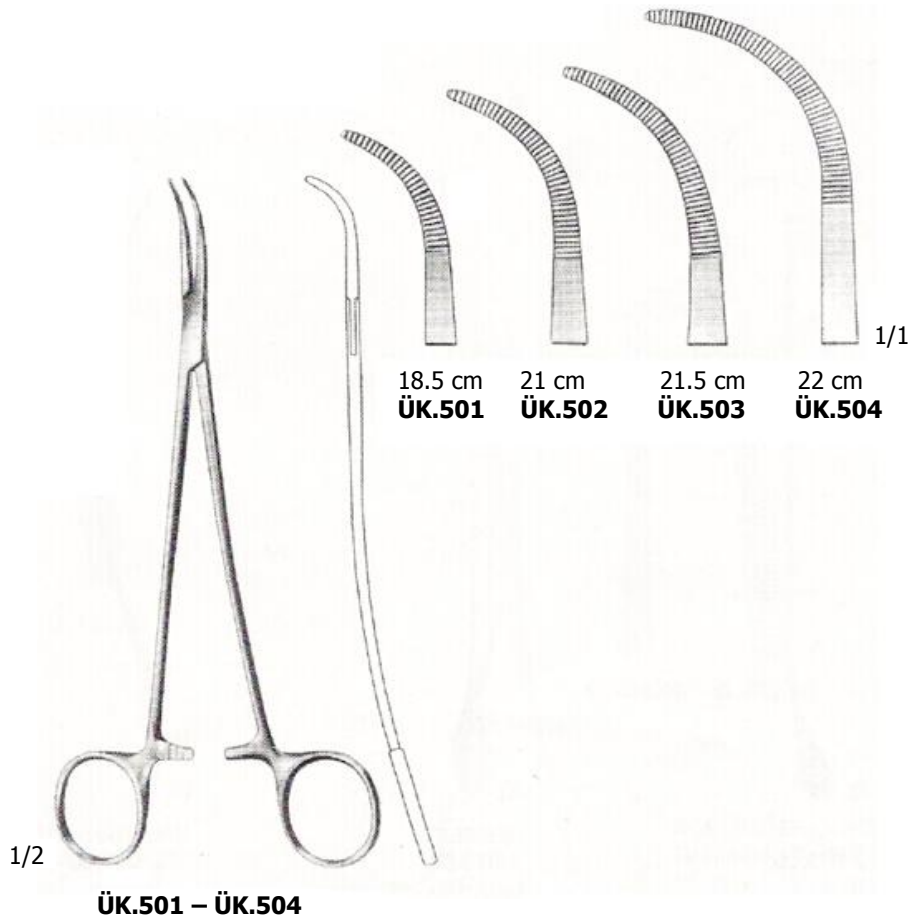
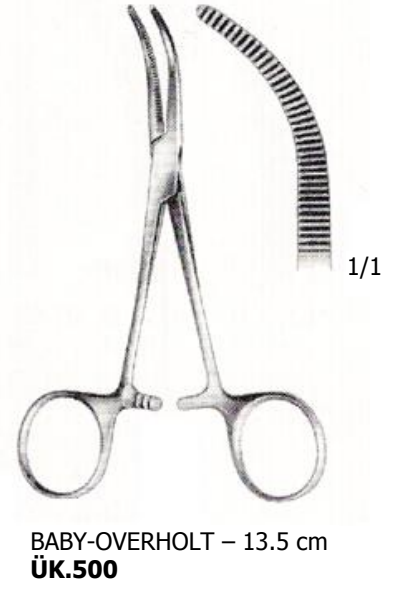
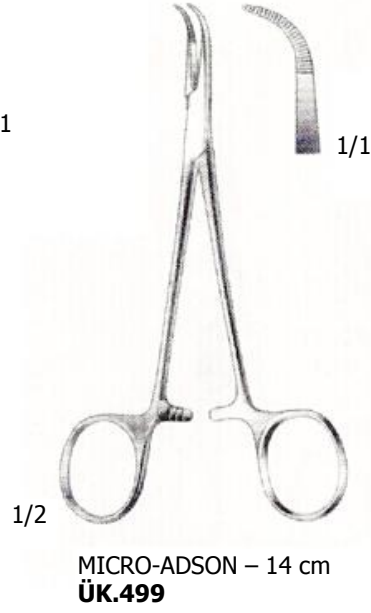

Ø 2.0 mm



13 cm **ÜK.506**
14.5 cm **ÜK.507**
16 cm **ÜK.508**
18 cm **ÜK.509**
20 cm **ÜK.510**

Ø 3.3 mm

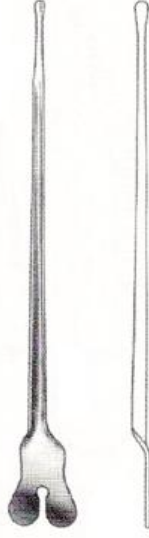

14 cm
ÜK.511

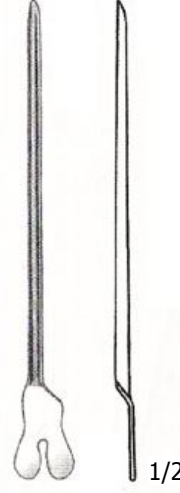

13 cm **ÜK.512**
14.5 cm **ÜK.513**
16 cm **ÜK.514**



BOWMAN – 13 cm
Bükülebilir/Malleable
Ø 0.7 mm + 0.8 mm **ÜK.515**
Ø 0.9 mm + 1.1 mm **ÜK.516**
Ø 1.3 mm + 1.4 mm **ÜK.517**
Ø 1.5 mm + 1.6 mm **ÜK.518**
Ø 1.8 mm + 1.9 mm **ÜK.519**

Ø 0.5 mm



1/2
SEIFFERT – 18 cm
Bükülebilir/Malleable
ÜK.520



1/2
KILLIAN – 16.5 cm
ÜK.521

Ø 1.4 mm



1/2
16 cm
ÜK.522



1/2
RITTER – 16 cm
Ø 2.5 mm **ÜK.523**
Ø 3.0 mm **ÜK.524**
Ø 4.0 mm **ÜK.525**
Ø 5.0 mm **ÜK.526**

Ø 3.5 mm



Bükülebilir/Malleable
25 cm **ÜK.527**
30 cm **ÜK.528**



Ø 2.0 mm **ÜK.529**
Ø 2.5 mm **ÜK.530**
Ø 3.0 mm **ÜK.531**

14.5 cm **ÜK.529**
16 cm **ÜK.530**
20 cm **ÜK.531**



Uç çapı
Diameter of tips

1mm	1.5 mm	2 mm
-	ÜK.533	-
ÜK.532	ÜK.534	ÜK.539
-	ÜK.535	ÜK.540
-	ÜK.536	ÜK.541
-	ÜK.537	ÜK.542
-	ÜK.538	-
-	-	ÜK.543

ÜK.532 – ÜK.543

Ø 0.8 mm



Uzunluk
Length

13 cm
14.5 cm
16 cm
18 cm
20 cm
25 cm
30 cm

1/2

STACKE – 10 cm
Bükülebilir/Malleable
ÜK.544

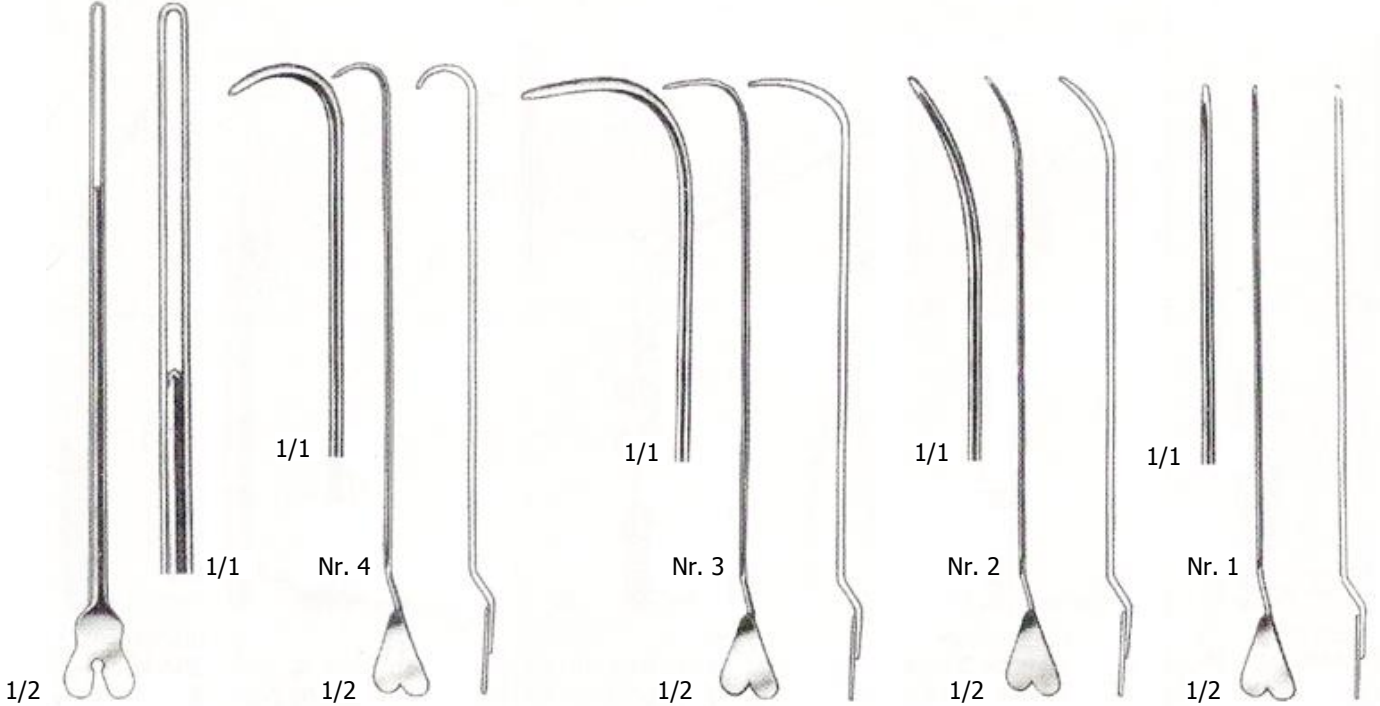

19 cm
Bükülebilir/Malleable
ÜK.545

LOCKHART-MUMMERY – 16.5 cm
Nr. 1. Düz/Straight **ÜK.546**
Nr. 2. 45° Eğri/Curved **ÜK.547**
Nr. 3. 90° Eğri/Curved **ÜK.548**
Nr. 4. Eğri/Curved **ÜK.549**

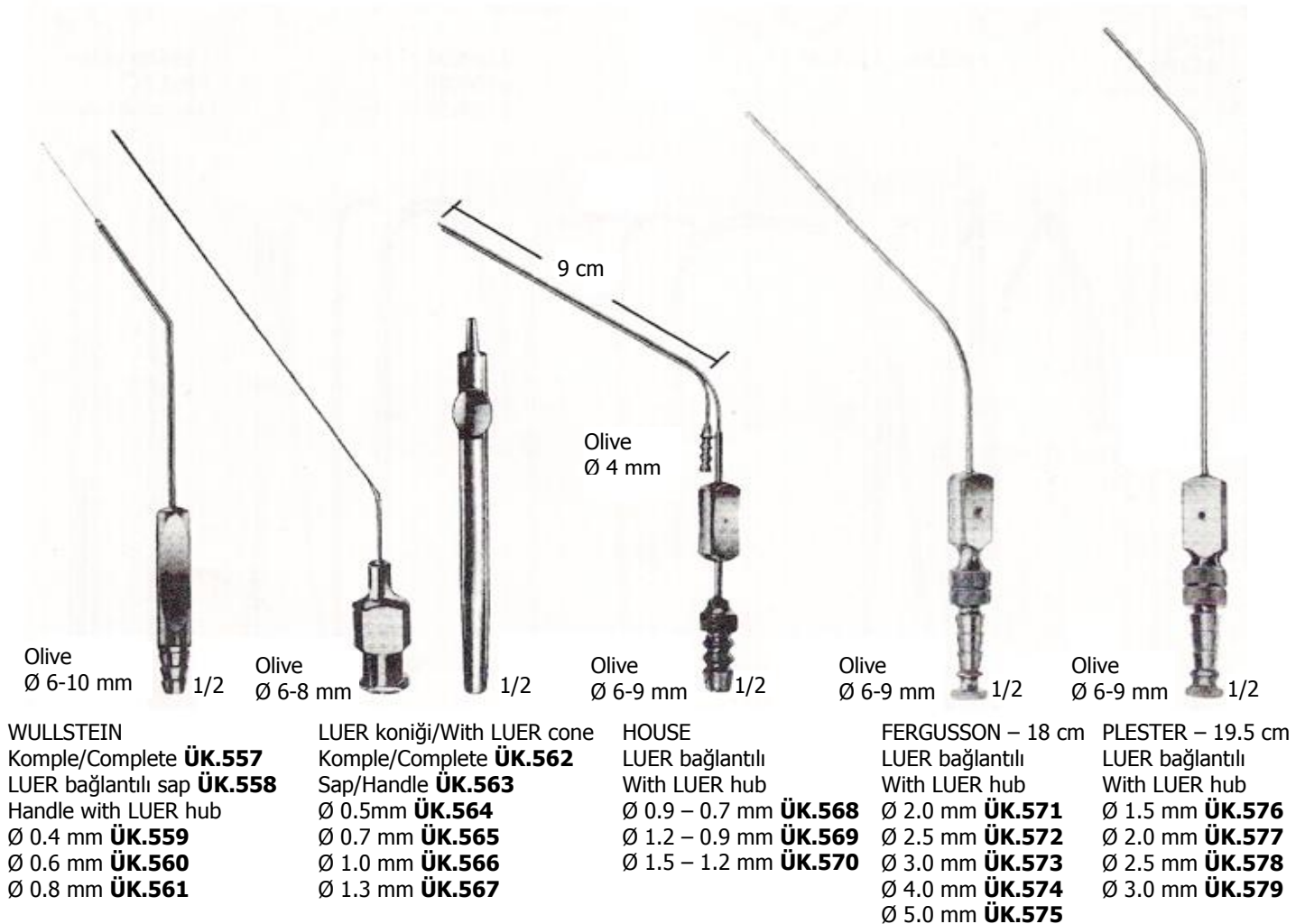
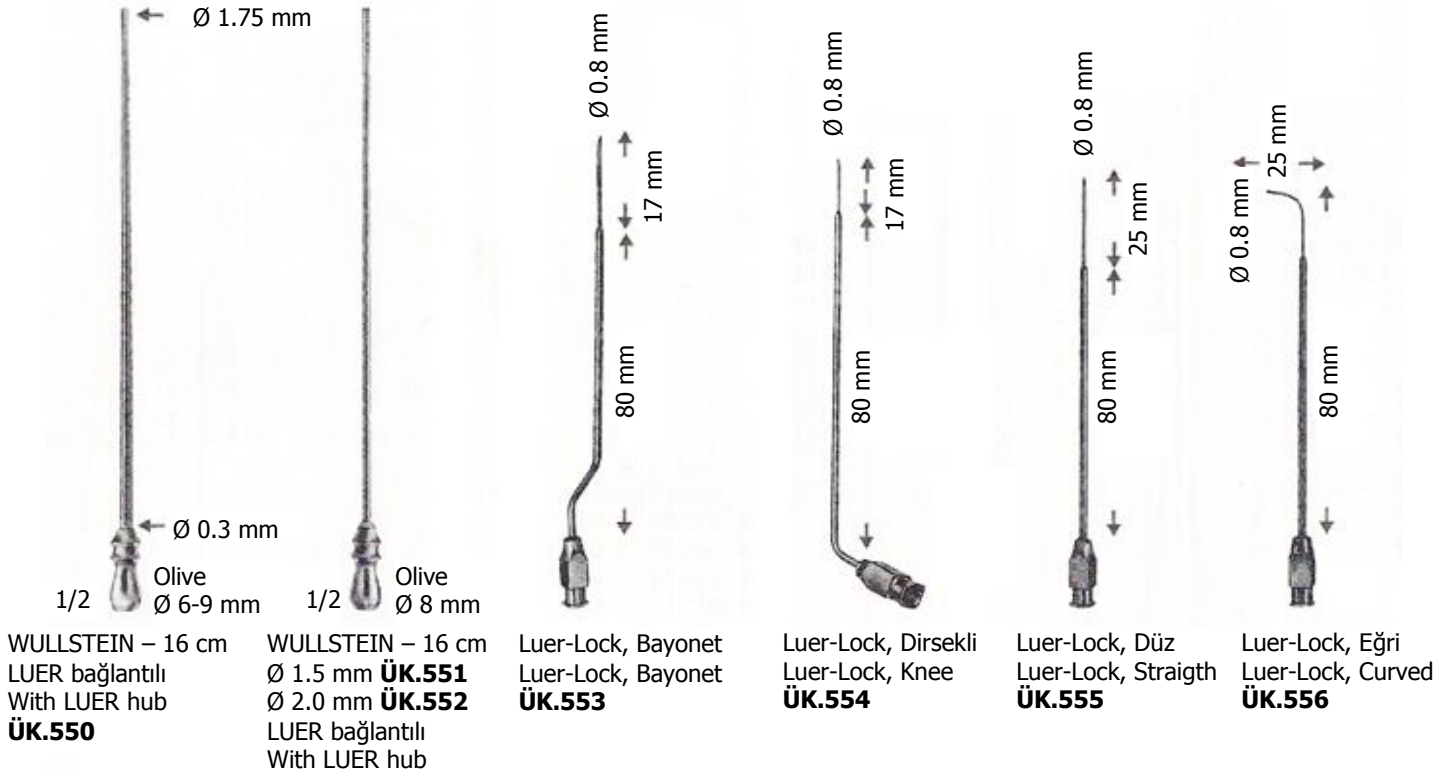

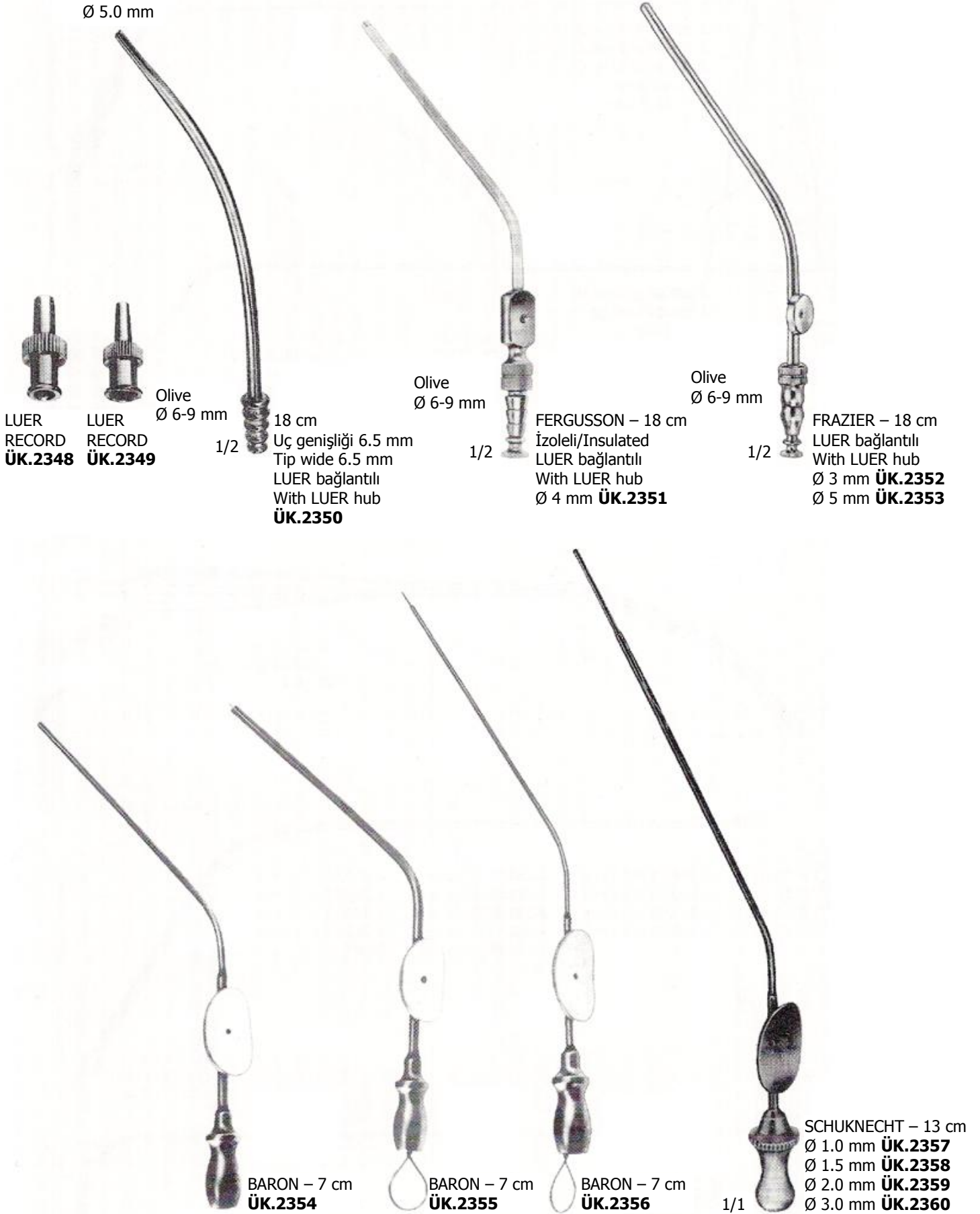

Ø 3.5 mm

Ø 2.0 mm

LUER bağlantılı
With LUER hub
35 cm **ÜK.580**
50 cm **ÜK.581**

Olive
Ø 9 mm 1/2

LUER-LOCK – 25 cm
Bayonet Uç **ÜK.585**
90° Açılı Uç **ÜK.586**

1/2

25 cm
LUER bağlantılı
With LUER hub
Ø 2.0 mm **ÜK.587**
Ø 2.5 mm **ÜK.588**
Ø 3.0 mm **ÜK.589**

Olive
Ø 6-9 mm 1/2

YANKUER – 28.5 cm
Ø 4.8 mm **ÜK.590**

Olive
Ø 7-9 mm

Ø 10 mm

YASARGIL – 13 cm
Ø 1.5 mm **ÜK.591**
Ø 2.0 mm **ÜK.592**
Ø 2.5 mm **ÜK.593**
Ø 3.5 mm **ÜK.594**

YASARGIL – 15 cm
Ø 1.5 mm **ÜK.595**
Ø 2.0 mm **ÜK.596**
Ø 2.5 mm **ÜK.597**
Ø 3.5 mm **ÜK.598**

YASARGIL – 18 cm
Ø 1.5 mm **ÜK.599**
Ø 2.0 mm **ÜK.600**
Ø 2.5 mm **ÜK.601**
Ø 3.5 mm **ÜK.602**
Ø 4.5 mm **ÜK.603**

YASARGIL – 22 cm
Ø 1.5 mm **ÜK.604**
Ø 2.0 mm **ÜK.605**
Ø 2.5 mm **ÜK.606**
Ø 3.5 mm **ÜK.607**

Olive
Ø 6.5-9 mm
LUER bağlantılı
With LUER hub 1/2



1/2
17.5 cm
Ø 4.5 mm **ÜK.608**
Ø 5.5 mm **ÜK.609**



1/2
BELLOCQ – 13 cm
Ø 2.5 mm **ÜK.610**



1/2
EICKEN – 13 cm
LUER bağlantılı
With LUER hub
Ø 2.5 mm **ÜK.611**
Ø 3.0 mm **ÜK.612**



1/2
SIEBENMANN – 13 cm
Künt/Blunt
Ø 2.5 mm **ÜK.613**
Ø 3.0 mm **ÜK.614**



1/2 **ÜK.615**



Olive
Ø 6-10 mm 1/2
20 cm
Sivri/Sharp
4 mm **ÜK.616**
5 mm **ÜK.617**



1/2
LANDOLT – 20 cm
Sivri/Sharp
3.2 mm **ÜK.618**

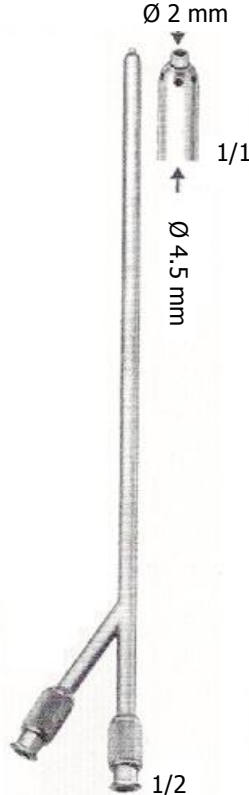

1/1
Ø 2 mm
Ø 4.5 mm
1/1
YASARGIL – 20 cm
LUER-LOCK koniği
LUER-LOCK cone
ÜK.619



1/2
GORNEY – 18 cm
ÜK.620



1/2
LICHTWITZ-BIER
20 cm
LUER bağlantılı
With LUER hub
Ø 1.5 mm **ÜK.621**
Ø 1.8 mm **ÜK.622**
Ø 2.0 mm **ÜK.623**



1/2
EICKEN – 20 cm
LUER bağlantılı
With LUER hub
Ø 1.5 mm **ÜK.624**
Ø 1.8 mm **ÜK.625**
Ø 2.0 mm **ÜK.626**
Ø 2.5 mm **ÜK.627**



1/2

PIERCE
Ø 4.0 mm **ÜK.628**



1/2

KRASUSE
Ø 4.0 mm **ÜK.629**

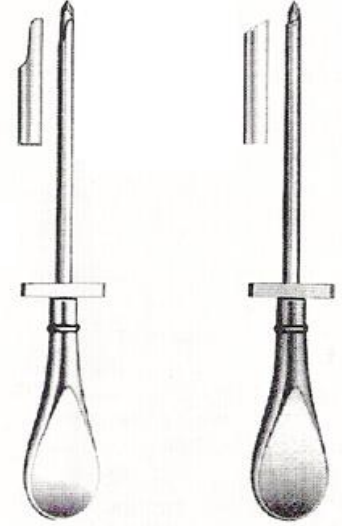

8.5 cm
Ø 5 mm **ÜK.630**

8.5 cm
Ø 5 mm **ÜK.631**



1/2

TILLEY LICHTWITZ – 20 cm
Ø 1.7 mm **ÜK.632**
Ø 2.0 mm **ÜK.633**

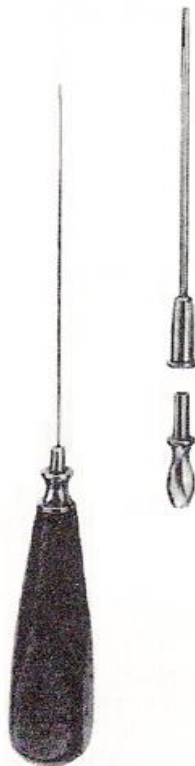

1/2

TILLEY LICHTWITZ – 18.5 cm
Ø 2.3 mm **ÜK.634**
Ø 2.7 mm **ÜK.635**



1/2

COAKLEY – 14 cm
Ø 3.0 mm **ÜK.636**

LUER-LOCK koniği
LUER-LOCK cone



LUER-LOCK – 4 cm
Ø 2.0 mm **ÜK.637**



LUER-LOCK – 10 cm
Ø 2.5 mm **ÜK.638**
Ø 3.0 mm **ÜK.639**



LUER-LOCK – 10 cm
Ø 2.5 mm **ÜK.640**
Ø 3.0 mm **ÜK.641**



LUER-LOCK – 10 cm
Ø 2.5 mm **ÜK.642**
Ø 3.0 mm **ÜK.643**



ACCELERATOR
2 mm 15 cm **ÜK.644**
3 mm 15 cm **ÜK.645**
4 mm 26 cm **ÜK.646**
5 mm 26 cm **ÜK.647**
6 mm 36 cm **ÜK.648**
8 mm 36 cm **ÜK.649**



JOHNSON EDGER
2 mm 15 cm **ÜK.650**
3 mm 15 cm **ÜK.651**
4 mm 26 cm **ÜK.652**
5 mm 26 cm **ÜK.653**
6 mm 36 cm **ÜK.654**
8 mm 36 cm **ÜK.655**



MERCEDES
2 mm 15 cm **ÜK.656**
3 mm 15 cm **ÜK.657**
4 mm 26 cm **ÜK.658**
5 mm 26 cm **ÜK.659**
6 mm 36 cm **ÜK.660**
8 mm 36 cm **ÜK.661**



ACCELERATOR
2 mm 15 cm **ÜK.662**
3 mm 15 cm **ÜK.663**
4 mm 26 cm **ÜK.664**
5 mm 26 cm **ÜK.665**
6 mm 36 cm **ÜK.666**
8 mm 36 cm **ÜK.667**



FOURNIER
2 mm 15 cm **ÜK.668**
3 mm 15 cm **ÜK.669**
4 mm 26 cm **ÜK.670**
5 mm 26 cm **ÜK.671**
6 mm 36 cm **ÜK.672**
8 mm 45 cm **ÜK.673**



LAS VEGAS
2 mm 15 cm **ÜK.674**
3 mm 15 cm **ÜK.675**
4 mm 26 cm **ÜK.676**
5 mm 26 cm **ÜK.677**
6 mm 36 cm **ÜK.678**
8 mm 36 cm **ÜK.679**



BECKER
2 mm 15 cm **ÜK.680**
3 mm 15 cm **ÜK.681**
4 mm 26 cm **ÜK.682**
5 mm 26 cm **ÜK.683**
6 mm 36 cm **ÜK.684**
8 mm 45 cm **ÜK.685**



SPATULA
2 mm 15 cm **ÜK.686**
3 mm 15 cm **ÜK.687**
4 mm 26 cm **ÜK.688**
5 mm 26 cm **ÜK.689**
6 mm 36 cm **ÜK.690**
8 mm 45 cm **ÜK.691**

STANDARD
2 mm 15 cm **ÜK.692**
3 mm 15 cm **ÜK.693**
4 mm 26 cm **ÜK.694**
5 mm 26 cm **ÜK.695**
6 mm 36 cm **ÜK.696**
8 mm 36 cm **ÜK.697**

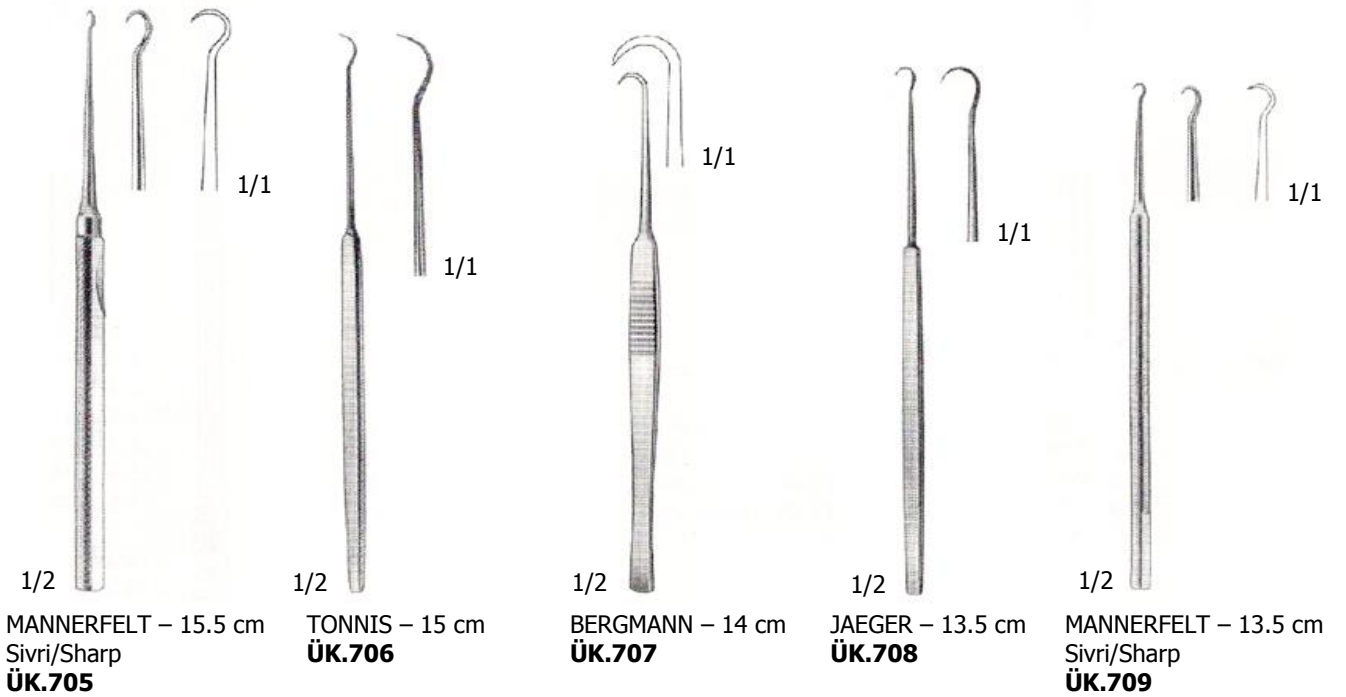
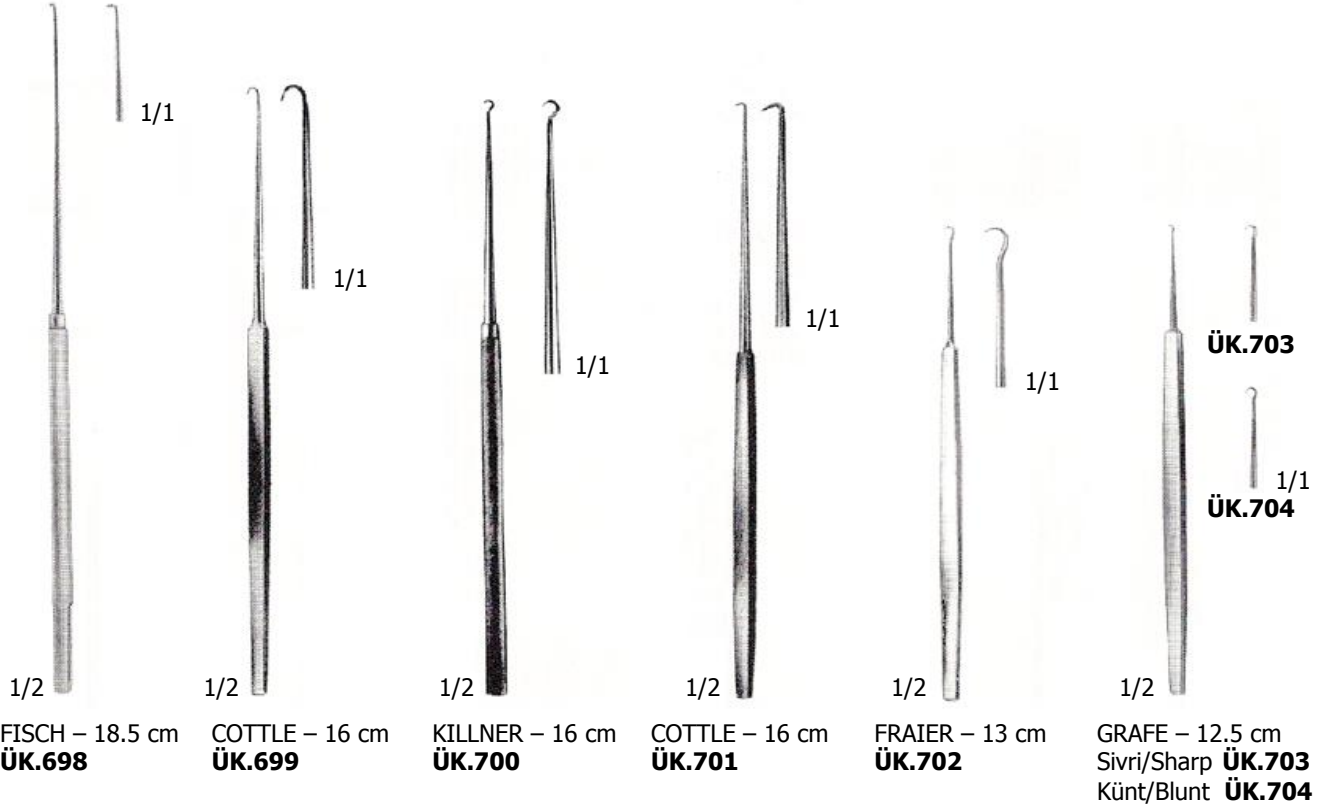

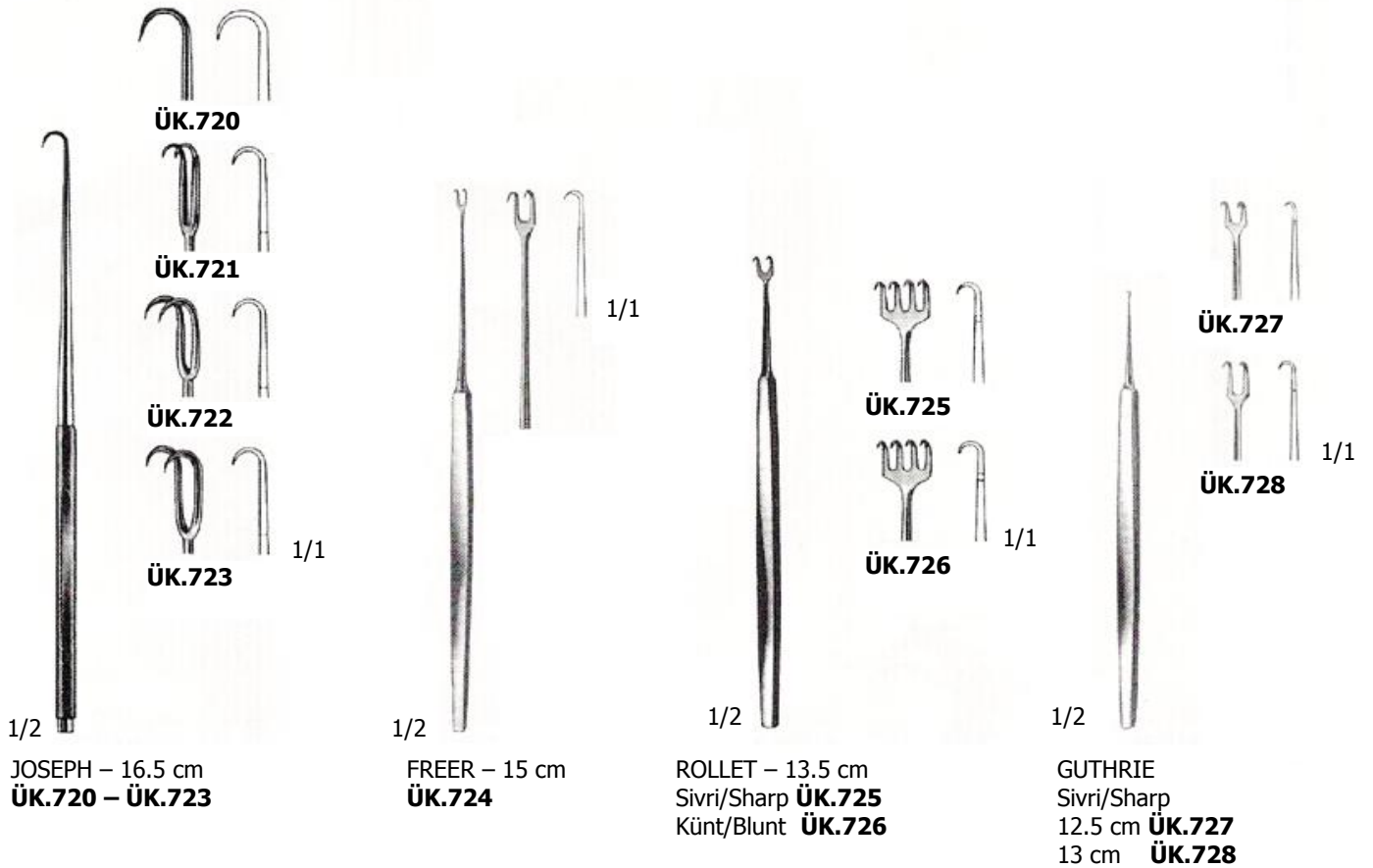
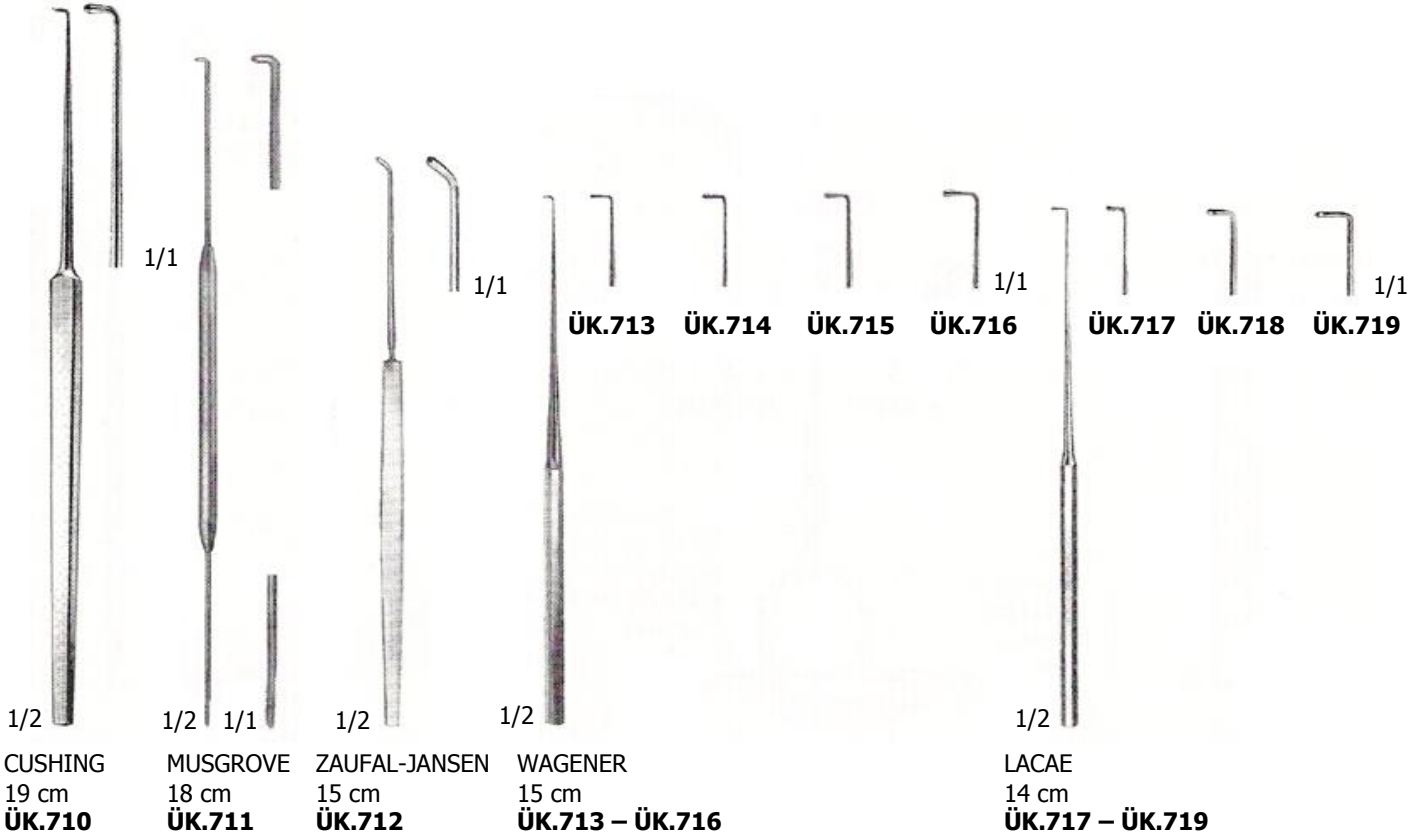



1/2
PENN SWIVEL – 13 cm
ÜK.729



1/2
MILLARD – 11 cm
ÜK.730

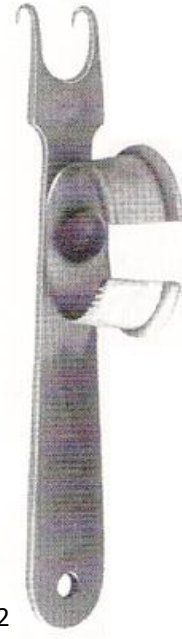

1/2
MILLARD – 8 cm
ÜK.731



1/2
MILLARD – 4 cm
ÜK.732



Ø 2.5 mm
ÜK.733



4 x 7 mm
1/1
ÜK.735



7 x 12 mm
ÜK.734 **ÜK.736**



7 x 12 mm
1/1



1/2
18.5 cm
ÜK.733



1/2
WILLIGER – 12 cm
Sivri/Sharp
ÜK.734 – ÜK.736

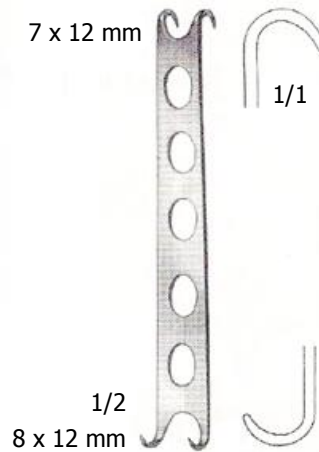

1/2
8 x 12 mm
CONVERSE – 12 cm
Künt/Blunt
ÜK.737

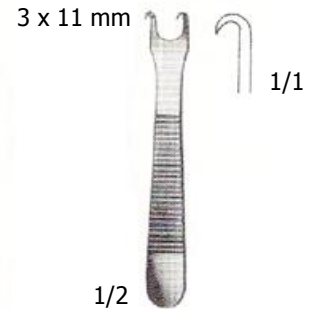

1/2
3 x 11 mm
KILNER – 8 cm
Sivri/Sharp
ÜK.738



1/2
COTTLE – 20 cm
Künt/Blunt
ÜK.739

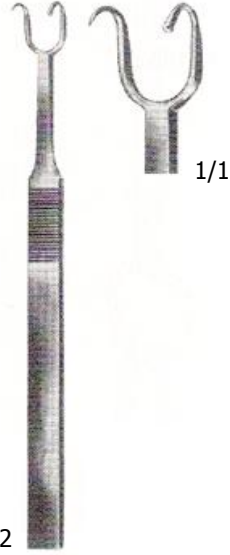

1/2
COTTLE – 14.5 cm
Sol Sivri/Left Sharp
ÜK.740



1/2
COTTLE – 14.5 cm
Sağ Sivri/Right Sharp
ÜK.741

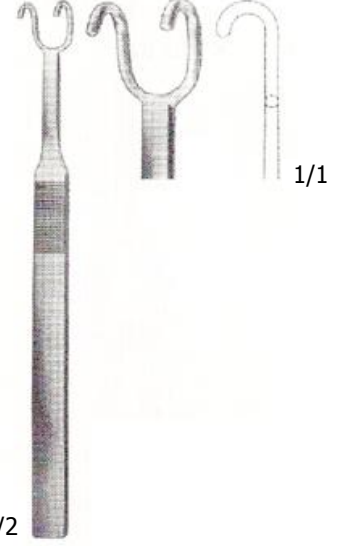

1/2
FOMON – 14.5 cm
Künt/Blunt
ÜK.742

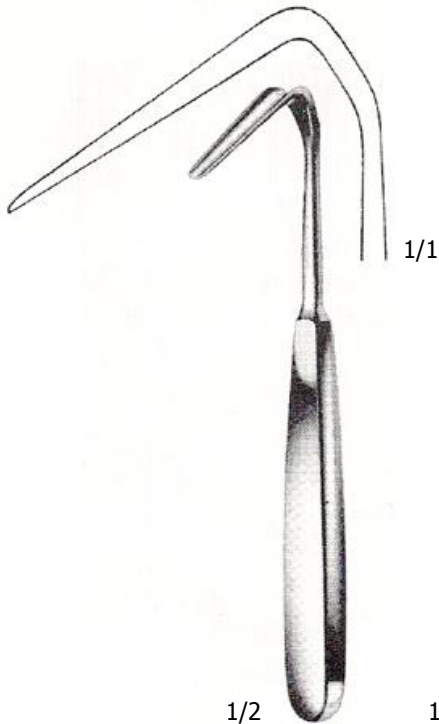

1/2
AUFRICHT – 16 cm
ÜK.743

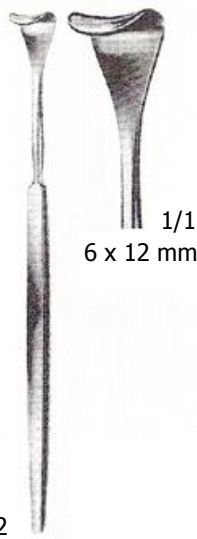

1/2
MASING – 14 cm
ÜK.744

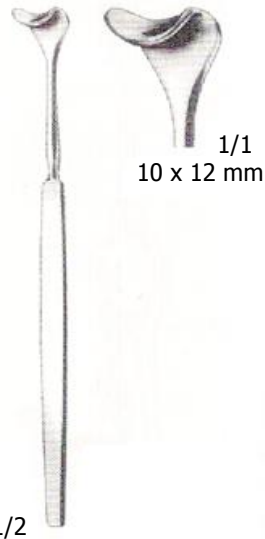

1/2
COTTLE – 14 cm
ÜK.745



1/2
WALTER – 13 cm
Künt/Blunt
ÜK.746

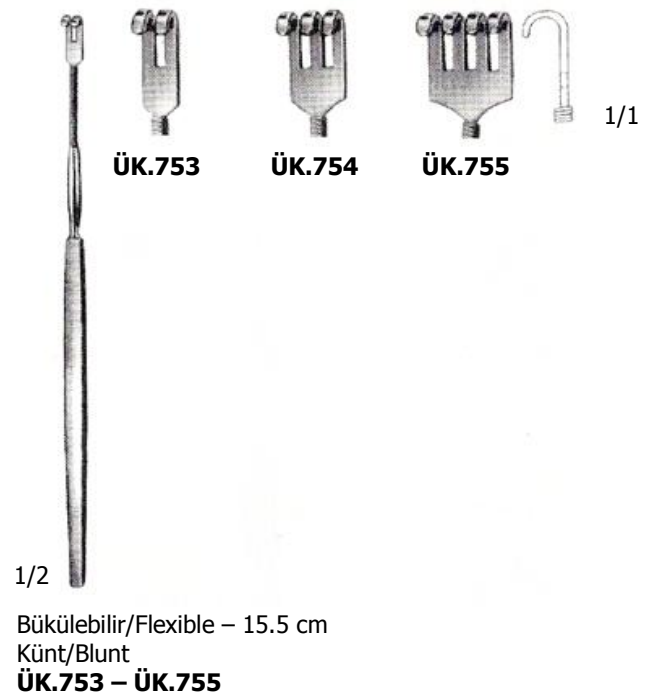
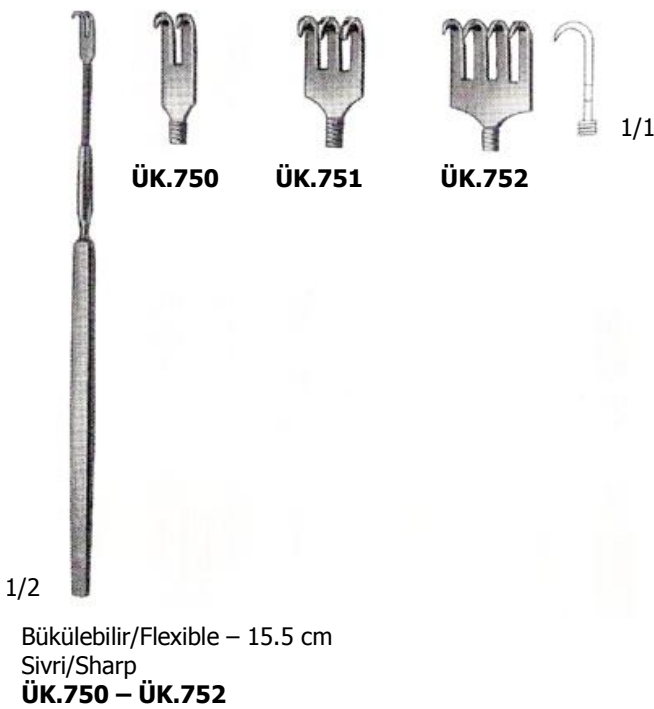
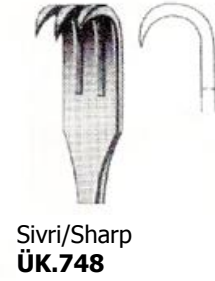
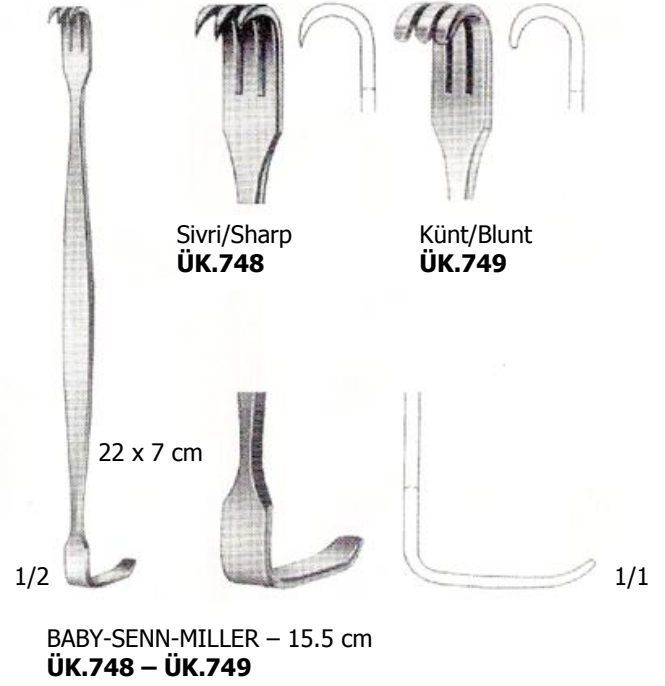

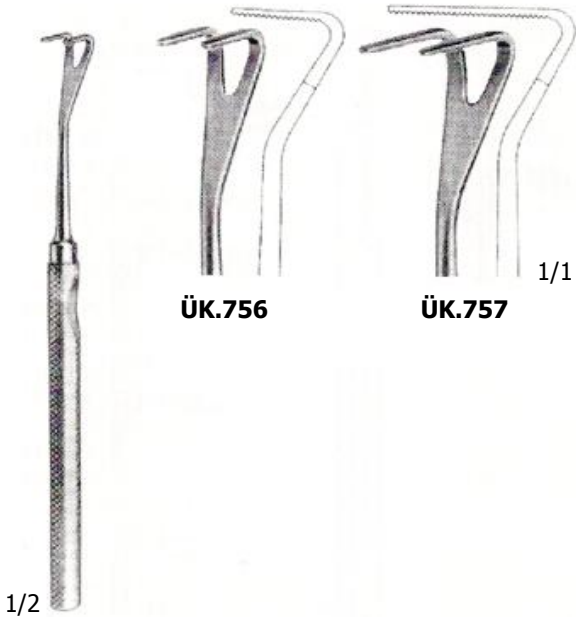

ÜK.756

ÜK.757

1/1

1/2

MANNERFELT – 15.5 cm
ÜK.756 – ÜK.757



1/2

MANNERFELT – 15.5 cm
Sivri/Sharp
ÜK.758

1/2

MANNERFELT – 15.5 cm
Bükülebilir küçük, sivri
Flexible small, sharp
ÜK.759

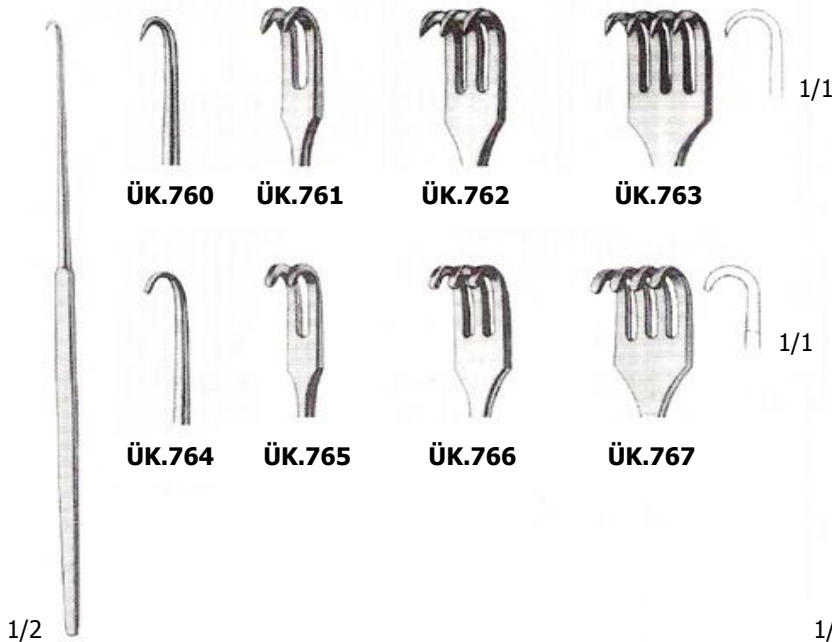

ÜK.760

ÜK.761

ÜK.762

ÜK.763

1/1

ÜK.764

ÜK.765

ÜK.766

ÜK.767

1/1

1/2

16.5 cm
Küçük/Small
Sivri/Sharp ÜK.760 – ÜK.763
Künt/Blunt ÜK.764 – ÜK.767

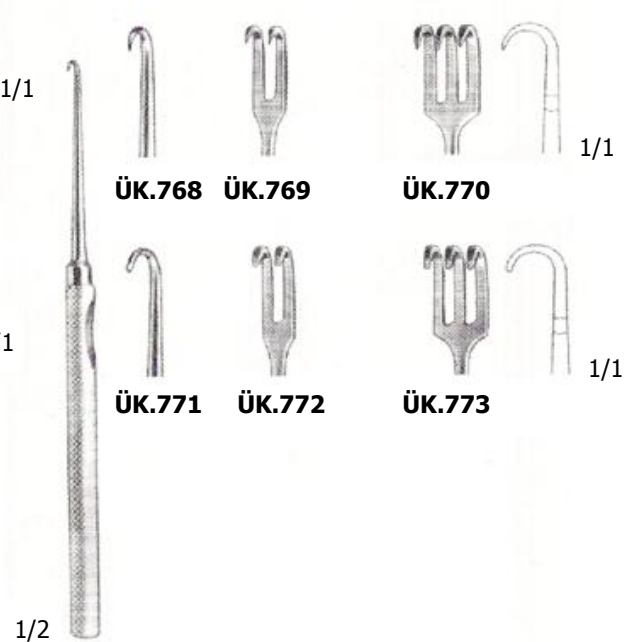

ÜK.768

ÜK.769

ÜK.770

1/1

ÜK.771

ÜK.772

ÜK.773

1/1

1/2

MANNERFELT – 16.5 cm
Küçük/Small
Sivri/Sharp ÜK.768 – ÜK.770
Künt/Blunt ÜK.771 – ÜK.773

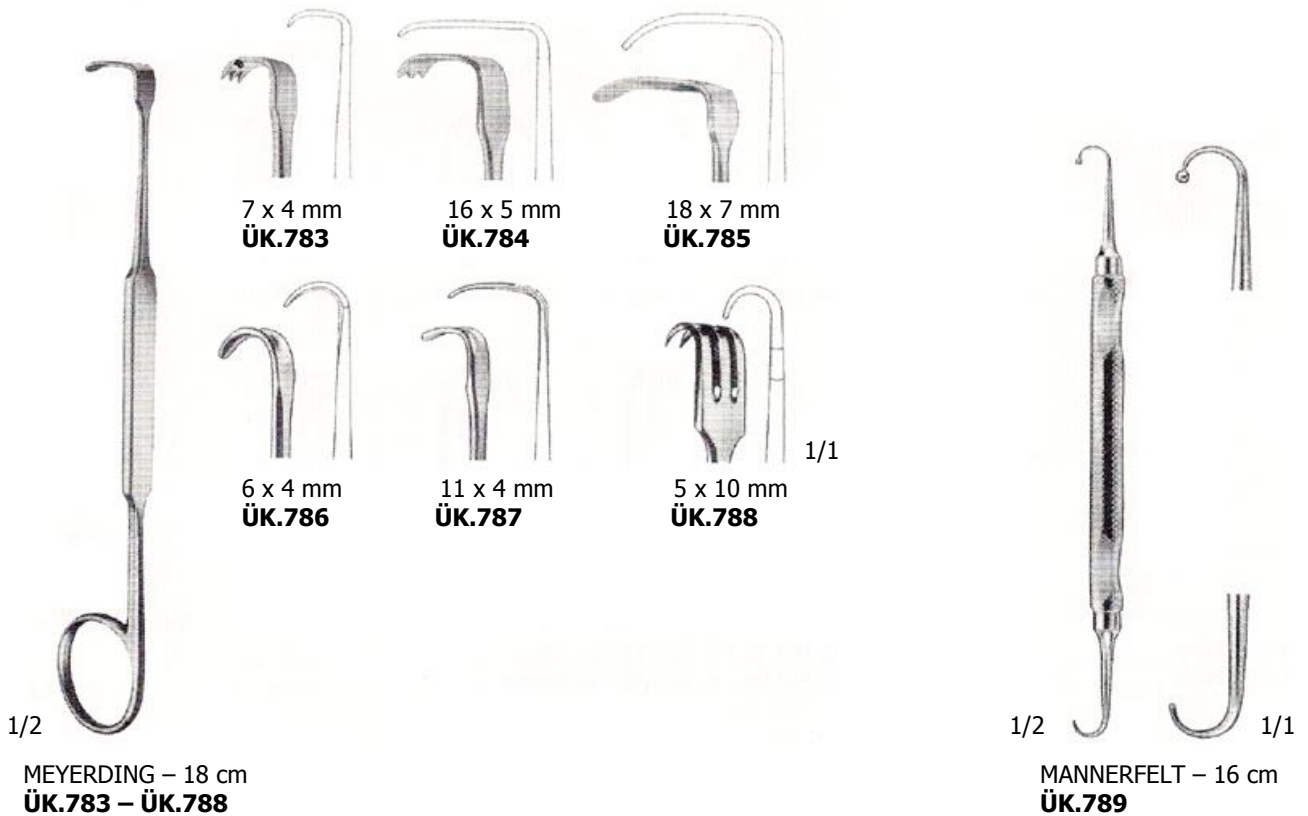
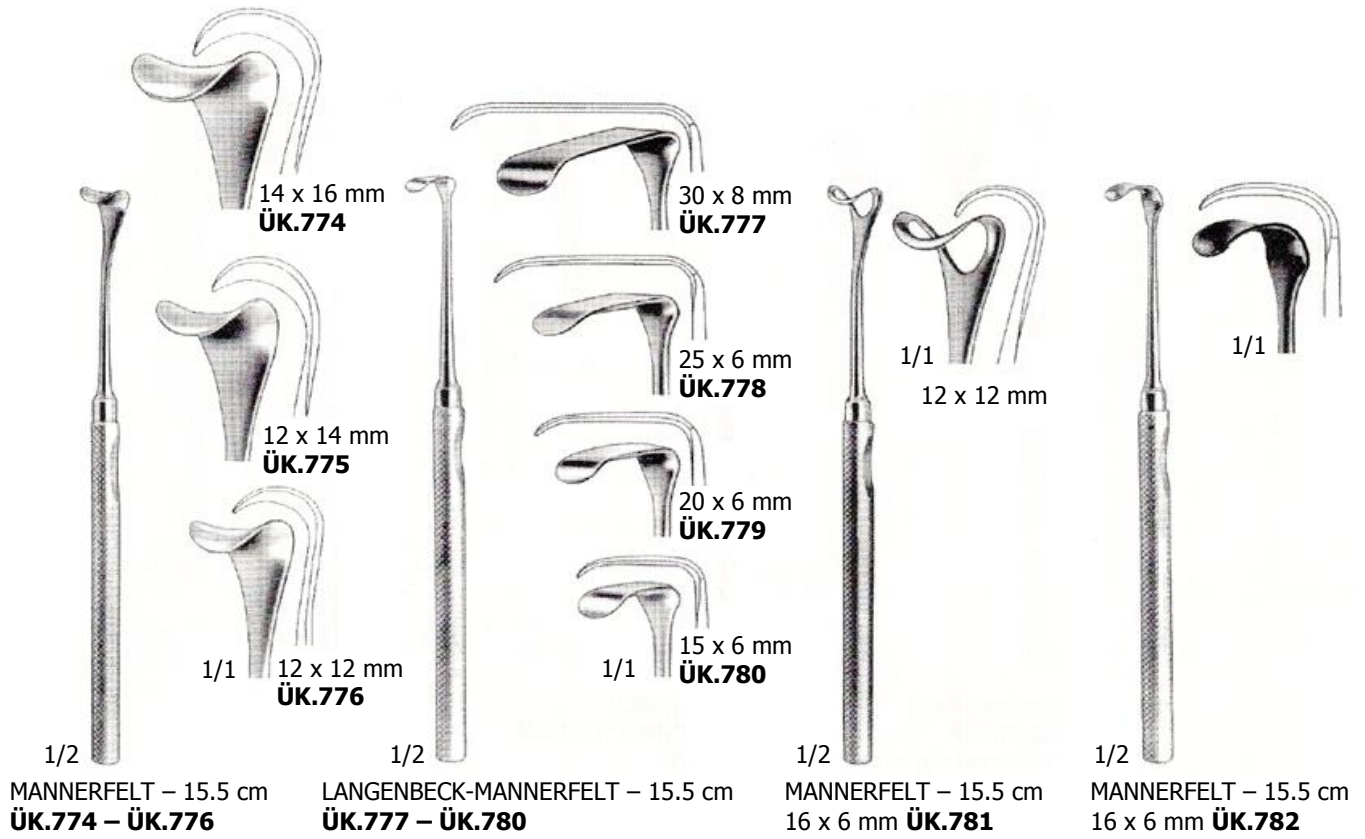



1/2
LANGENBECK-GREEN – 16 cm
ÜK.790 – ÜK.791

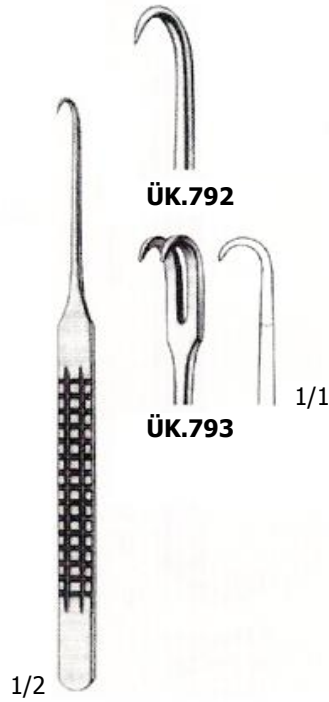

1/2
16 cm
Sivri/Sharp
ÜK.792 - ÜK.793

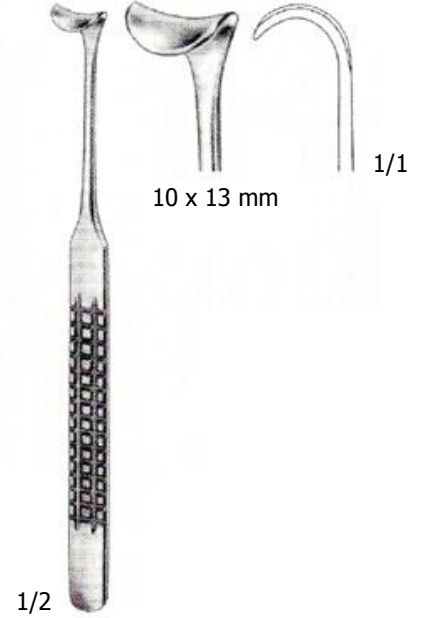

1/2
16 cm
ÜK.794

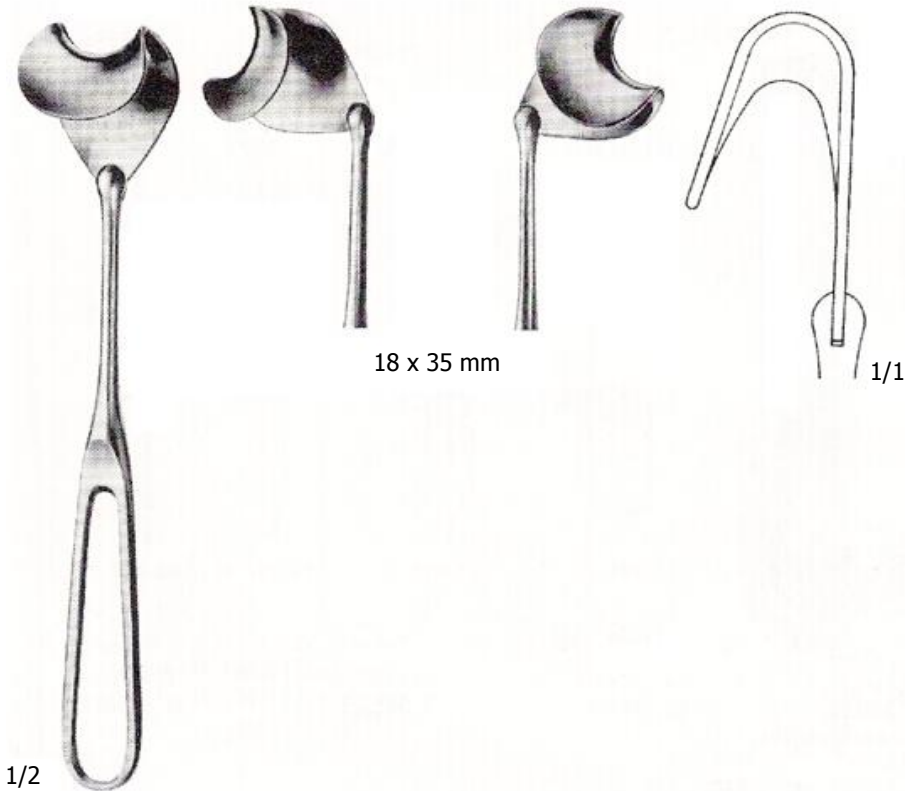

1/2
20.5 cm
ÜK.795

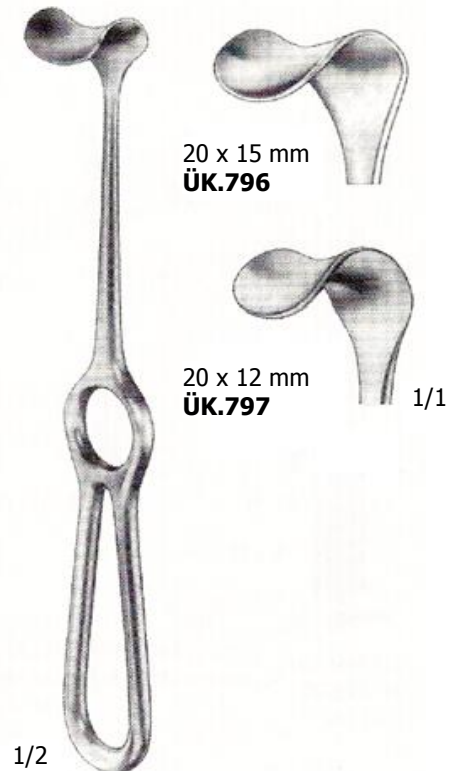

1/2
KOCHER – 20.5 cm
ÜK.796 – ÜK.797

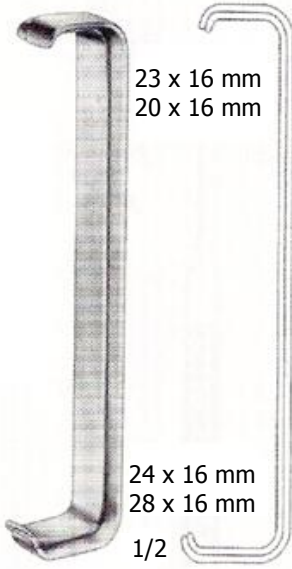

**FARABEUFG – 15 cm
ÜK.798**

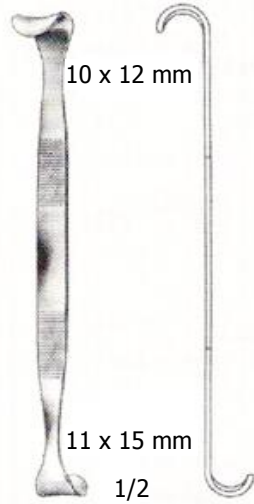

**ROSE – 13 cm
ÜK.799**

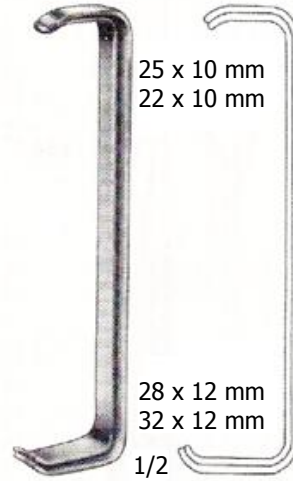

**FARABEUFG – 12.5 cm
ÜK.800**

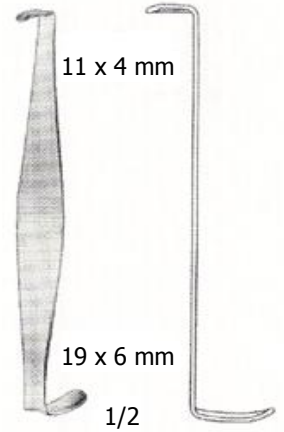

**CRILE – 11 cm
ÜK.801**

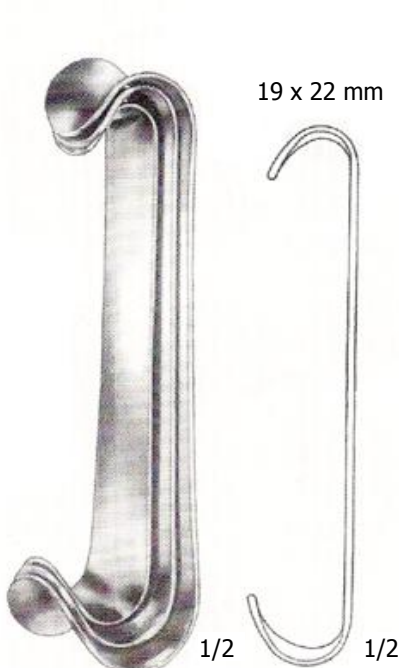

**ROUX – 16.5 cm
Komple/Complete
ÜK.802**

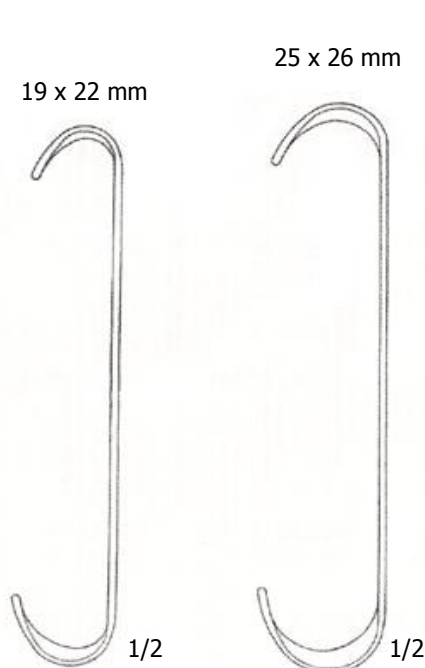

**23 x 30 mm
ÜK.803**

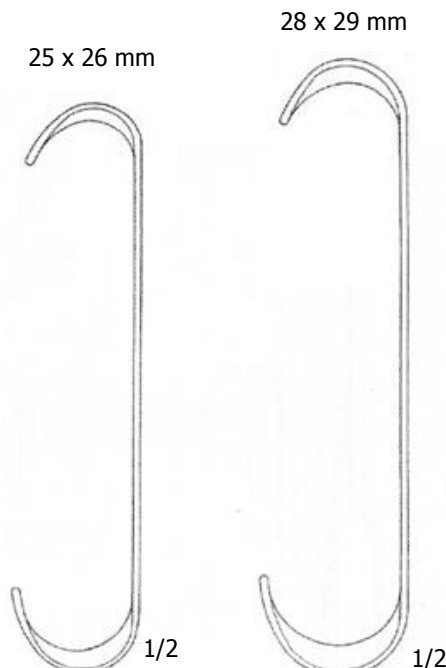

**28 x 38 mm
ÜK.804**



**33 x 45 mm
ÜK.805**

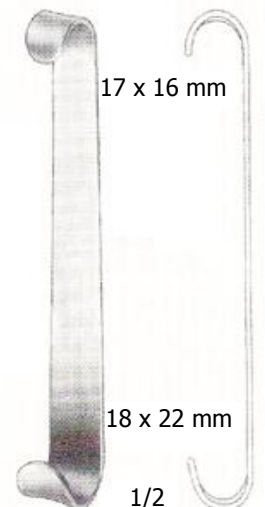

**BABY-ROUX – 13.5 cm
ÜK.806**



MIDDELDORPF
ÜK.807 – ÜK.809



28 x 28 mm
23.5 cm
ÜK.807



20 x 22 mm
21.5 cm
ÜK.808



15 x 15 mm
22 cm
ÜK.809



1/1



1/2
KOCHER
Sivri/Sharp
ÜK.810

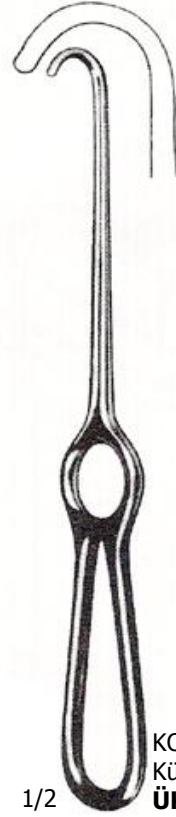

1/2
KOCHER
Künt/Blunt
ÜK.811

1/1

1/1



1/2
LANGENBECK – 21 cm
ÜK.812-ÜK.817

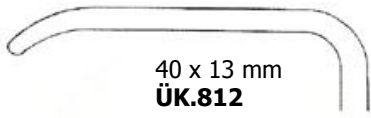

40 x 13 mm
ÜK.812

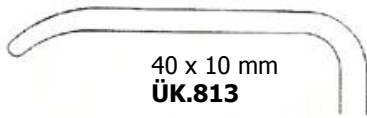

40 x 10 mm
ÜK.813

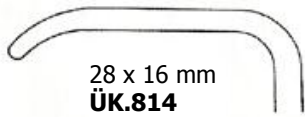

28 x 16 mm
ÜK.814

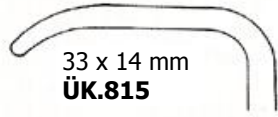

33 x 14 mm
ÜK.815

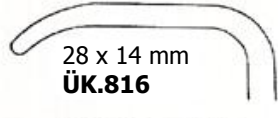

28 x 14 mm
ÜK.816

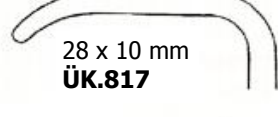

28 x 10 mm
ÜK.817

1/1



1/2
KOCHER-LANGENBECK – 21.5 cm
ÜK.818 – ÜK.822



35 x 15 mm
ÜK.818



35 x 11 mm
ÜK.819



35 x 8 mm
ÜK.820



25 x 8 mm
ÜK.821



25 x 6 mm
ÜK.822

1/1



150 x 30 mm
ÜK.823

1/2

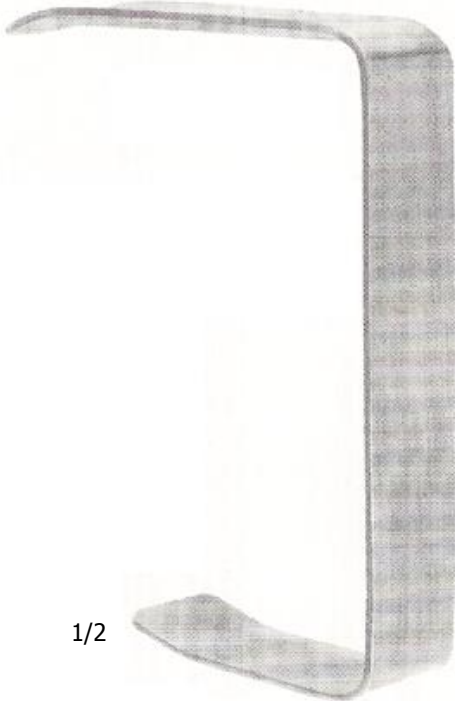

1/2

OZUN
ÜK.824

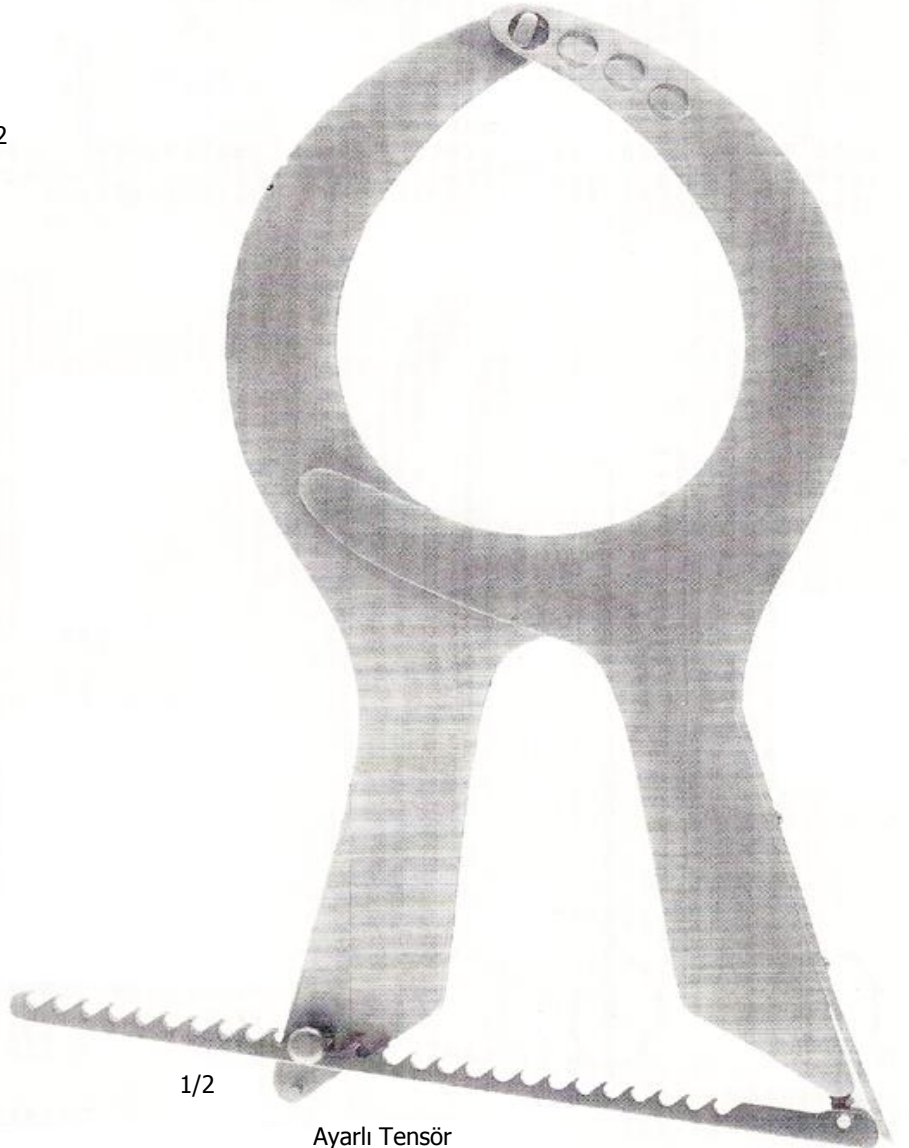

1/2

Ayarlı Tensör
Adjustable Tensor
ÜK.825



1/2
AGRIS-DINGMANN
Sağ/Right **ÜK.836**
Sol/Left **ÜK.837**



1/2
Ø 35 mm **ÜK.826**
Ø 40 mm **ÜK.827**
Ø 45 mm **ÜK.828**
Ø 50 mm **ÜK.829**
Ø 55 mm **ÜK.830**

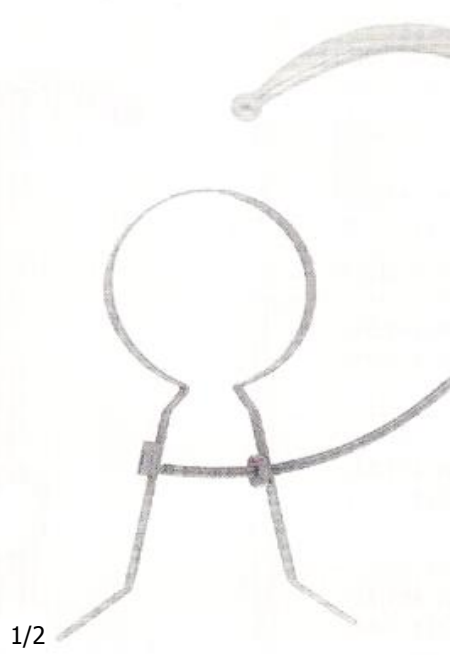

1/2
Ø 35 mm **ÜK.831**
Ø 40 mm **ÜK.832**
Ø 45 mm **ÜK.833**
Ø 50 mm **ÜK.834**
Ø 55 mm **ÜK.835**

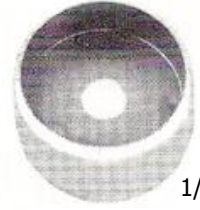

1/2
Meme Markörü
Aerola Marker
38 x 42 mm
ÜK.841



1/2
Meme Kesme Markörü
Aerola Cutting Marker
38 x 42 mm
ÜK.842



1/2
OZUN
Meme Markörü
Aerola Marker
38 x 42 mm
ÜK.843

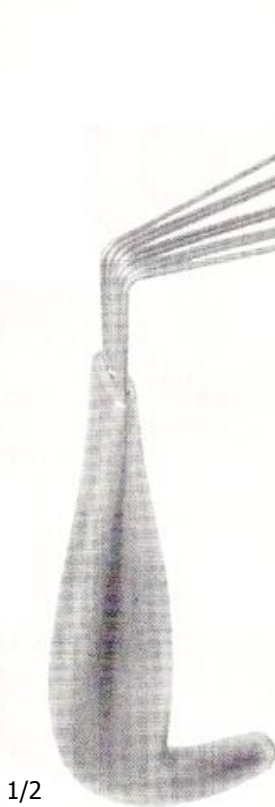

1/2
Küçük Boy/Small Size
ÜK.838

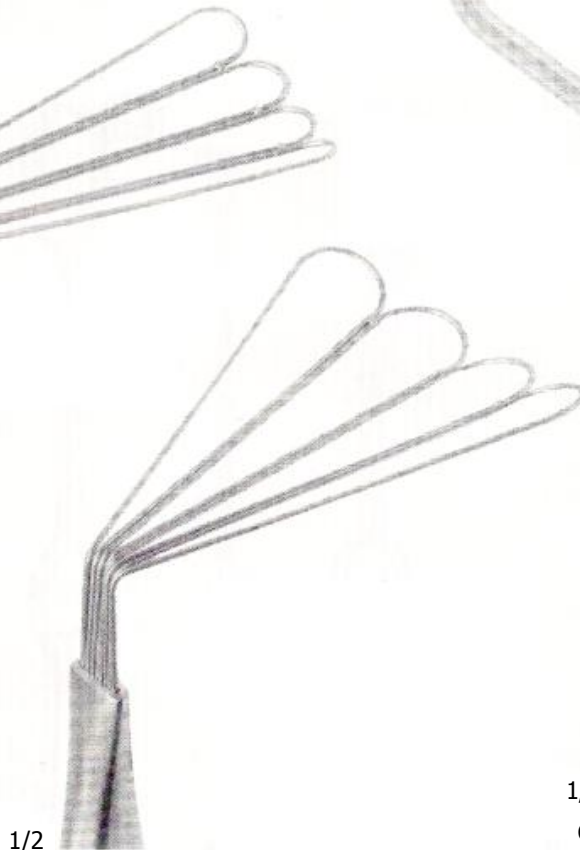

1/2
Büyük Boy/Large Size
ÜK.839



1/2
GRECO-SIMONS
ÜK.840

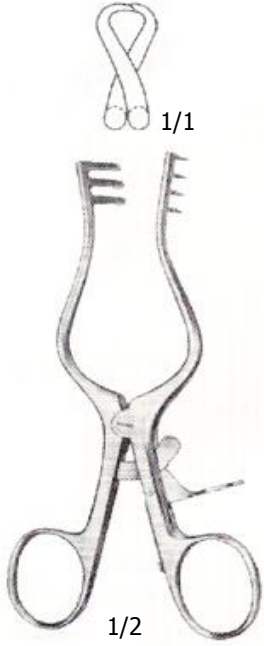

WEITLANER – 13 cm
Sivri/Sharp **ÜK.844**

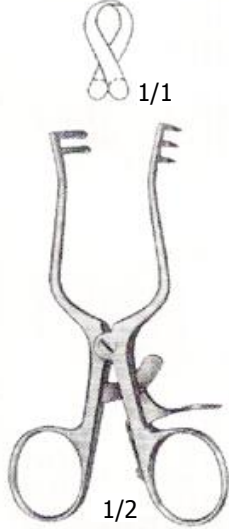

WEITLANER – 11 cm
Sivri/Sharp **ÜK.845**

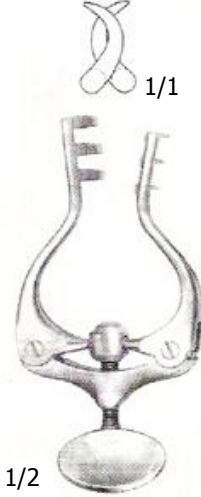

JANSEN – 10 cm
Sivri/Sharp
ÜK.846



10 cm
Künt/Blunt
ÜK.847



ALLPORT – 9.5 cm
Sivri/Sharp
ÜK.848



Künt/Blunt
7 cm **ÜK.849**
10 cm **ÜK.850**

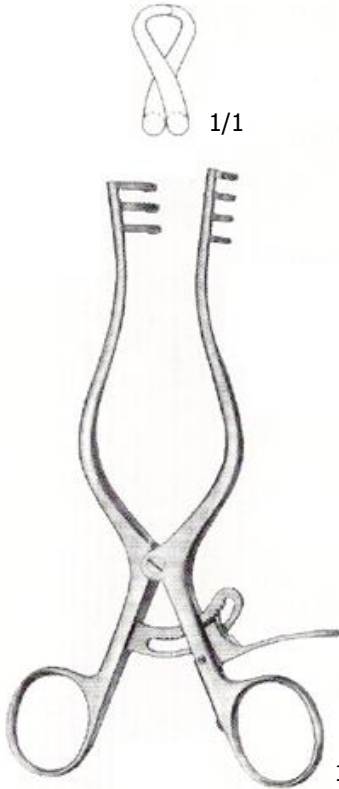

WEITLANER – 16.5 cm
Künt/Blunt **ÜK.851**



Komple/Complete **ÜK.852**
ÜK.853 – ÜK.857

17.5 cm
Sadece Ekartör
Retractor Only
ÜK.853



9 cm
ÜK.854

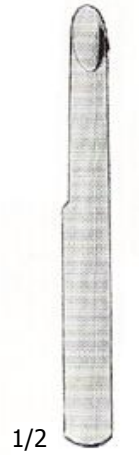

12 cm
10 x 12 mm
ÜK.855



15 cm
10 x 12 mm
ÜK.856



15 cm
10 x 12 mm
Eğri/Curved
ÜK.857

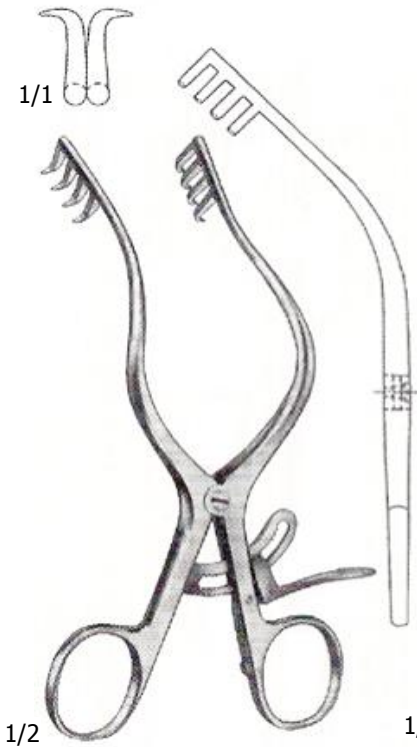

MOLLISON – 15.5 cm
Sivri/Sharp **ÜK.858**

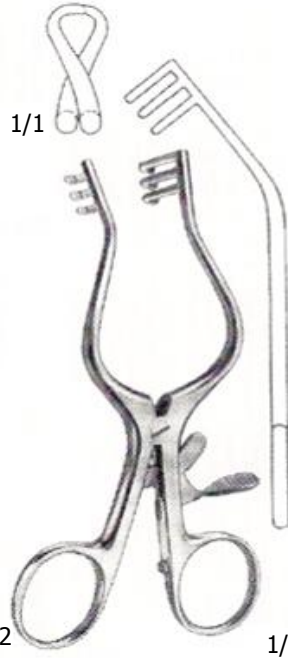

WULLSTEIN – 13 cm
Künt/Blunt **ÜK.859**

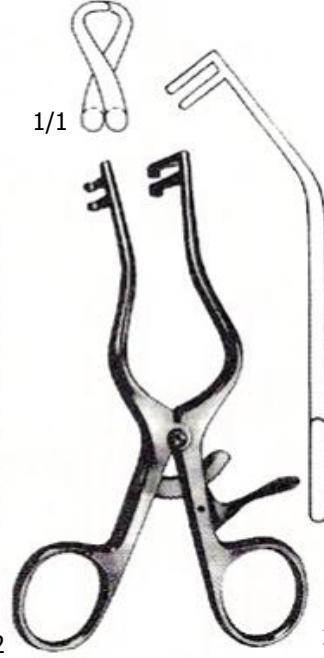

PLESTER – 13 cm
Künt/Blunt **ÜK.860**



ADSON-BABY – 14 cm
Sivri/Sharp **ÜK.861**
Künt/Blunt **ÜK.862**

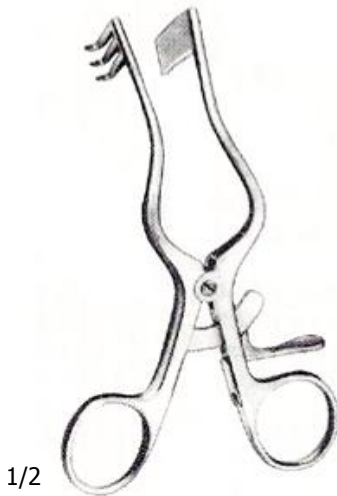

PERKINS – 13 cm
Sağ/Right **ÜK.863**

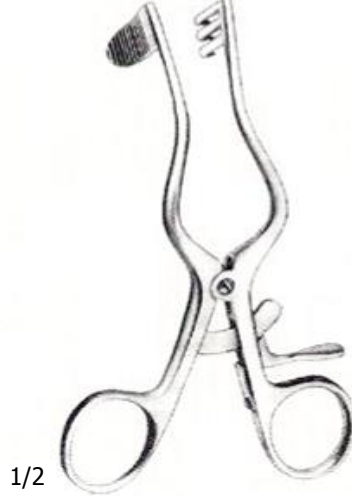

PERKINS – 13 cm
Sol/Left **ÜK.864**

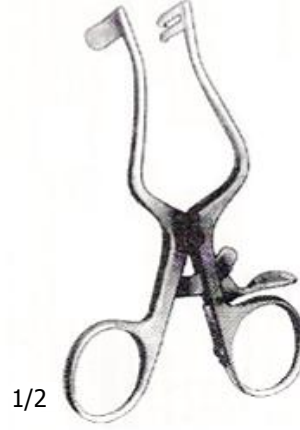
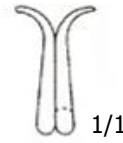

PLESTER – 11 cm
Künt/Blunt
Sol/Left **ÜK.865**

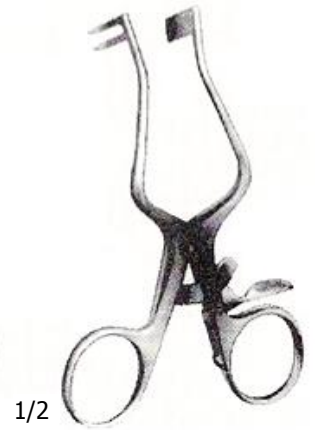

PLESTER – 11 cm
Künt/Blunt
Sağ/Right **ÜK.866**

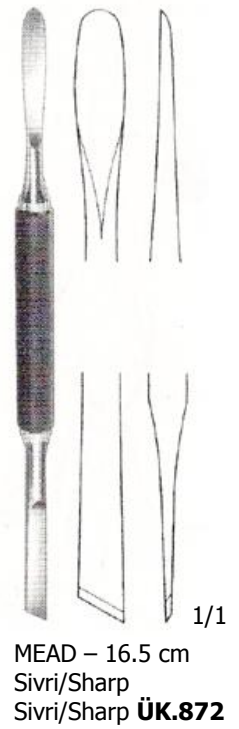
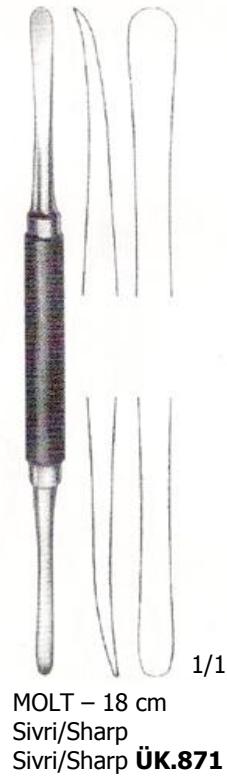
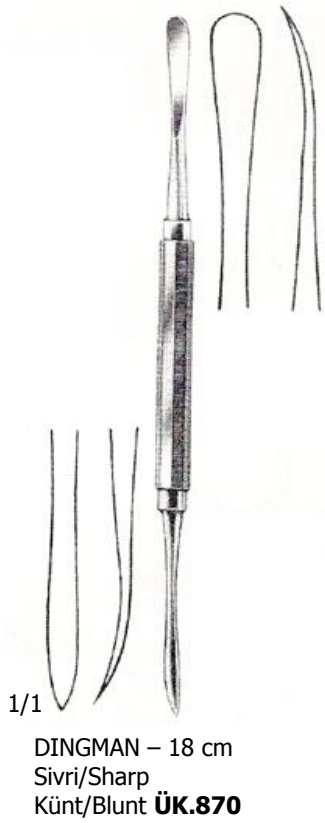
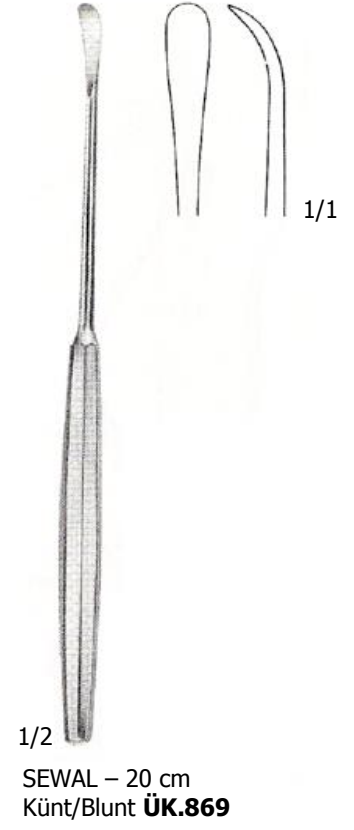

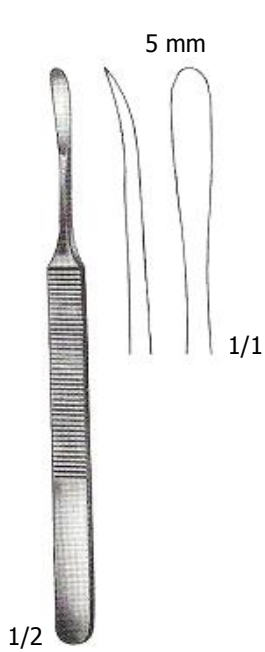

KÖNIG – 15.5 cm
ÜK.873

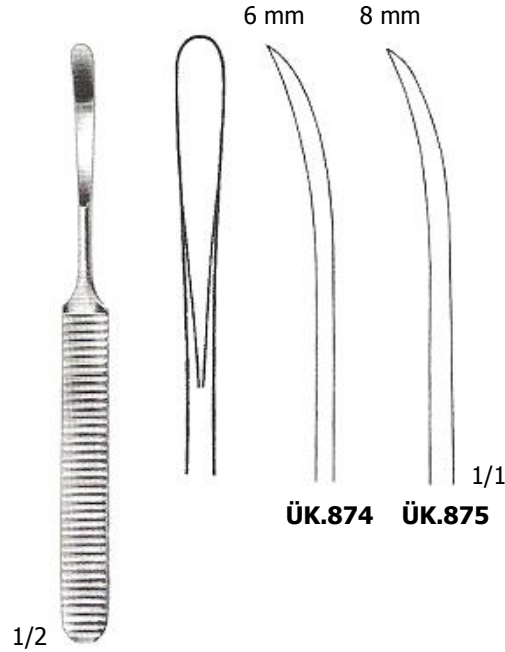

WILLIGER – 16 cm
ÜK.874 – ÜK.875

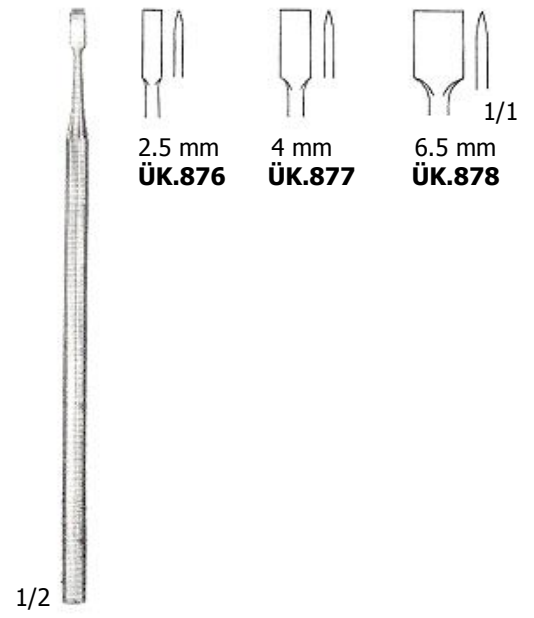

OBWEGESER – 15 cm
ÜK.876 – ÜK.878

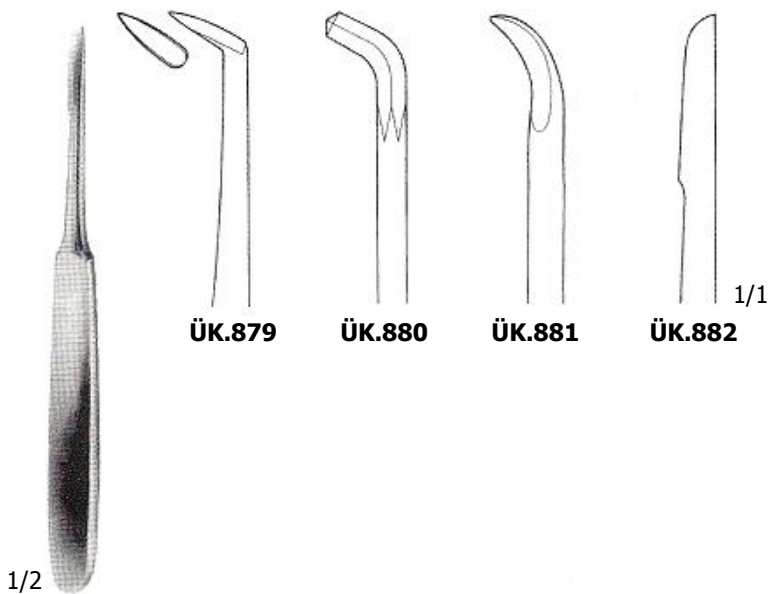

CHOMPRET – 15 cm
ÜK.879 – ÜK.882

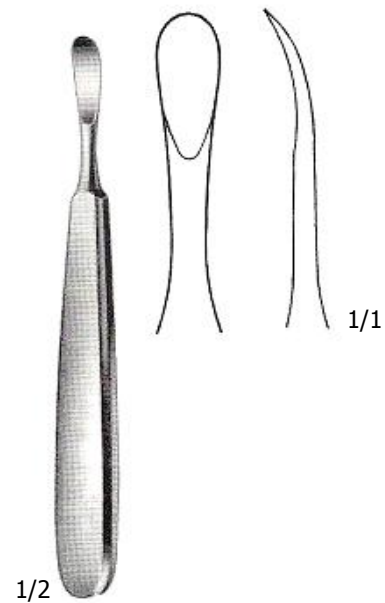

TRELAT – 15 cm
ÜK.883



STEINHAUSER
17 cm
4 mm **ÜK.884**

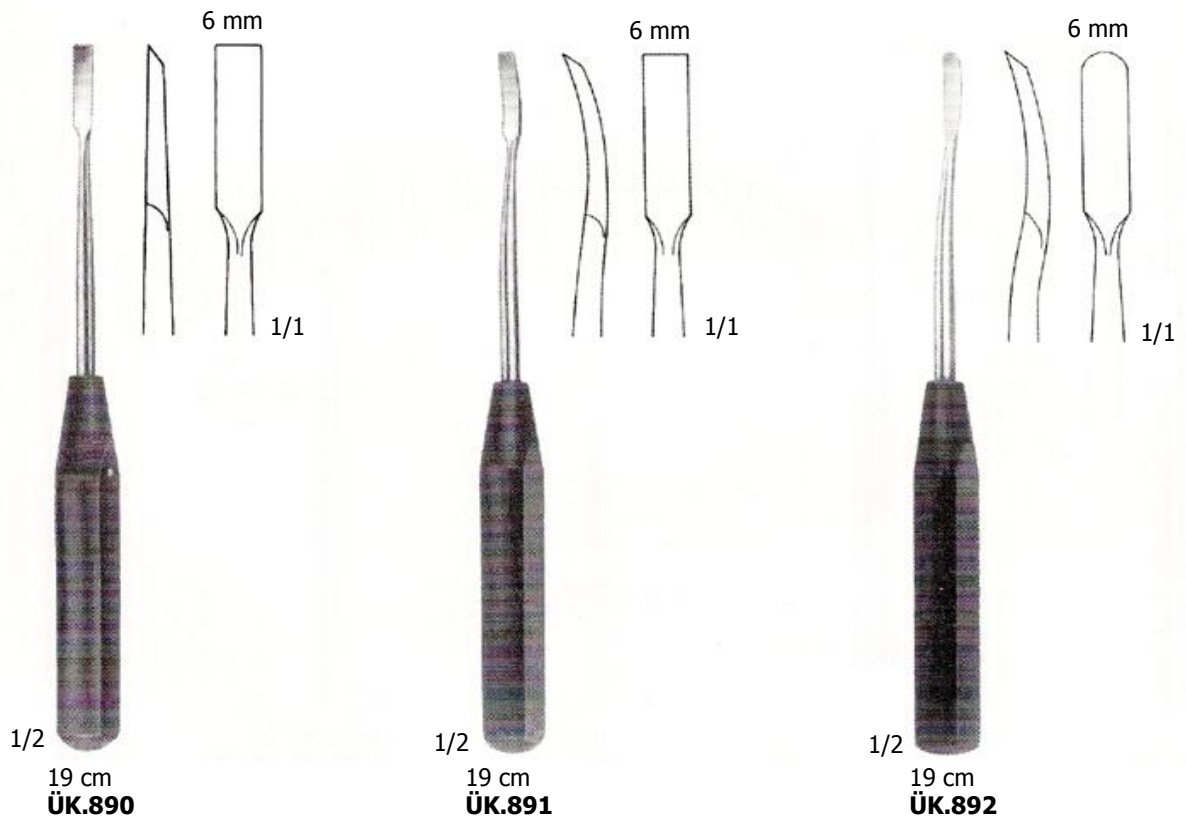
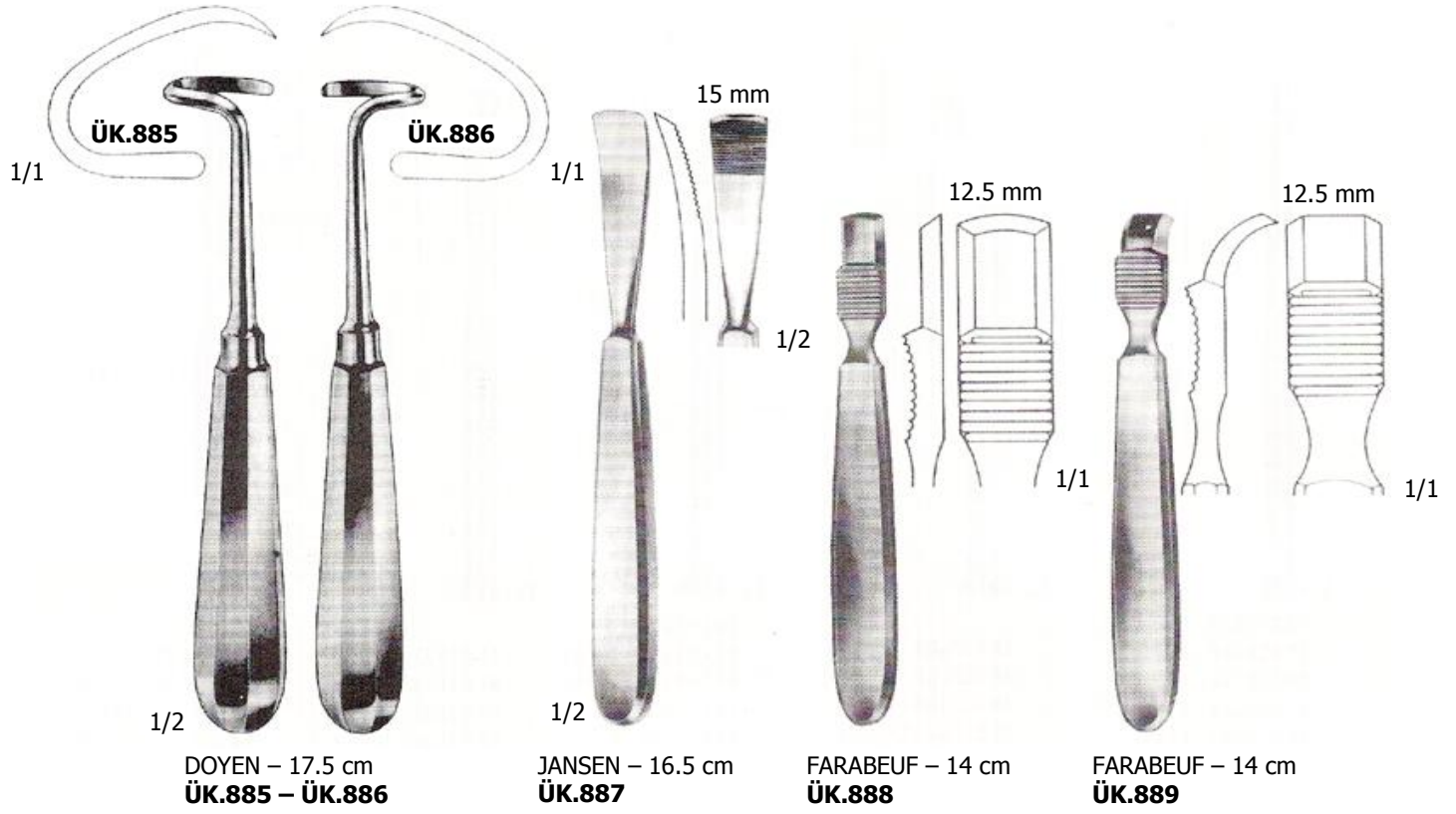

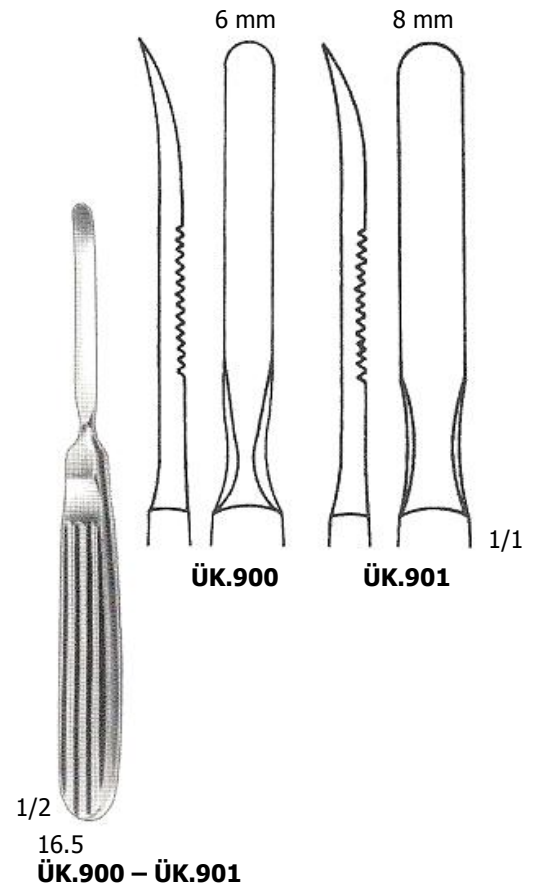
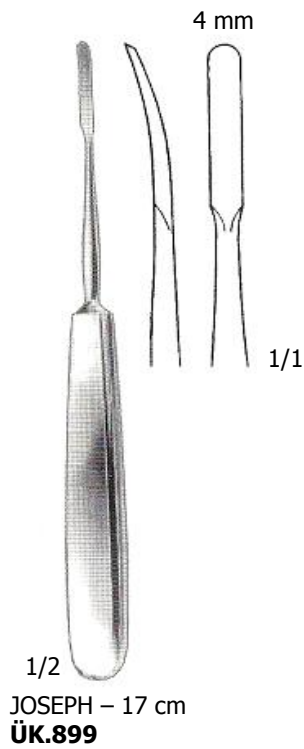
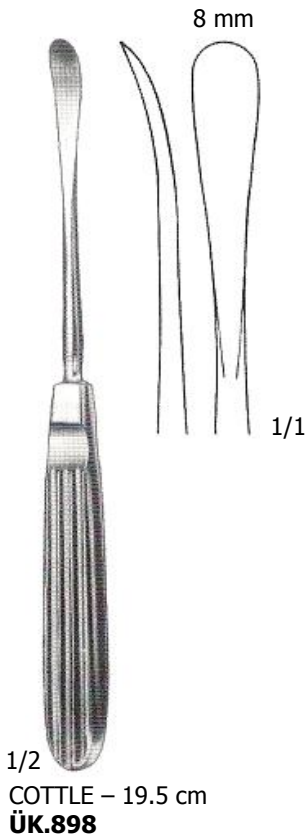
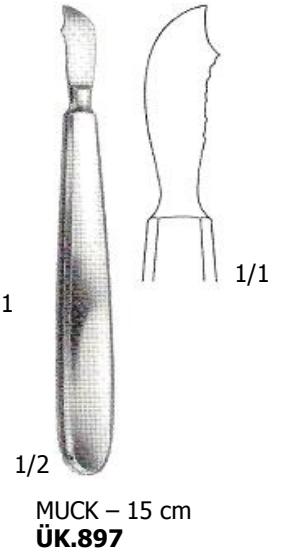
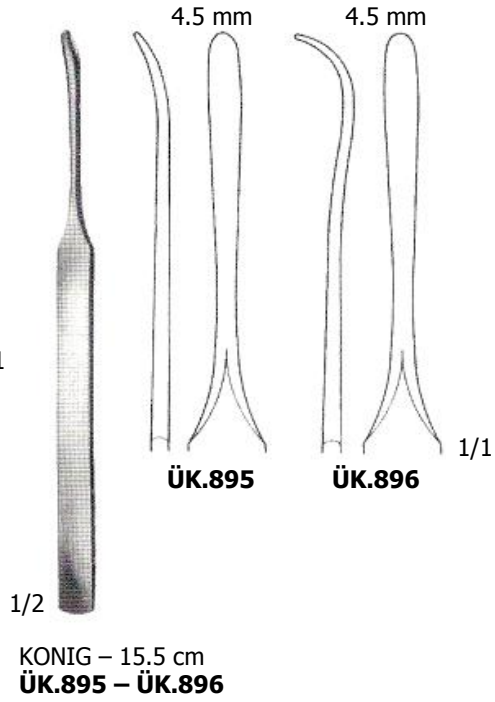
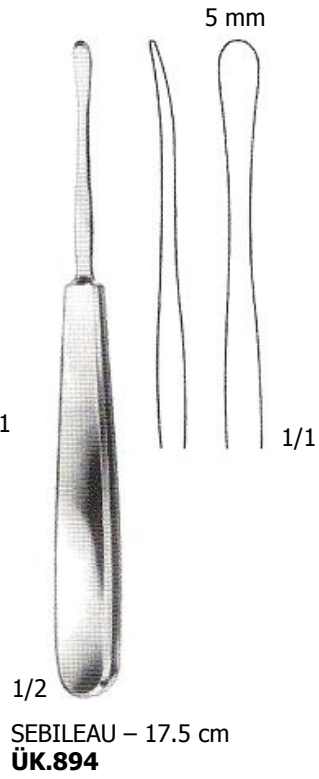
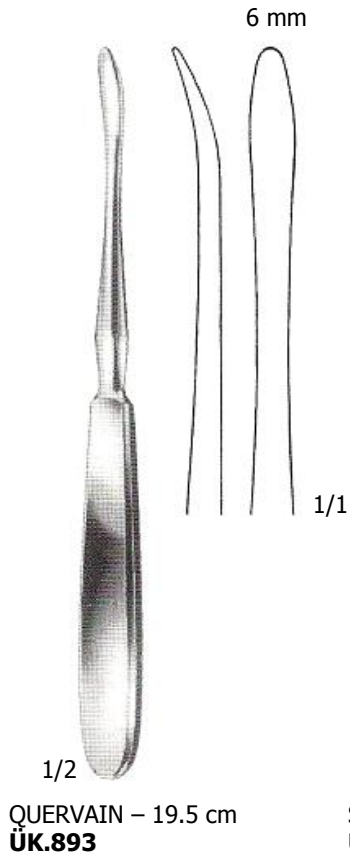

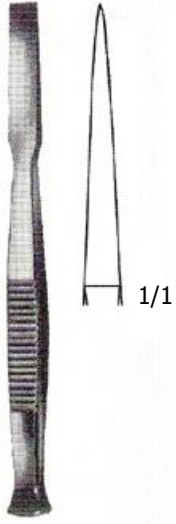

1/2
 14 cm
 4 mm **ÜK.902**
 6 mm **ÜK.903**
 8 mm **ÜK.904**
 10 mm **ÜK.905**
 12 mm **ÜK.906**

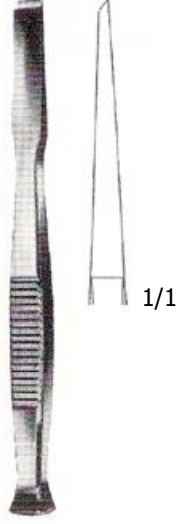

1/2
 14 cm
 4 mm **ÜK.907**
 6 mm **ÜK.908**
 8 mm **ÜK.909**
 10 mm **ÜK.910**
 12 mm **ÜK.911**



1/2
 PARTSCH – 14 cm
 3 mm **ÜK.912**
 4 mm **ÜK.913**
 5 mm **ÜK.914**
 6 mm **ÜK.915**



1/2
 PARTSCH – 14 cm
 3 mm **ÜK.916**
 4 mm **ÜK.917**
 5 mm **ÜK.918**
 6 mm **ÜK.919**

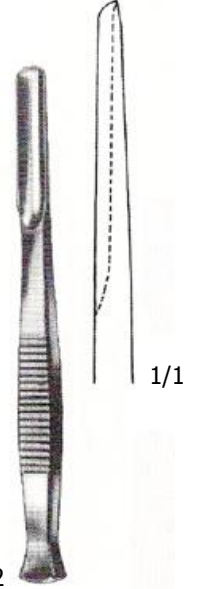

1/2
 14 cm
 4 mm **ÜK.920**
 6 mm **ÜK.921**
 8 mm **ÜK.922**
 10 mm **ÜK.923**
 12 mm **ÜK.924**

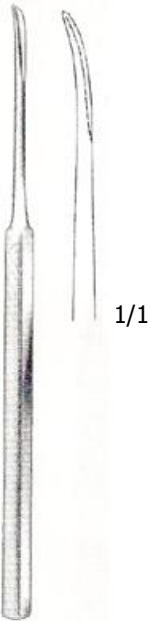

1/2
 THIES – 16 cm
 2 mm **ÜK.925**
 3 mm **ÜK.926**
 4 mm **ÜK.927**



1/2
 LUCAS – 16 cm
 3 mm **ÜK.928**
 5 mm **ÜK.929**



1/2
 LUCAS – 16 cm
 4 mm **ÜK.930**
 6 mm **ÜK.931**



1/2
 PASSOW – 16 cm
ÜK.932 – ÜK.933

Ø 5 mm
ÜK.932

Ø 3 mm
ÜK.933



1/2
 PASSOW – 12 cm
ÜK.934 – ÜK.935

3.5 mm
ÜK.934
 2.5 mm
ÜK.935

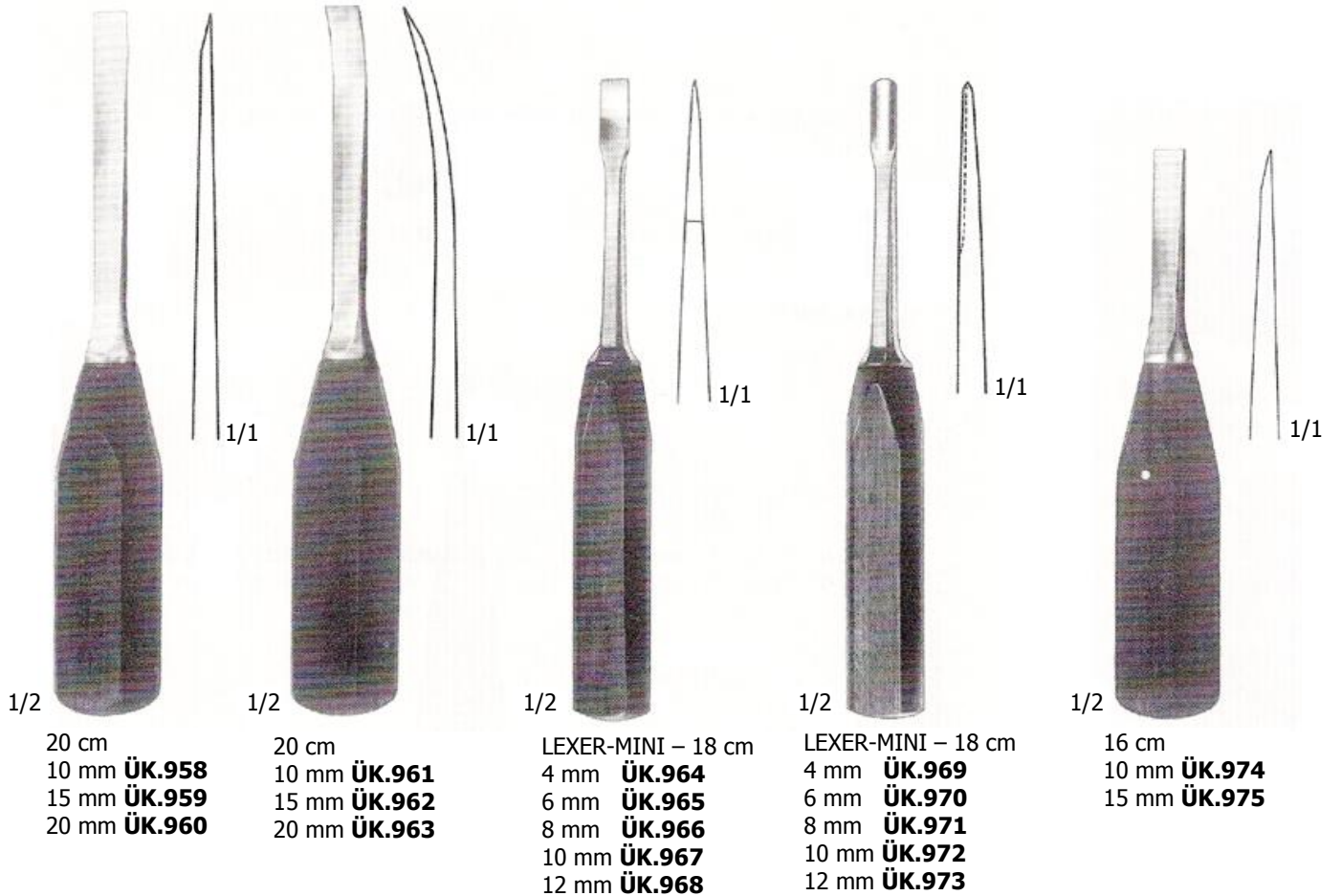
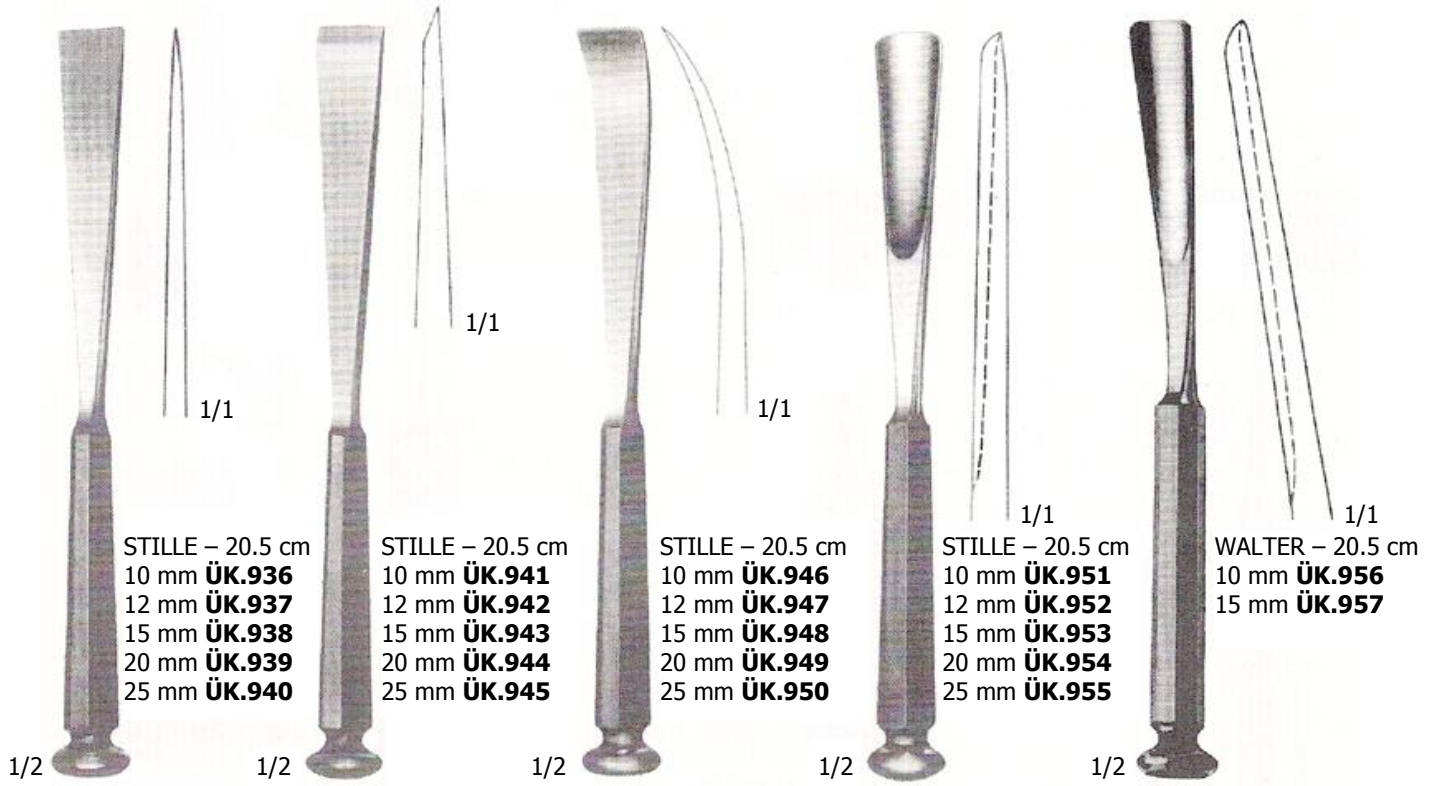

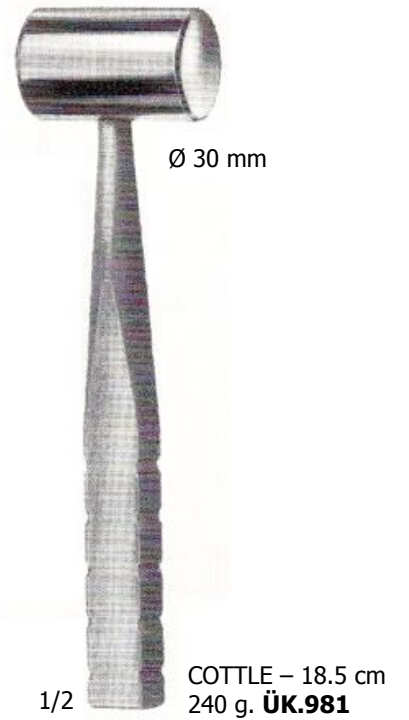
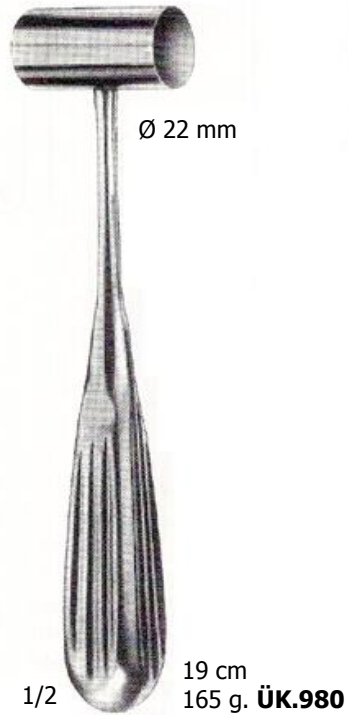
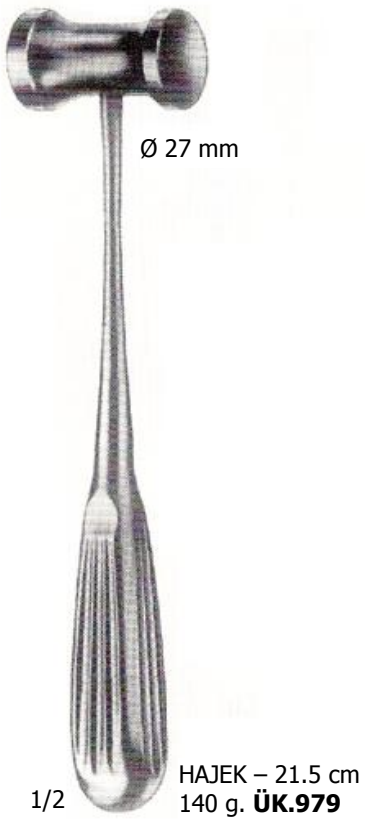
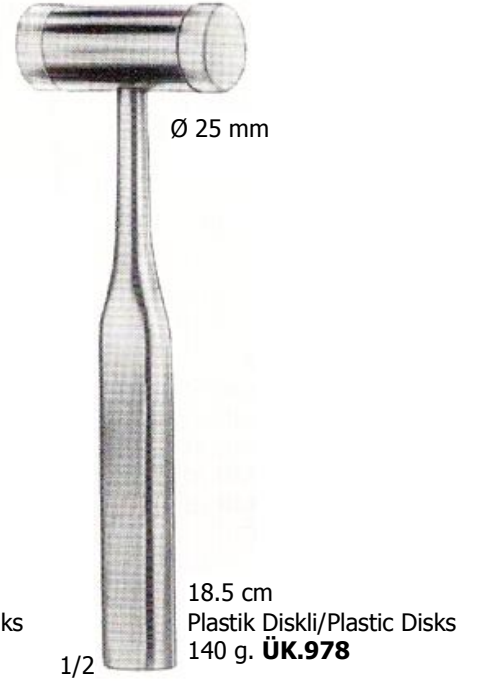
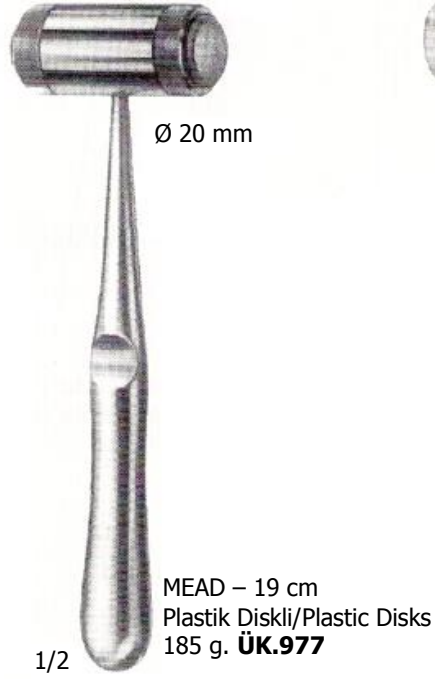

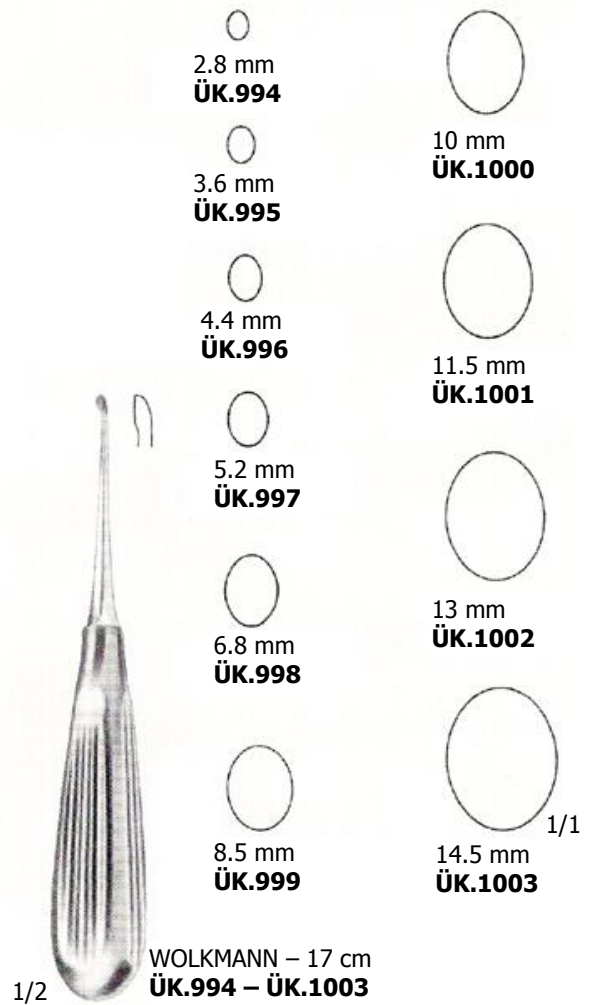
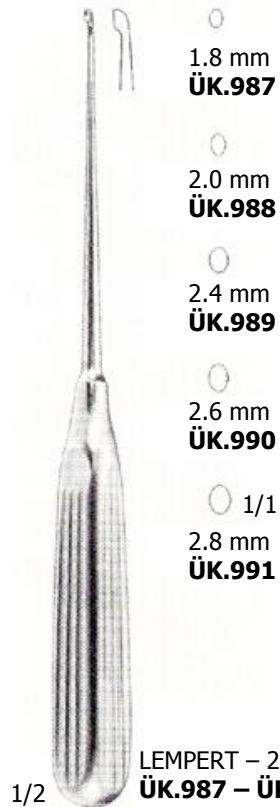
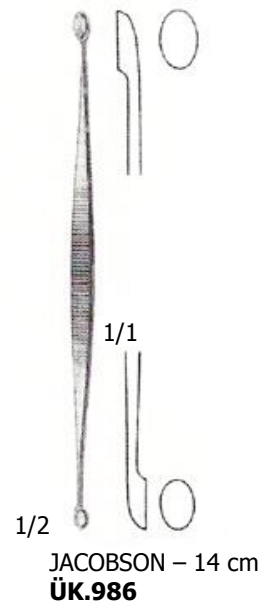
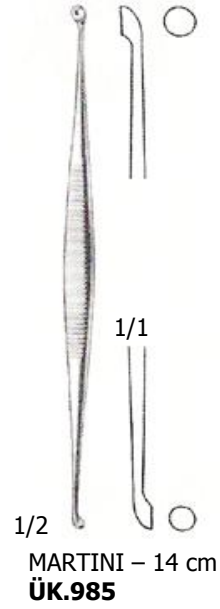
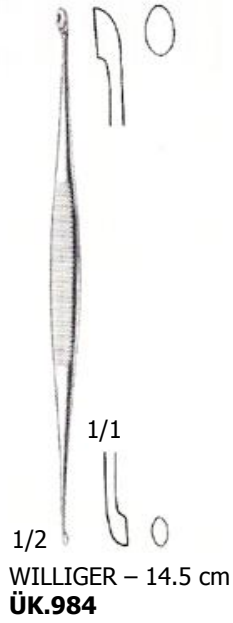
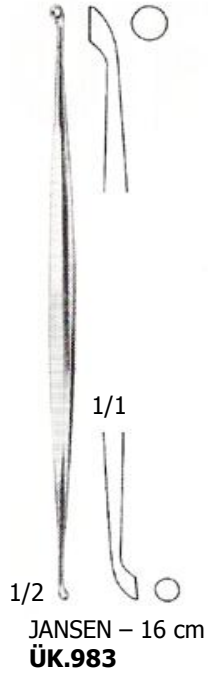

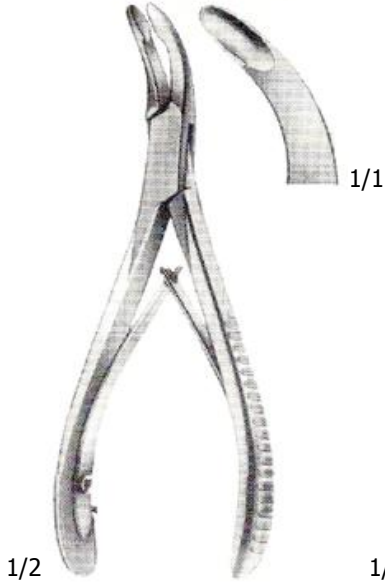

LUER – 15.5 cm
ÜK.1004

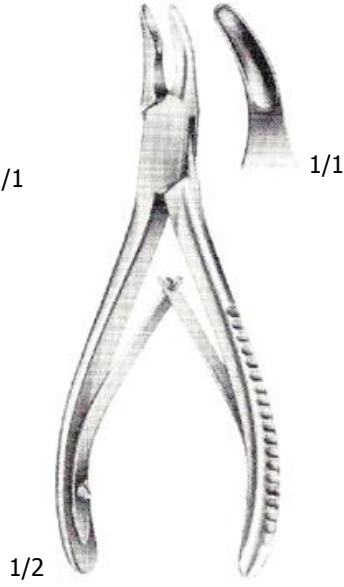

BLUMENTHAL – 15.5 cm
ÜK.1005

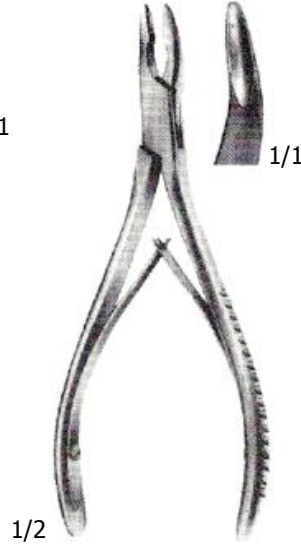

LUER-FRIEDMANN
15.5 cm **ÜK.1006**

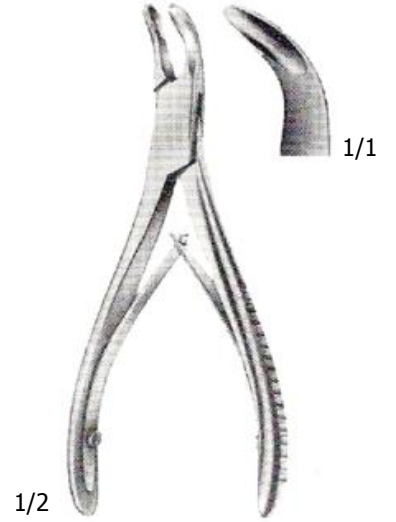

14 cm
ÜK.1007

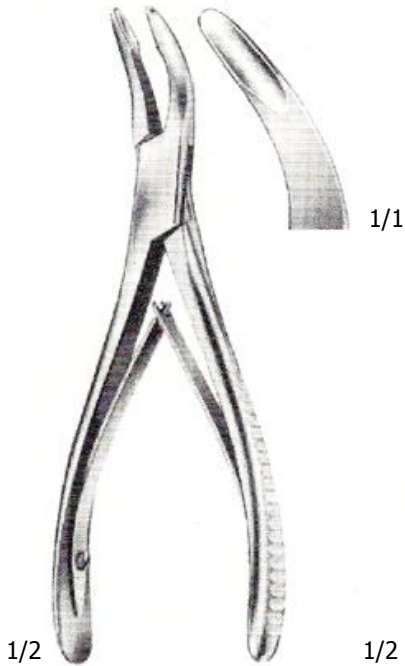

JANSEN – 17.5 cm
ÜK.1008

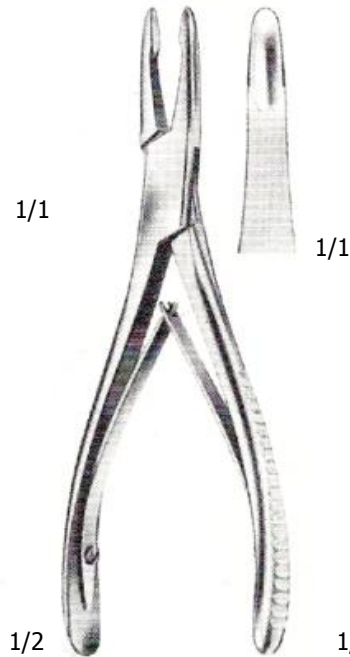

JANSEN – 17.5 cm
ÜK.1009

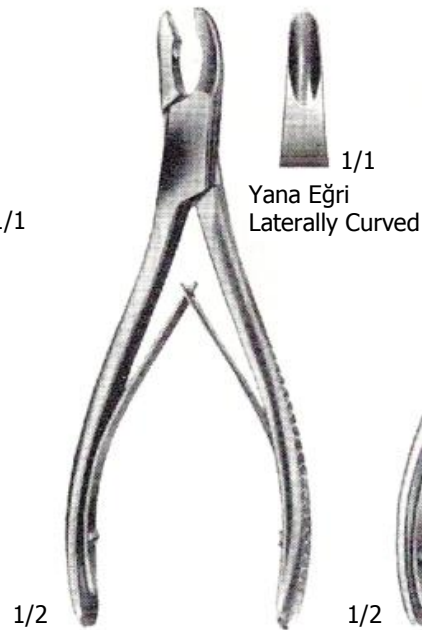

HAKANSSON – 17 cm
ÜK.1010

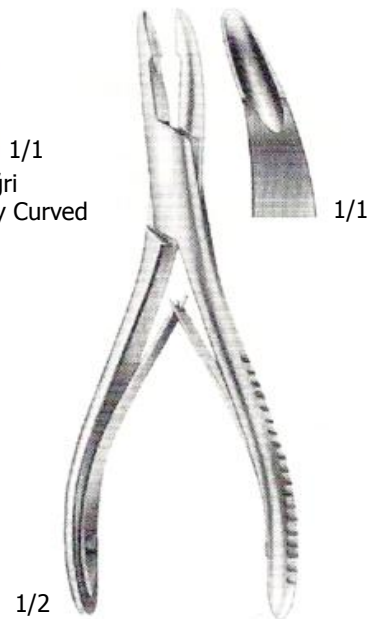

MEAD – 16.5 cm
ÜK.1011



1/2

LEMPERT – 20 cm
ÜK.1012

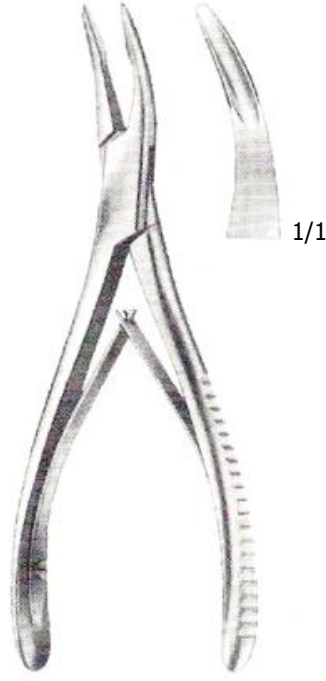

1/2

BEYER – 18 cm
ÜK.1013

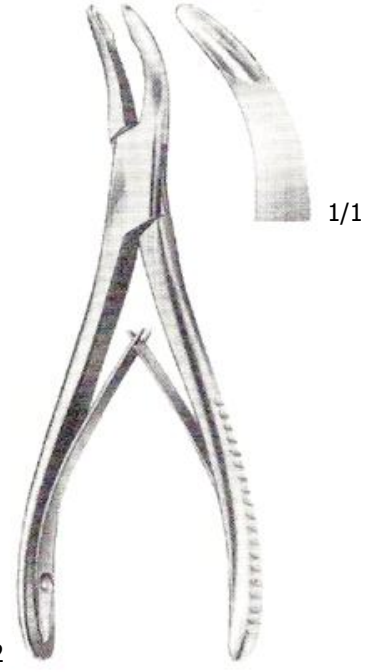

1/2

BANE-HARTMANN – 17.5 cm
ÜK.1014

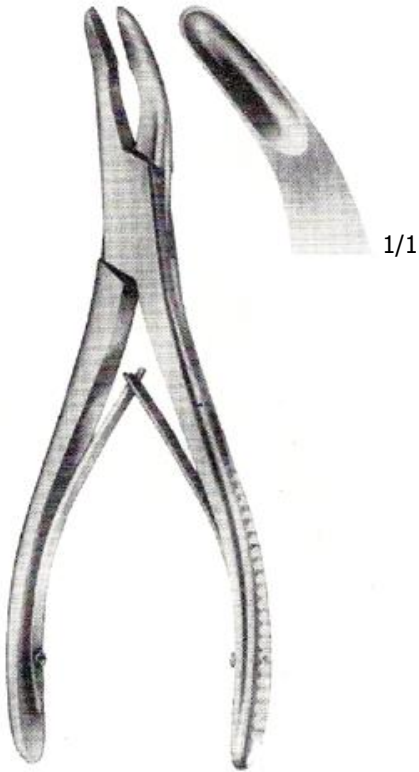

1/2

OLIVECRONA – 20.5 cm
ÜK.1015



1/2

LEMPERT – 20 cm
ÜK.1016

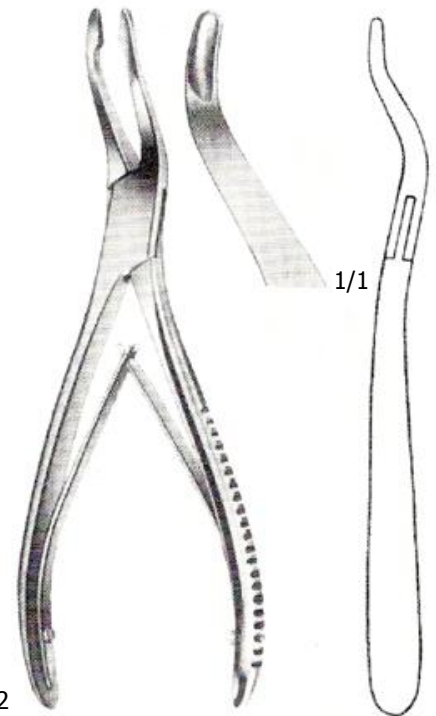

1/2

JANSEN – 19 cm
ÜK.1017

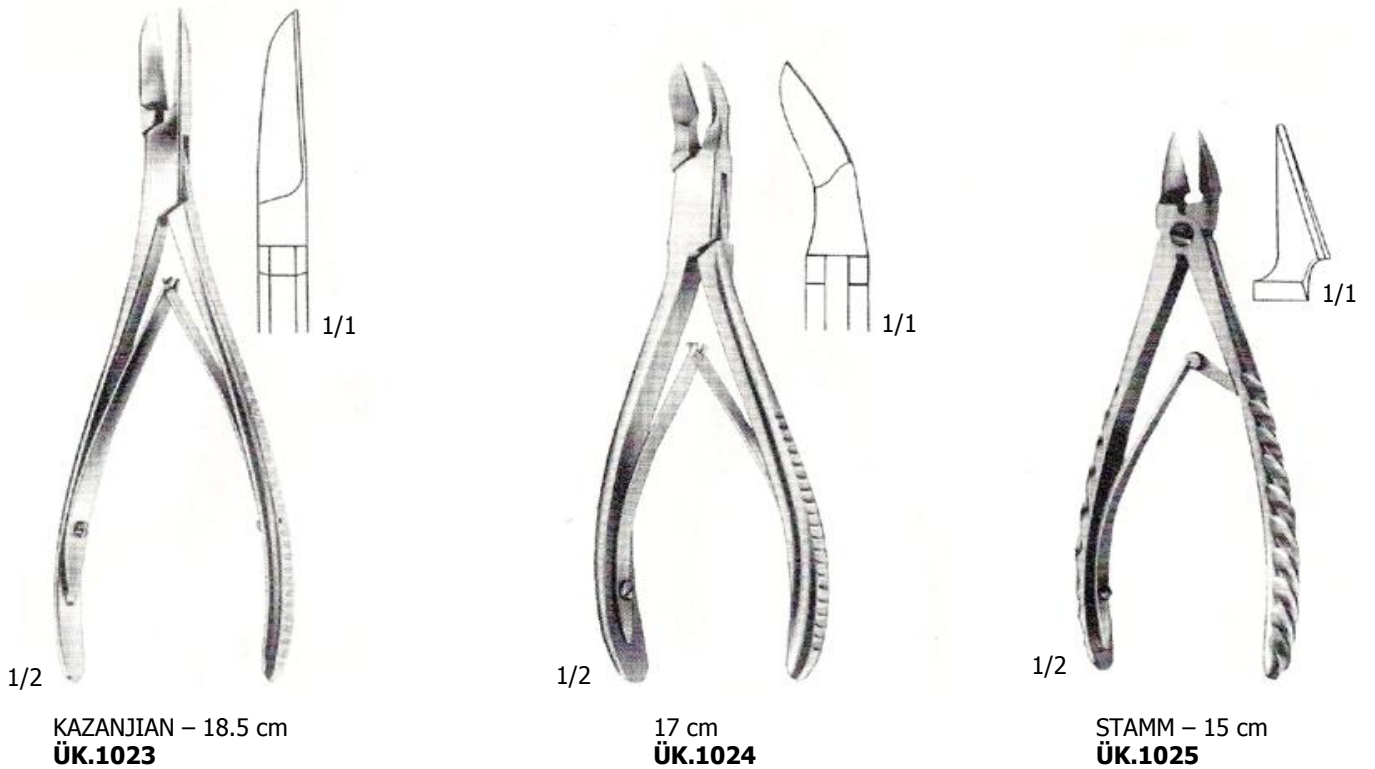
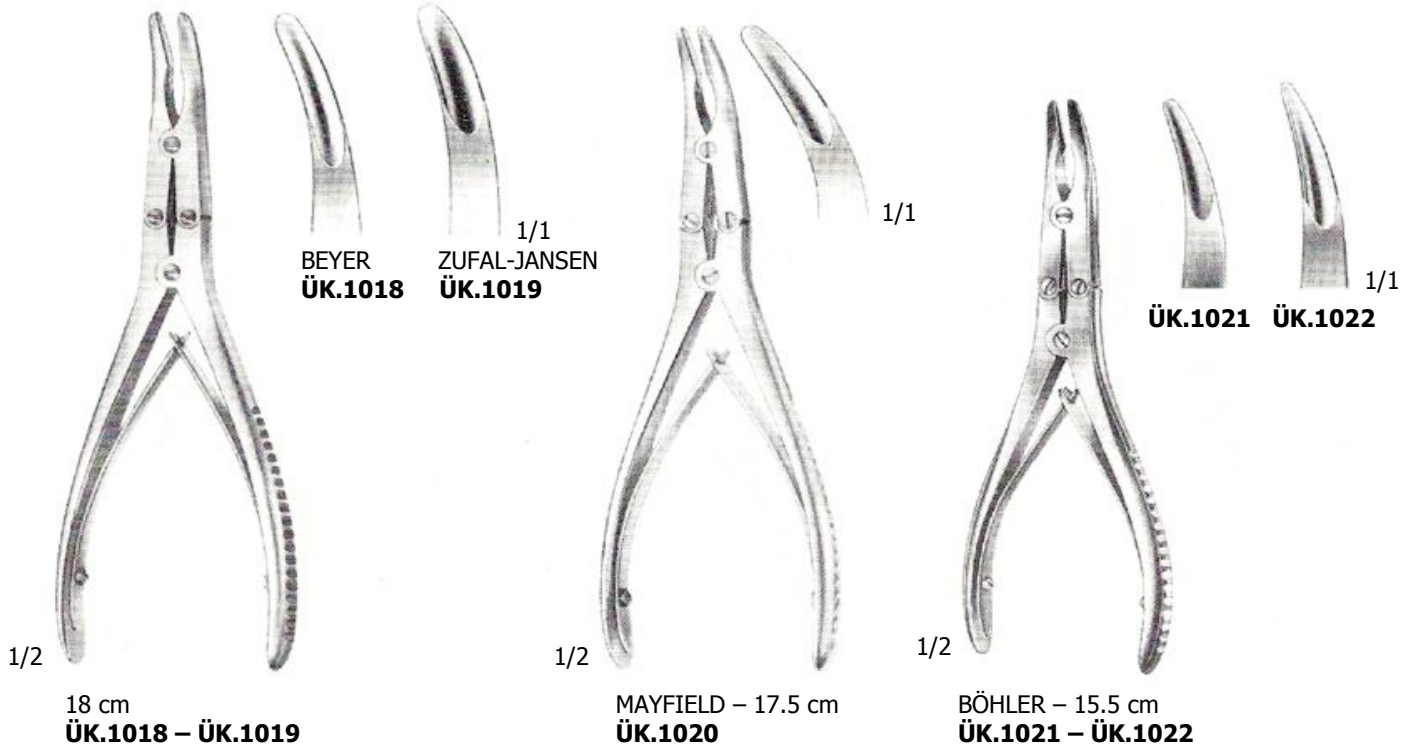

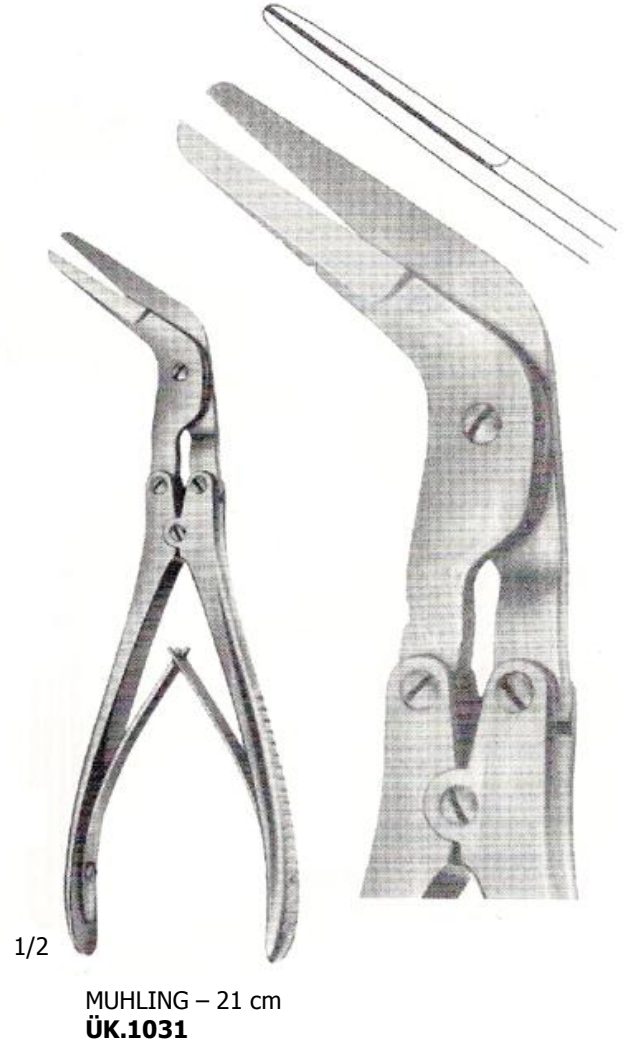
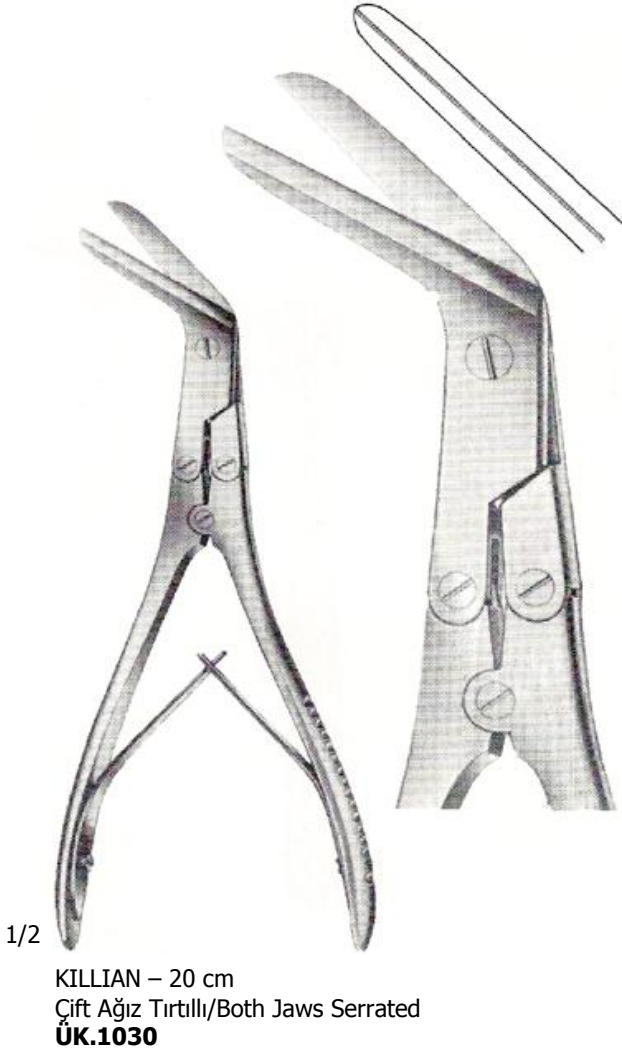
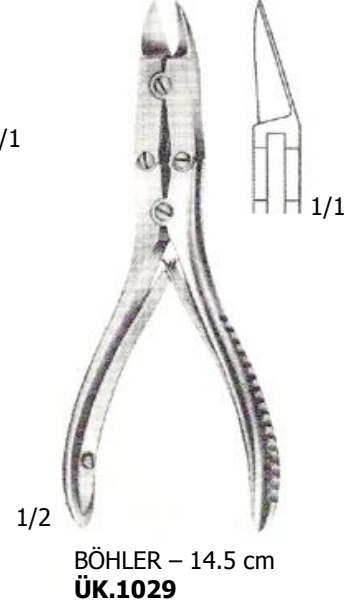
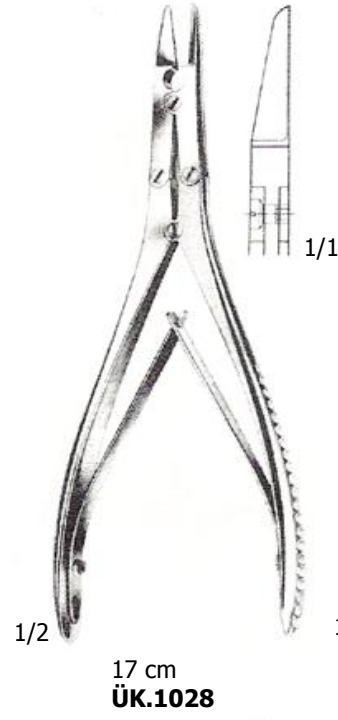
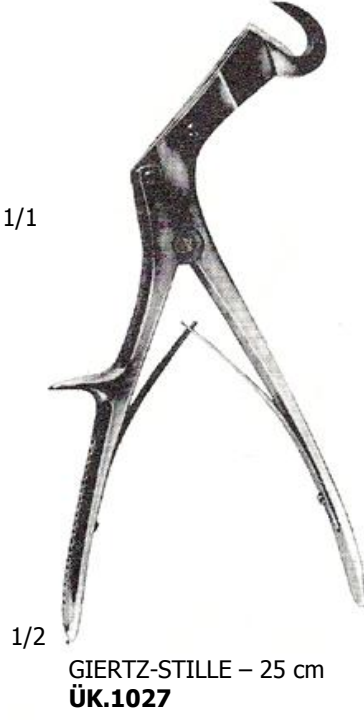



1/2

OBWEGESER
19,5 cm
ÜK.1032



OBWEGESER
15,5 cm
ÜK.1033



KELSEY
17 cm
ÜK.1034



1/1

SANDERS-BROWN
30 cm
ÜK.1035



1/1

SANDERS-BROWN
29 cm
ÜK.1036

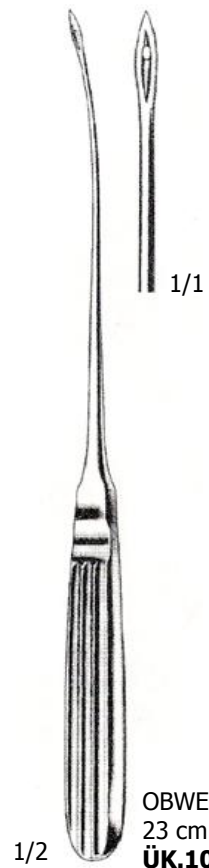

1/1

1/2

OBWEGESER
23 cm
ÜK.1037

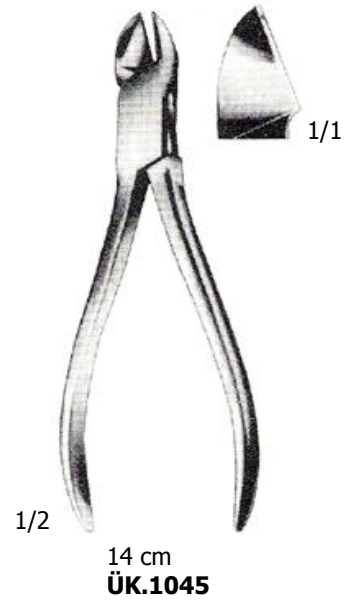
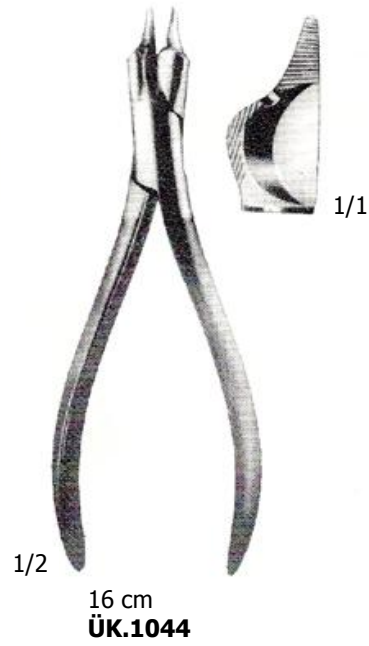
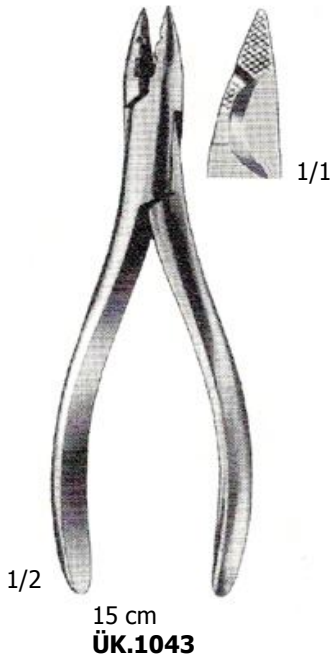
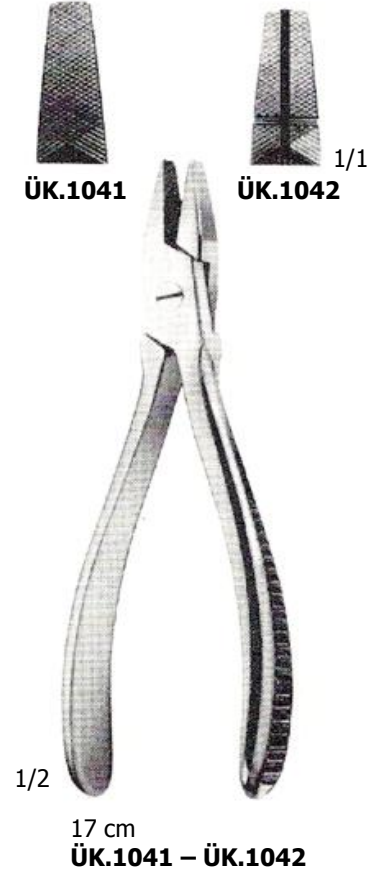
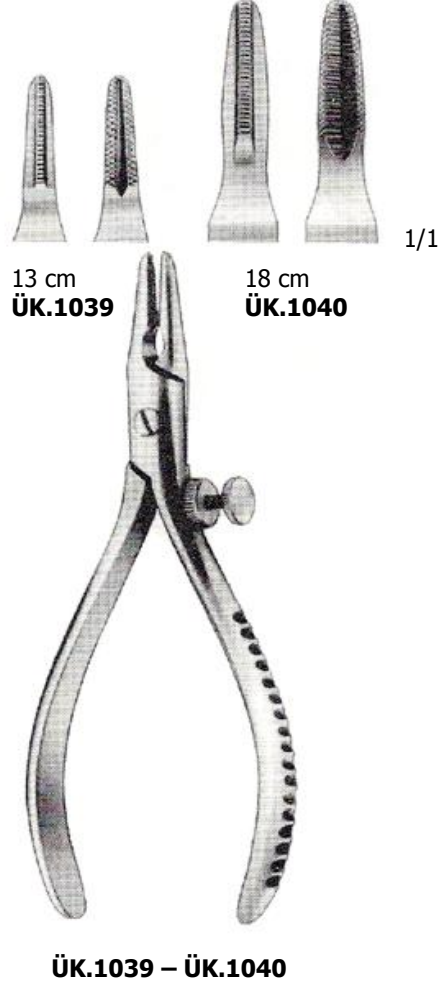

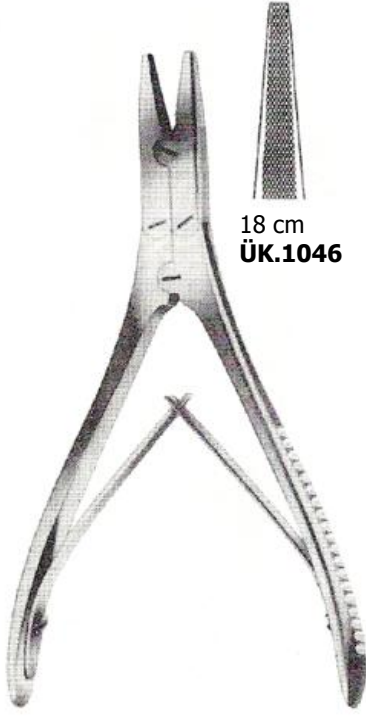

18 cm
ÜK.1046



14.5 cm
ÜK.1047



18 cm
ÜK.1048



18 cm
ÜK.1049



1/1

Ø 2.0 mm Yumuşak Tel İçin
Ø 2.0 mm For Soft Wire
Ø 1.6 mm Sert Tel İçin
Ø 1.6 mm For Hard Wire

1/2

REILL – 17.5 cm
ÜK.1050

ÜK.1046 – ÜK.1049

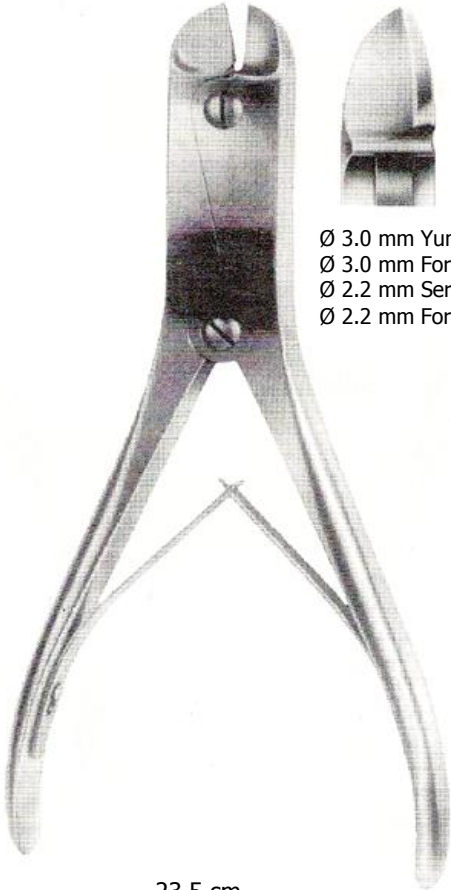

1/1

Ø 3.0 mm Yumuşak Tel İçin
Ø 3.0 mm For Soft Wire
Ø 2.2 mm Sert Tel İçin
Ø 2.2 mm For Hard Wire

1/2

23.5 cm
ÜK.1051

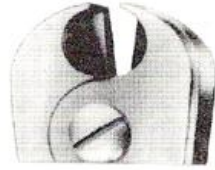
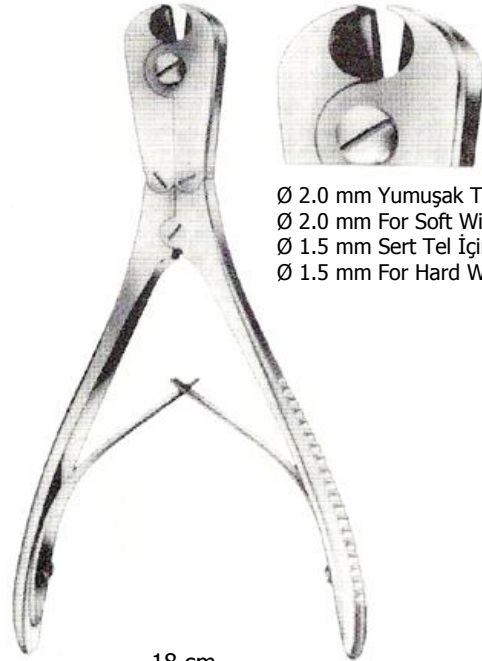

1/1

Ø 2.0 mm Yumuşak Tel İçin
Ø 2.0 mm For Soft Wire
Ø 1.5 mm Sert Tel İçin
Ø 1.5 mm For Hard Wire

1/2

18 cm
ÜK.1052

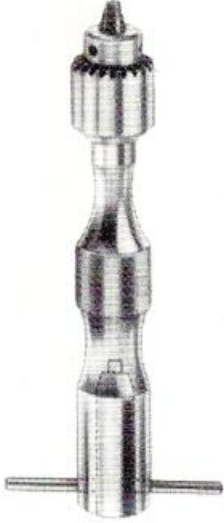

14 cm
Ø 4.5 mm Delme Başlığı
Ø 4.5 mm Drilling Chuck
ÜK.1053
Anahtarı ile/With key ÜK.1055

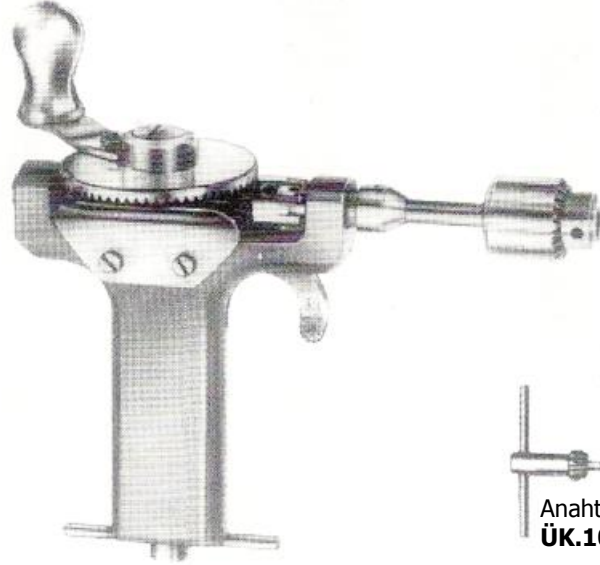

BUNNEL – 16 cm
Sadece El Matkabı/Hand Drill Only
ÜK.1054
Anahtarı ile/With key ÜK.1055

Anahtar/Key
ÜK.1055



7 cm
ÜK.1056 7 cm
ÜK.1057 7 cm
ÜK.1058

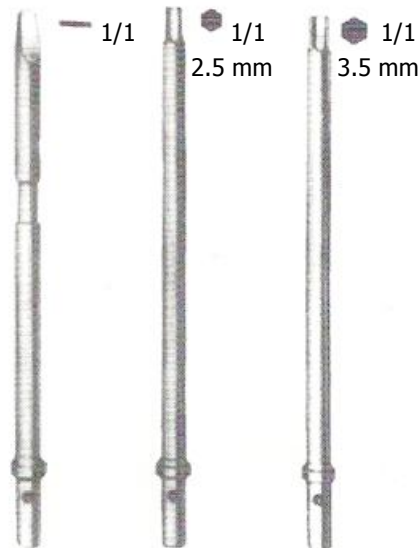

7 cm
ÜK.1059 7 cm
ÜK.1060 7 cm
ÜK.1061



8 cm
ÜK.1062 18 cm
ÜK.1063



İzolesiz
Non-Insulated

16 cm
0.7 mm **ÜK.1064**

18.5 cm
1.0 mm **ÜK.1065**

20 cm
1.0 mm **ÜK.1066**



İzoleli
Insulated

16 cm
0.9 mm **ÜK.1067**

20 cm
0.9 mm **ÜK.1068**



İzoleli
Insulated

16 cm
0.6 mm **ÜK.1069**
0.9 mm **ÜK.1070**

20 cm
0.9 mm **ÜK.1071**



İzolesiz
Non-Insulated

14 cm
0.3 mm **ÜK.1072**



İzolesiz
Non-Insulated





12 cm
ÜK.1073



İzolesiz
Non-Insulated

11.5 cm
ÜK.1074

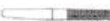

- 0.4 mm 
- 0.7 mm 
- 1.0 mm 
- 1.3 mm 



İzolesiz
Non-Insulated

16 cm
0.9 mm **ÜK.1075**

18.5 cm
0.9 mm **ÜK.1076**

20 cm
0.9 mm **ÜK.1077**



İzoleli
Insulated

İzolesiz
Non-Insulated

16 cm
İzolesiz/Non-Insulated
0.9 mm **ÜK.1078**

18.5 cm
İzoleli/Insulated
0.9 mm **ÜK.1079**



İzoleli
Insulated

17.5 cm
0.4 mm **ÜK.1080**
0.7 mm **ÜK.1081**
1.0 mm **ÜK.1082**
1.3 mm **ÜK.1083**

19.5 cm
0.4 mm **ÜK.1084**
0.7 mm **ÜK.1085**
1.0 mm **ÜK.1086**
1.3 mm **ÜK.1087**

21.5 cm
0.4 mm **ÜK.1088**
0.7 mm **ÜK.1089**
1.0 mm **ÜK.1090**
1.3 mm **ÜK.1091**

23.5 cm
0.4 mm **ÜK.1092**
0.7 mm **ÜK.1093**
1.0 mm **ÜK.1094**
1.3 mm **ÜK.1095**



21.5 cm
İzolesiz/Non-Insulated
1.0 mm **ÜK.1096**



21.5 cm
İzoleli/Insulated
1.0 mm **ÜK.1097**



Oval Kesme Elektrodu
Cutting Electrode
Boy/Length 30 mm
En/Wide 3.5 mm
ÜK.1098



Kesme Elektrodu, Hassas
Cutting Electrode, Delicate
25 mm
ÜK.1099



Bıçak Elektrod
Knife Electrode
25 mm
ÜK.1100



Bıçak Elektrod
Knife Electrode
18 mm
ÜK.1101



Açılı Kesme Elektrodu
Angled Cutting Electrode
Boy/Length 14 mm
En/Wide 1.8 mm
ÜK.1102



Plaka Elektrod
Plate Electrode
ÜK.1103



Halkalı Elektrod
Loop Electrode
Ø 10 mm
Tel/Wire Ø 3 mm
ÜK.1104



Halkalı Elektrod
Loop Electrode
Ø 15 mm
ÜK.1105



Açılı Halkalı Elektrod
Angled Loop Electrode
Ø 8 mm
ÜK.1106



İğne Elektrod
Needle Electrode
25 cm
Ø 0.3 mm **ÜK.1107**
Ø 0.5 mm **ÜK.1108**
Ø 0.7 mm **ÜK.1109**



Küresel Uçlu Elektrod
Ball Point Electrode
Ø 2.5 mm **ÜK.1110**
Ø 4.0 mm **ÜK.1111**
Ø 6.0 mm **ÜK.1112**

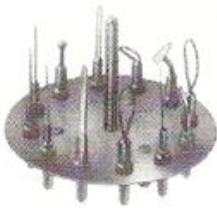

Komple/Complete **ÜK.1113**
Cerrahi Elektrodlar/Surgical Electrodes
Ø 4 mm

12 Elektrodluk Ray
Rack for 12 Electrodes



Elektrod Tutucusu
Electrode Holder
ÜK.1114

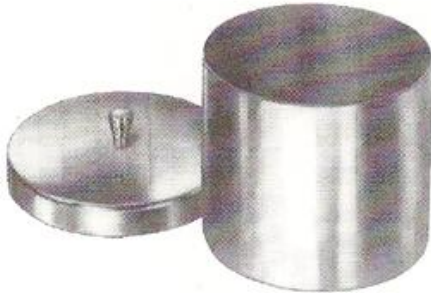

Kapaklı Elektrod Konteyneri
Container with lid for Electrodes
25 cm
ÜK.1116

Bipolar Kordon
Bipolar Cord
2 m.
ÜK.1115

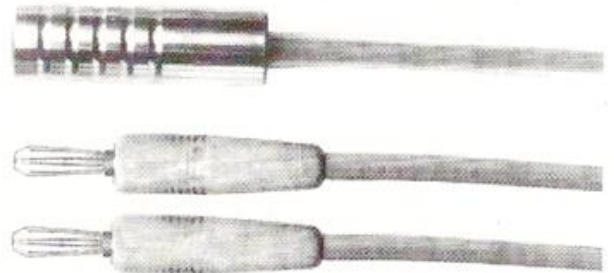

Komple/Complete **ÜK.1117**
ÜK.1113 – ÜK.1116



2. BÖLÜM

OTOLOJİ, KULAK MİKROCERRAHİ Otology, Ear Microsurgery



Ø 3.5 mm **ÜK.1119** Ø 5.0 mm **ÜK.1120** Ø 6.5 mm **ÜK.1121** Ø 8.0 mm **ÜK.1122**

HARTMANN
3'lü Set/Set Of 3 Rizes **ÜK.1118**
(ÜK.1119 – ÜK.1120 – ÜK.1121)



Ø 2 mm **ÜK.1124** Ø 3 mm **ÜK.1125** Ø 4 mm **ÜK.1126**

POLTZER
Çocuklar İçin / For Childen
3'lü Set/Set Of 3 Rizes **ÜK.1123**



Ø 4.0 mm **ÜK.1128** Ø 5.5 mm **ÜK.1129** Ø 7.0 mm **ÜK.1130**

TOYNBEE
3'lü Set/Set Of 3 Rizes **ÜK.1127**



Ø 1.8 mm **ÜK.1131** Ø 3.2 mm **ÜK.1132** Ø 4.6 mm **ÜK.1133**

HARTMANN
Çocuklar İçin / For Childen
ÜK.1131 – ÜK.1133





Ø 4.2 mm **ÜK.1135** Ø 5.2 mm **ÜK.1136** Ø 6.2 mm **ÜK.1137** Ø 7.2 mm **ÜK.1138**

BOUCHERON
4'lü Set/Set Of 4 Rizes **ÜK.1134**



Ø 8 mm **ÜK.1139** Ø 9 mm **ÜK.1140**

HARTMANN
İzoleli/Insulated
ÜK.1139 – ÜK.1140

5.5 x 6.5 mm
ÜK.1141
6.5 x 7.5 mm
ÜK.1142
7.5 x 8.5 mm
ÜK.1143
8.5 x 9.5 mm
ÜK.1144
9.5 x 10.5 mm
ÜK.1145
10.5 x 11.5 mm
ÜK.1146

ZÖLLNER
İzoleli/Insulated
ÜK.1141 – ÜK.1146

3.3 x 4.0 mm
ÜK.1148
4.0 x 5.4 mm
ÜK.1149
5.0 x 7.3 mm
ÜK.1150
6.0 x 8.3 mm
ÜK.1151
7.3 x 9.7 mm
ÜK.1152

SHEA
İzoleli/Insulated
5'li Set/Set Of 5 Rizes **ÜK.1147**

Ø 3.2 mm
ÜK.1154
Ø 5.0 mm
ÜK.1155
Ø 5.5 mm
ÜK.1156
Ø 6.2 mm
ÜK.1157
Ø 6.6 mm
ÜK.1158
Ø 7.0 mm
ÜK.1159
Ø 7.2 mm
ÜK.1160
Ø 9.2 mm
ÜK.1161

TUMARKIN
İzoleli/Insulated
8'li Set/Set Of 8 Rizes **ÜK.1153**

Ø 3 mm
ÜK.1163
Ø 4 mm
ÜK.1164
Ø 5 mm
ÜK.1165
Ø 7 mm
ÜK.1166

HARTMANN
İzoleli/Insulated
ÜK.1163 – ÜK.1166

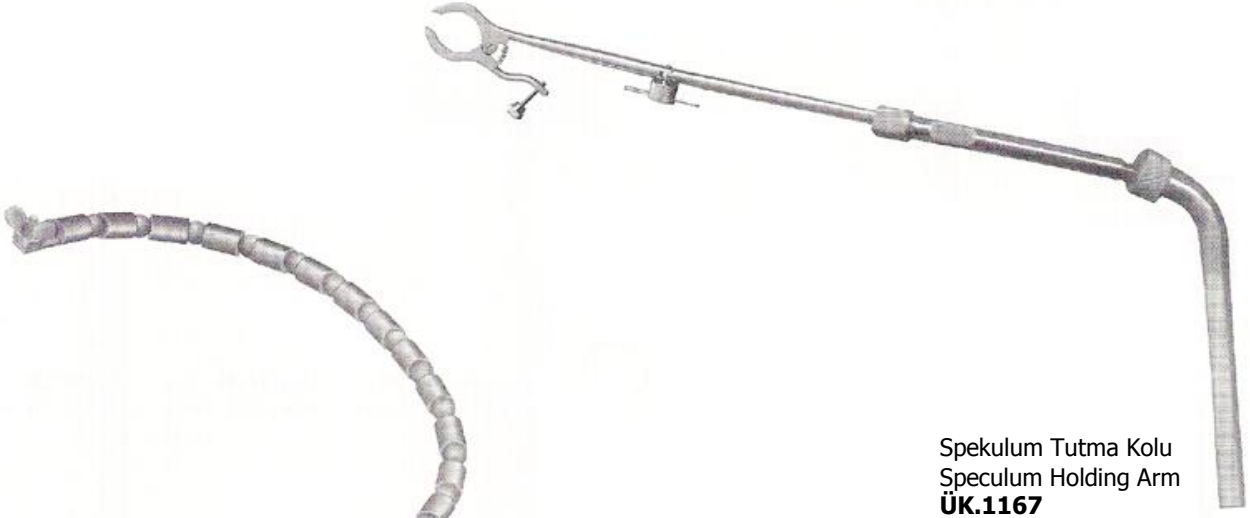

Spekulum Tutma Kolu
Spekulum Holding Arm
ÜK.1167



LEYLA
Spekulum Tutma Kolu, Bükülebilir
Spekulum Holding Arm, Flexible
ÜK.1168

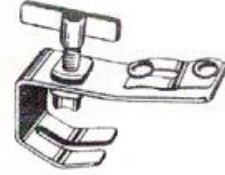

Tespit Elemanı
Fixation Base
ÜK.1169

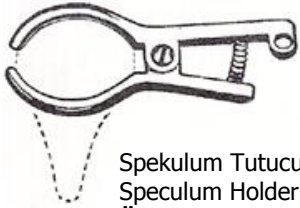

Spekulum Tutucu
Speculum Holder
ÜK.1170



YAŞARGİL
Yalnız Esnek Kol
Flexible Arm Only
ÜK.1171



1/2

BUCK – 9 cm
Tırtıllı Ağız/Serrated Jaws
ÜK.1172



1/2

QUIRE – 9 cm
ÜK.1173

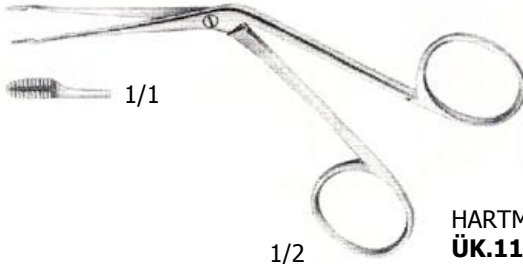

HARTMANN – 13.5 cm
ÜK.1174

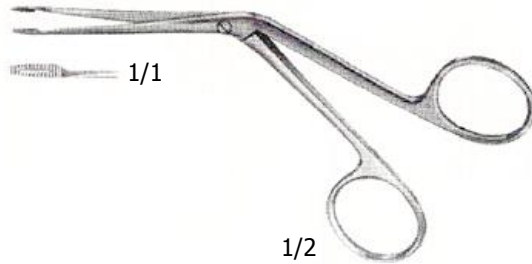

HARTMANN – 13.5 cm
ÜK.1175

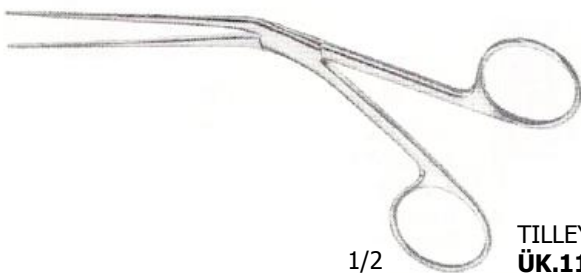

TILLEY – 14 cm
ÜK.1176

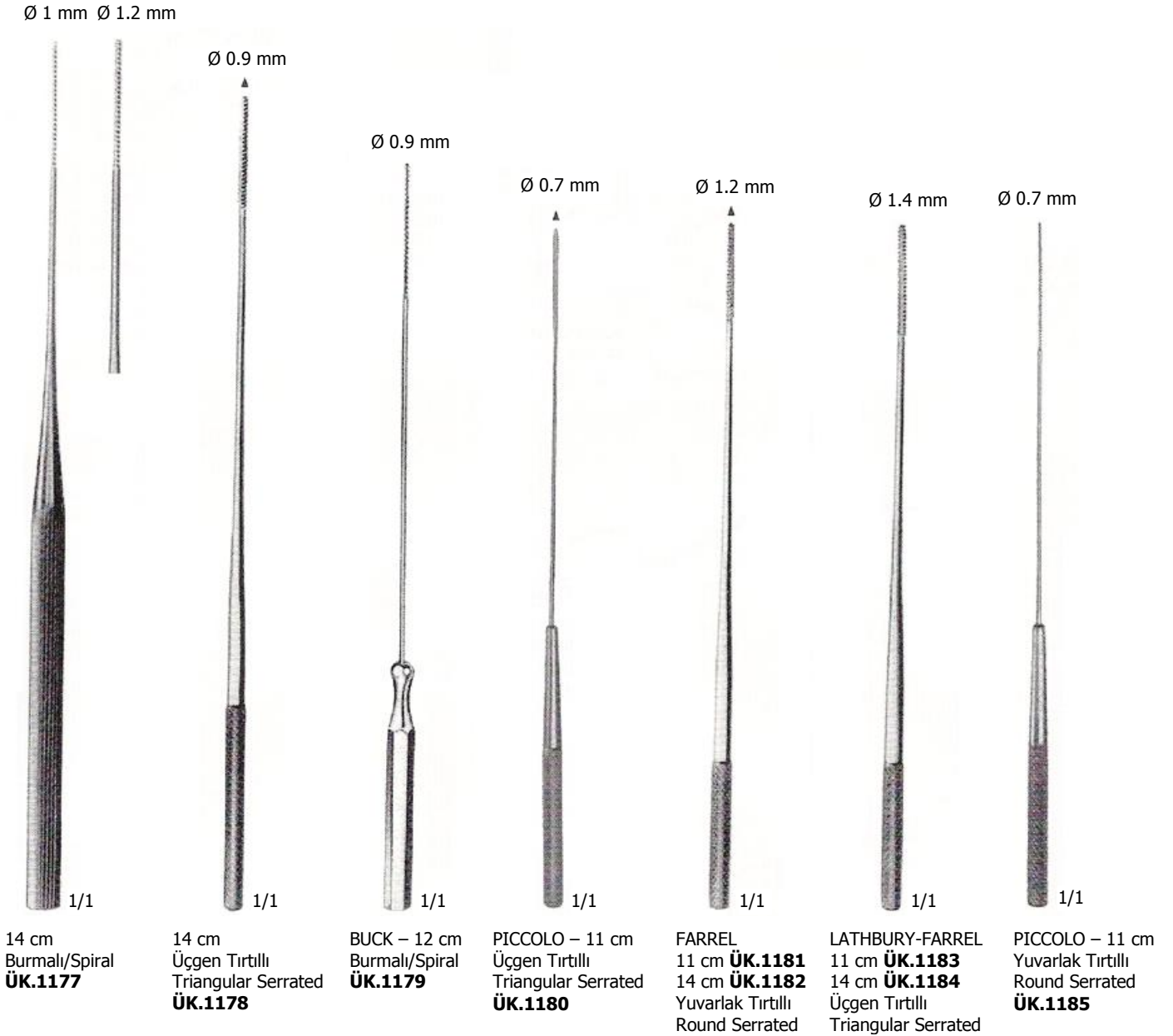

KABIERSKE

Komple/Complete **ÜK.1186**

(ÜK.1187 – ÜK.1192)

Metal Bağlayıcı **ÜK.1187**

Metal Mounting

Yalnız Lastik Üfleyici **ÜK.1188**

Rubber Bulb Only

Yalnız Yedek Cam **ÜK.1189**

Spare Glass Only

Uç/Tip **ÜK.1190**

Uç/Tip **ÜK.1191**

Uç/Tip **ÜK.1192**

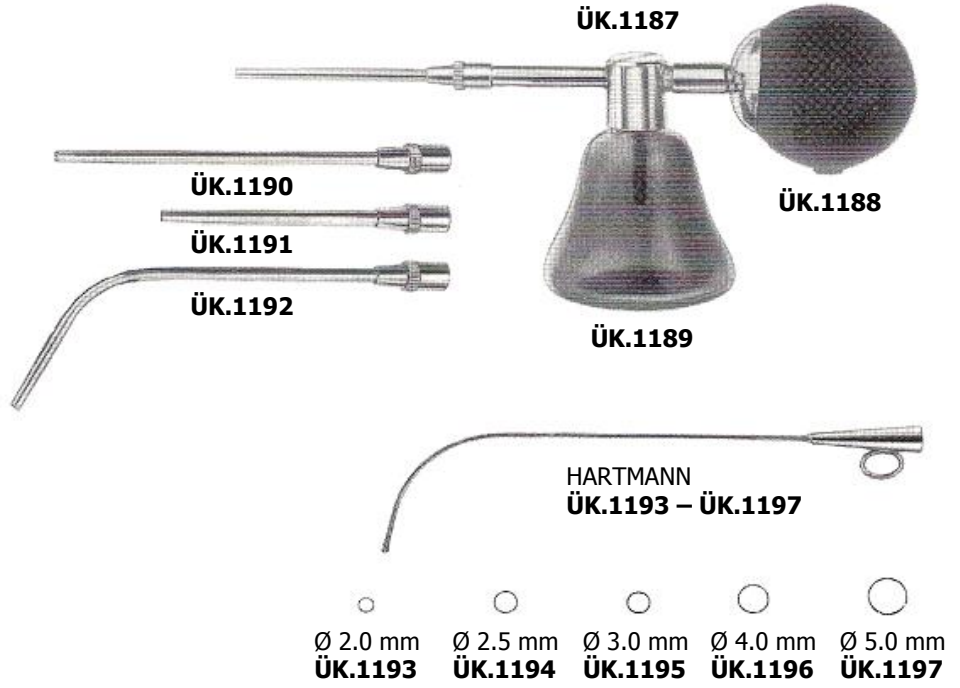

Metal Bağlayıcı
Metal Connector
ÜK.1202



Metal Uç/Metal Tip
Ø 18 mm **ÜK.1199**
Ø 21 mm **ÜK.1200**
Ø 23 mm **ÜK.1201**

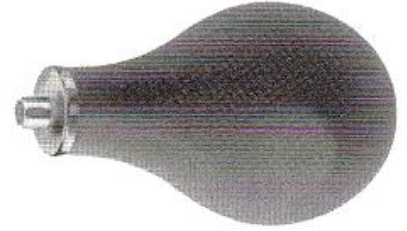

POLITZER
ÜK.1198



LUER-LOCK
ÜK.1209



LUER-LOCK
ÜK.1210



ÜK.1211

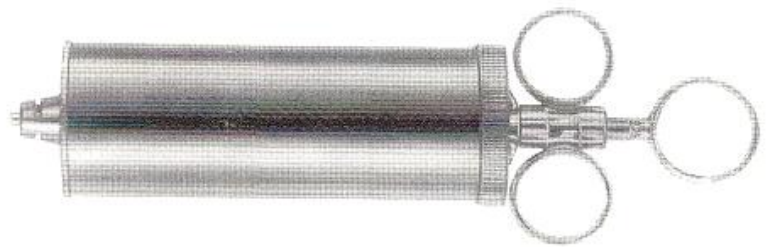

	Komple Complete	Yalnız Şırınga Syringe Only	Sivri Uç Tip Tapered	Yuvarlak Uç Tip Bulbous	Koruma Kalkanı Protection Shield
50 ml	ÜK.1203	ÜK.1206	ÜK.1209	ÜK.1210	ÜK.1211
75 ml	ÜK.1204	ÜK.1207			
100 ml	ÜK.1205	ÜK.1208			

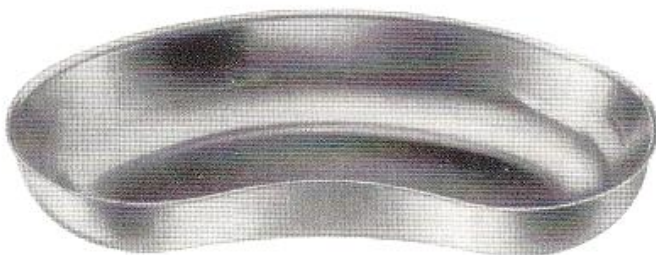

170 x 100 x 35 mm **ÜK.1212**
250 x 140 x 40 mm **ÜK.1213**
275 x 150 x 45 mm **ÜK.1214**

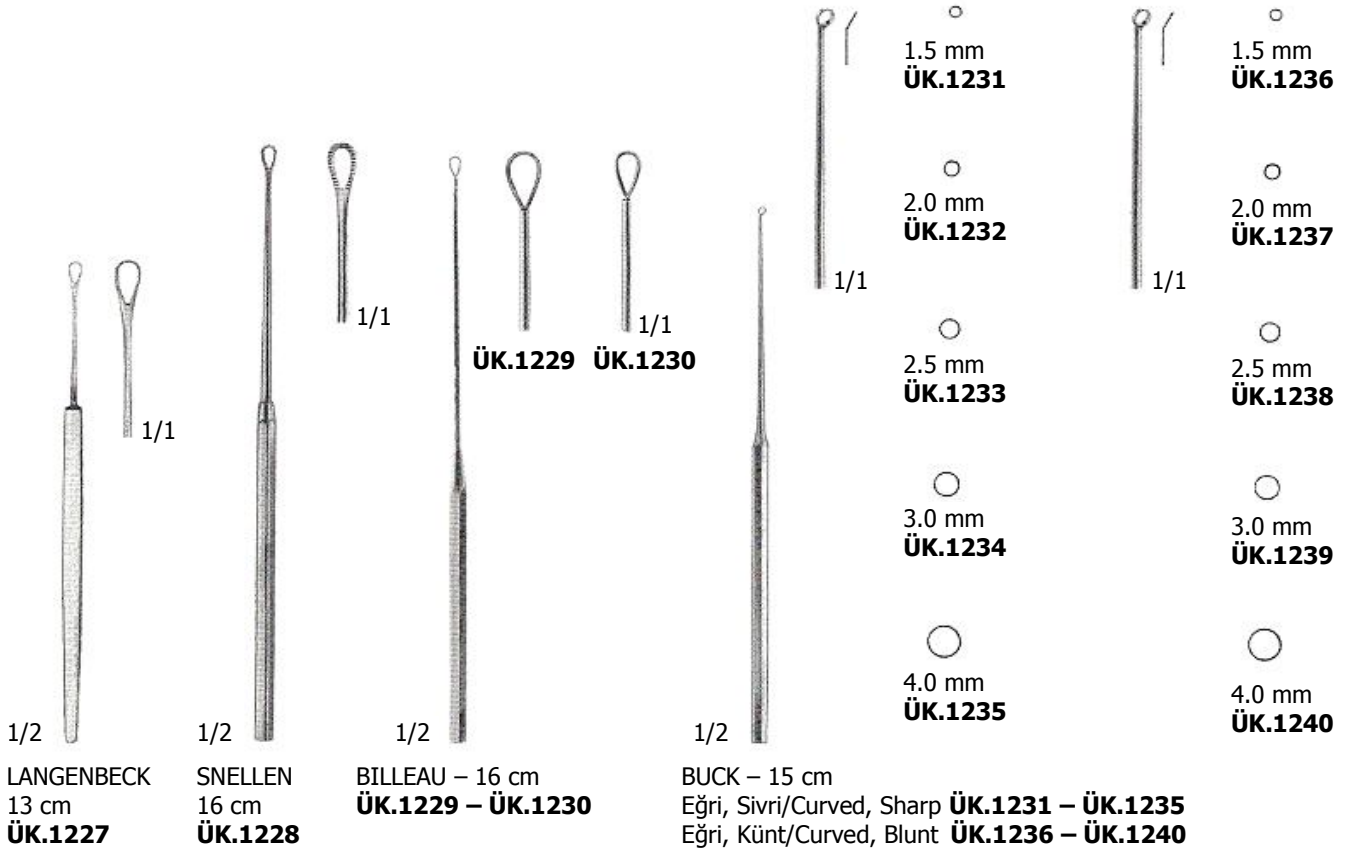
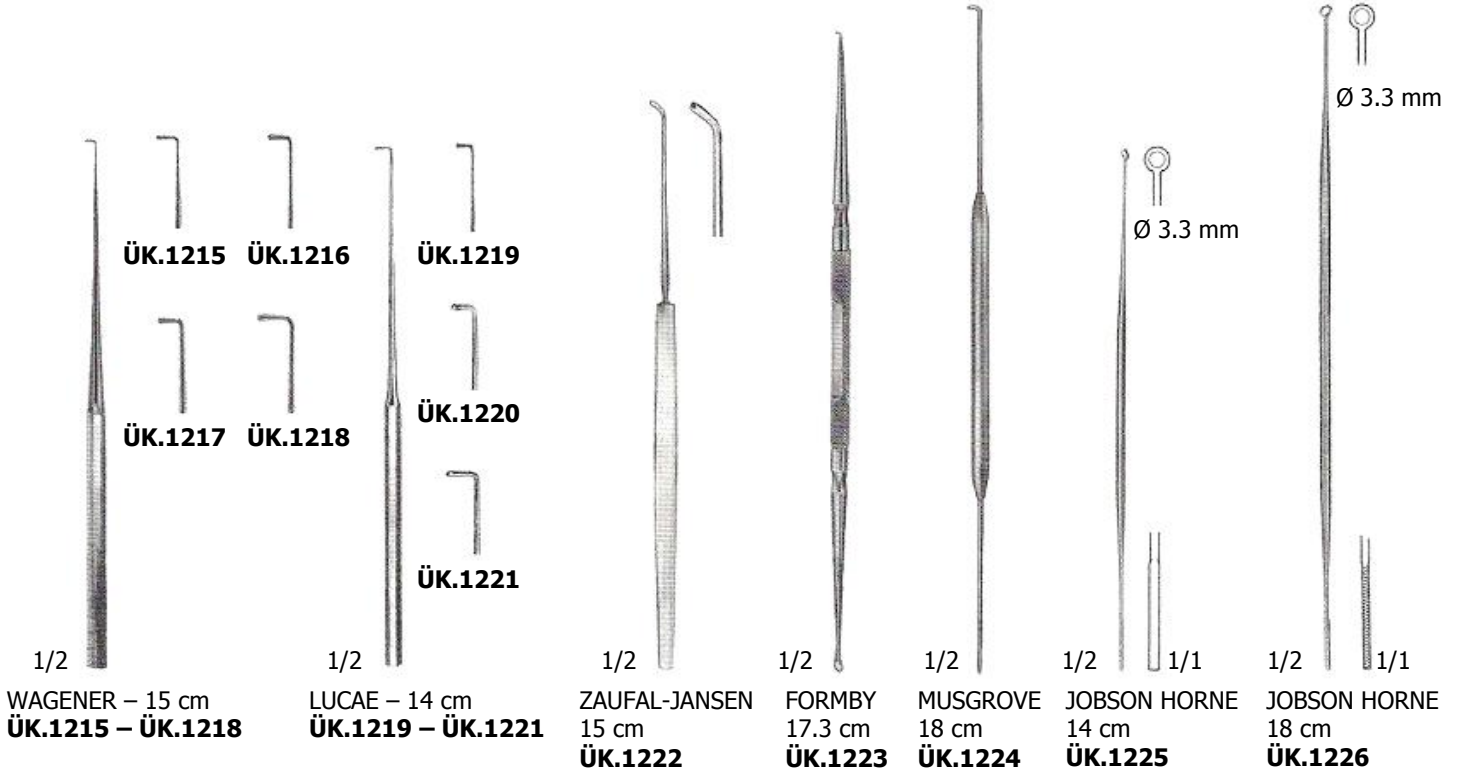

ÜK.1241



LUCAE
Çocuklar İçin/For Children
16 cm **ÜK.1241**
Yetişkinler İçin/For Adults
16 cm **ÜK.1242**
Çocuklar İçin/For Children
16 cm **ÜK.1243**

1/2



1/2



1/2

AGNEW
(POLITZER)
16 cm
ÜK.1245

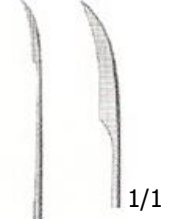

1/2

POLITZER
16 cm
ÜK.1246



1/2

KRAUSE – 16.3 cm
Hassas/Delicate
ÜK.1247



1/1

12'lik Paket
Package Of 12 Pcs
Ø 0.2 mm **ÜK.1248**



1/2

17 cm
Ayarlanabilir Blade
Adjustable Blade
Ø 0.2 mm **ÜK.1249**

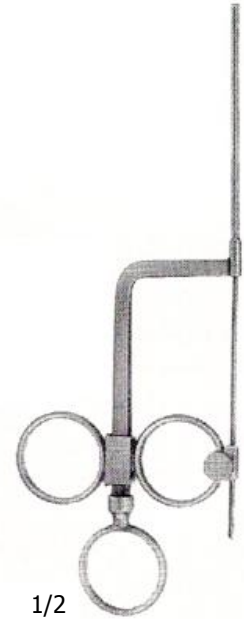



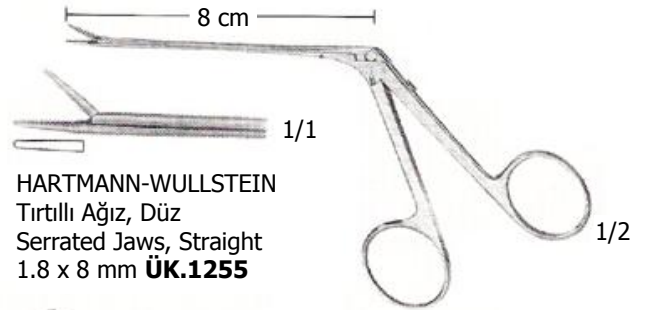
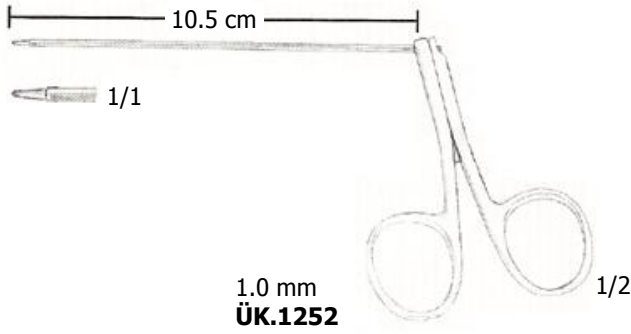
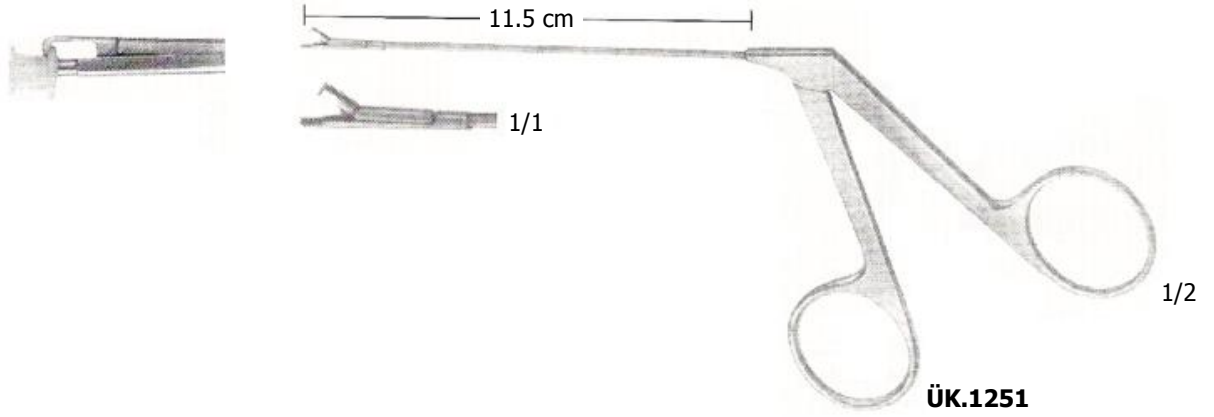

1/2

GLEGG – 16.5 cm
Telsiz/Without Wire
ÜK.1250



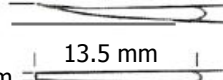

0.23 mm  RONIS – 15 cm
Düz Şaft/Straight Shaft
0.75 mm  **ÜK.1265**

0.9 mm  GOLDMAN – 15 cm
Düz Şaft/Straight Shaft
0.4 mm  **ÜK.1266**

1 mm  GOLDMAN – 15 cm
Düz Şaft/Straight Shaft
ÜK.1267

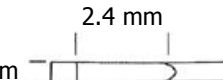

0.46 mm  HOUSE – 16.5 cm
Düz Şaft/Straight Shaft
ÜK.1268

 HUGHES – 16.5 cm
Düz Şaft/Straight Shaft
ÜK.1269



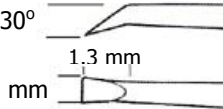

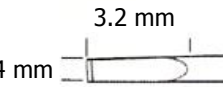
0.5 mm  GUILFORD – 14 cm
6° Şaft/Shaft
1.3 mm  **ÜK.1270**

0.76 mm  FARRIOR – 15 cm
30° Şaft/Shaft
ÜK.1271

0.4 mm  MCGEE – 16 cm
20° Şaft/Shaft
0.7 mm  **ÜK.1272**

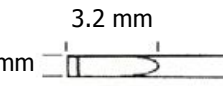
0.76 mm  GUILFORD – 14 cm
6° Şaft/Shaft
ÜK.1273

0.5 mm  HOUGH – 15 cm
10° Şaft/Shaft
0.15 mm  **ÜK.1274**

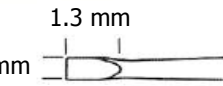
0.5 mm  GUILFORD – 14 cm
6° Şaft/Shaft
ÜK.1275

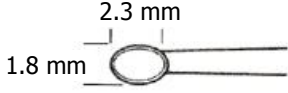

AUSTIN – 15 cm
10° Şaft/Shaft
ÜK.1276

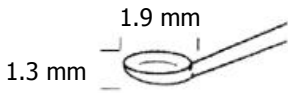

GUILFORD – 14 cm
Düz Şaft/Straight Shaft
ÜK.1277

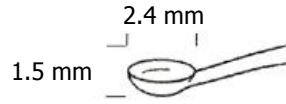

GUILFORD – 14 cm
Kazboynu Şaft
Gooseneck Shaft
ÜK.1278

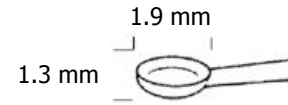

GUILFORD – 14 cm
Düz Şaft/Straight Shaft
ÜK.1279

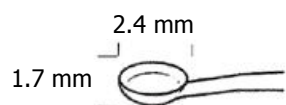

GUILFORD – 14 cm
Kazboynu Şaft
Gooseneck Shaft
ÜK.1280



GUILFORD – 14 cm
Düz Şaft/Straight Shaft
ÜK.1281

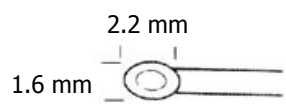

GOLDMAN – 15 cm
Düz Şaft/Straight Shaft
ÜK.1282

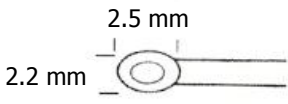

GOLDMAN – 15 cm
Düz Şaft/Straight Shaft
ÜK.1283

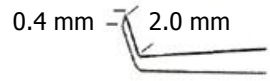

ANTOLI-CANDELA – 16.5 cm
Düz Şaft/Straight Shaft
ÜK.1284

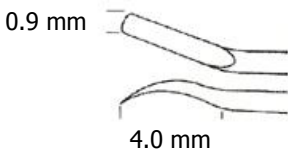

HOUGH – 15 cm
Düz Şaft/Straight Shaft
ÜK.1285

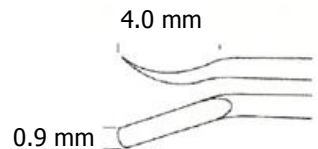

HOUGH – 15 cm
Düz Şaft/Straight Shaft
ÜK.1286



1.2 mm
1.0 mm
ANTOLI-CANDELA – 15 cm
10° Şaft/Shaft
ÜK.1287

2.0 mm
1.5 mm
ANTOLI-CANDELA – 15 cm
10° Şaft/Shaft
ÜK.1288

2.3 mm
1.8 mm
AUSTIN – 15 cm
10° Şaft/Shaft
ÜK.1289

1.2 mm
0.8 mm
RONIS – 13 cm
10° Şaft/Shaft
ÜK.1290

2.2 mm
1.7 mm
SHEA – 14.5 cm
10° Şaft/Shaft
ÜK.1291

2.8 mm
2.0 mm
RONIS – 13 cm
Açılı Şaft/Angled Shaft
ÜK.1292



1.2 mm
0.9 mm
ANTOLI-CANDELA – 15 cm
Düz Şaft/Straight Shaft
ÜK.1293

2.0 mm
1.5 mm
HOUGH – 15 cm
Düz Şaft/Straight Shaft
ÜK.1294

2.4 mm
1.7 mm
SCHEER – 17 cm
Düz Şaft/Straight Shaft
ÜK.1295

2.0 mm
1.8 mm
SCHEER – 17 cm
Düz Şaft/Straight Shaft
ÜK.1296

2.8 mm
HOUGH – 15 cm
Düz Şaft/Straight Shaft
ÜK.1297



2.0 mm 7.0 mm 15° ANTOLI-CANDELA – 16.5 cm
Düz Şaft/Straight Shaft
ÜK.1298

0.4 mm 0.5 mm LIPPY – 17 cm
Düz Şaft/Straight Shaft
ÜK.1299

1.4 mm 5.0 mm 10° ANTOLI-CANDELA – 16.5 cm
Düz Şaft/Straight Shaft
ÜK.1300

14 mm 15° GUILFORD – 14 cm
Düz Şaft/Straight Shaft
ÜK.1301

1.0 mm 11.9 mm 15° HOUSE-TYPE – 16.5 cm
Düz Şaft/Straight Shaft
ÜK.1302

0.5 mm 10 mm 15° RONIS – 15 cm
Düz Şaft/Straight Shaft
ÜK.1303

6 mm GUILFORD – 14 cm
Düz Şaft/Straight Shaft
ÜK.1304

12 mm GUILFORD – 14 cm
Düz Şaft/Straight Shaft
ÜK.1305

0.3 mm 2.7 mm ANTOLI-CANDELA – 16.5 cm
Düz Şaft/Straight Shaft
ÜK.1306

14.2 mm 10° SHEA – 17 cm
Düz Şaft/Straight Shaft
Sağ/Right **ÜK.1307**
Sol/Left **ÜK.1308**



2.5 mm 2.4 mm RICHARDS – 18 cm
Düz Şaft/Straight Shaft
ÜK.1309

2.7 mm 2.3 mm HOUSE-TYPE – 18 cm
Düz Şaft/Straight Shaft
ÜK.1310



0.5 mm 0.8 mm RUGGLES – 17 cm
12° Şaft/Shaft
ÜK.1311



AUSTIN – 16.5 cm
40° Şaft/Shaft
ÜK.1312



SCHUKNECHT – 15.5 cm
20° Şaft/Shaft
ÜK.1313

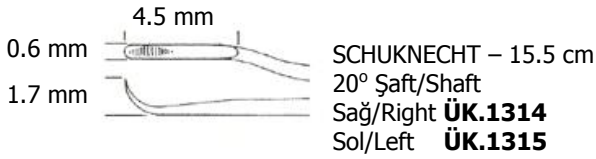

SCHUKNECHT – 15.5 cm
20° Şaft/Shaft
Sağ/Right **ÜK.1314**
Sol/Left **ÜK.1315**



AUSTIN – 16.5 cm
10° Şaft/Shaft
ÜK.1316



ANTOLI-CANDELA – 16.5 cm
20° Şaft/Shaft
ÜK.1317



ROSEN – 16 cm
Düz Şaft/Straight Shaft
ÜK.1318



GINSBERG – 15 cm
Düz Şaft/Straight Shaft
ÜK.1319



AUSTIN – 16.5 cm
Düz Şaft/Straight Shaft
ÜK.1320



SCHEER – 16 cm
Düz Şaft/Straight Shaft
ÜK.1321



PLESTER – 16 cm
Düz Şaft/Straight Shaft
ÜK.1322



MCGEE – 15.5 cm
Düz Şaft/Straight Shaft
ÜK.1323



GUILDFORD – 14 cm
Düz Şaft/Straight Shaft
ÜK.1324



GUILDFORD – 14 cm
Düz Şaft/Straight Shaft
ÜK.1325



AUSTIN – 16.5 cm
Düz Şaft/Straight Shaft
ÜK.1326



1.0 mm  25° SEA – 17.5 cm
Düz Şaft/Straight Shaft
ÜK.1327

1.0 mm  45° SEA – 17.5 cm
Düz Şaft/Straight Shaft
ÜK.1328

1.0 mm  90° SEA – 17.5 cm
Düz Şaft/Straight Shaft
ÜK.1329

0.6 mm  90° SEA – 17.5 cm
Düz Şaft/Straight Shaft
ÜK.1330

0.5 mm  90° HOUSE-TYPE – 16.5 cm
Düz Şaft/Straight Shaft
ÜK.1331

0.6 mm  RONIS – 15 cm
Düz Şaft/Straight Shaft
ÜK.1332

0.3 mm  90° HOUSE-TYPE – 16.5 cm
Düz Şaft/Straight Shaft
ÜK.1333

0.7 mm  RONIS – 15 cm
Düz Şaft/Straight Shaft
ÜK.1334

0.6 mm  SCHEER – 16 cm
Düz Şaft/Straight Shaft
ÜK.1335

0.8 mm  SCHEER – 16 cm
Düz Şaft/Straight Shaft
ÜK.1336

0.8 mm  SCHEER – 16 cm
Düz Şaft/Straight Shaft
ÜK.1337

0.9 mm  SCHEER – 16 cm
Düz Şaft/Straight Shaft
ÜK.1338

 16 cm
Düz Şaft/Straight Shaft
ÜK.1339

0.4 mm  90° PLESTER – 16 cm
Düz Şaft/Straight Shaft
ÜK.1340

 90° PLESTER – 16 cm
Düz Şaft/Straight Shaft
ÜK.1341

 45° PLESTER – 16 cm
Düz Şaft/Straight Shaft
ÜK.1342



1.7 mm  1.9 mm HOUGH – 16.5 cm
Bayonet Şaft/Bayonet Shaft
ÜK.1343

1.6 mm  MCGEE – 16 cm
1.5 mm  Bayonet Şaft/Bayonet Shaft
ÜK.1344



1.0 mm

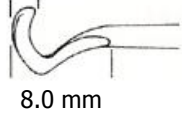

 SHEA – 16.5 cm
 Düz Şaft/Straight Shaft
 Sağ/Right **ÜK.1345**
 Sol/Left **ÜK.1346**

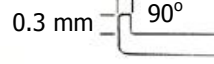
0.2 mm

 HOUSE – 16.5 cm
 Düz Şaft/Straight Shaft
ÜK.1347

 16 cm
 Düz Şaft/Straight Shaft
 Sağ/Right **ÜK.1348**
 Sol/Left **ÜK.1349**

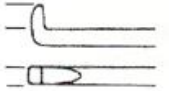

0.6 mm

 HOUGH – 15 cm
 10° Şaft/Shaft
ÜK.1350

0.4 mm

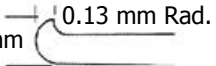

0.15 mm

 LIPPY – 17 cm
 20° Şaft/Shaft
 Öne Doğru/Forward **ÜK.1351**
 Geriye Doru/Backward **ÜK.1352**

0.3 mm

0.15 mm

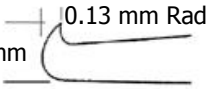
 LIPPY – 17 cm
 20° Şaft/Shaft
 Öne Doğru/Forward **ÜK.1353**
 Geriye Doru/Backward **ÜK.1354**

0.5 mm

0.4 mm

 SCHUKNECHT – 15.5 cm
 20° Şaft/Shaft
 Yukarı Doğru/Up Ward **ÜK.1355**
 Aşağı Doğru/Down Ward **ÜK.1356**

0.7 mm

 SCHUKNECHT – 15.5 cm
 20° Şaft/Shaft
 Yukarı Doğru/Up Ward **ÜK.1357**
 Aşağı Doğru/Down Ward **ÜK.1358**

1.0 mm

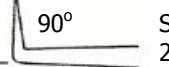
 SCHUKNECHT – 15.5 cm
 20° Şaft/Shaft
ÜK.1359

0.5 mm

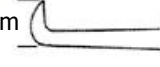
 MCGEE – 15.5 cm
 20° Şaft/Shaft
 Geriye Doğru/Backward **ÜK.1360**
 Öne Doğru/Forward **ÜK.1361**

0.75 mm

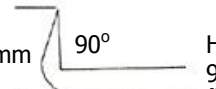
 HOUSE-TYPE – 16.5 cm
 90° Şaft/Shaft
ÜK.1362

0.25 mm

 HOUSE-TYPE – 16.5 cm
 30° Şaft/Shaft
ÜK.1363



0.5 mm 5.0 mm
FARRIOR – 15 cm
30° Şaft/Shaft
ÜK.1364

0.6 mm 5.0 mm
FARRIOR – 15 cm
30° Şaft/Shaft
ÜK.1365



2.0mm 4 mm Rad.
HOUGH – 15 cm
Düz Şaft/Straight Shaft
Sağ/Right ÜK.1366
0.7 mm Sol/Left ÜK.1367

1.6mm 1.2 mm Rad.
HOUGH – 15 cm
Düz Şaft/Straight Shaft
Sağ/Right ÜK.1368
1.0mm Sol/Left ÜK.1369



1.0 mm
SCHEER – 16 cm
Düz Şaft/Straight Shaft
ÜK.1370



1.6 mm 5.0 mm
ANTOLI-CANDELA – 16.5 cm
Düz Şaft/Straight Shaft
ÜK.1371

2.4 mm 2.4 mm
ANTOLI-CANDELA – 16.5 cm
Düz Şaft/Straight Shaft
ÜK.1372

2.7 mm 10°
ANTOLI-CANDELA – 16.5 cm
Düz Şaft/Straight Shaft
ÜK.1373
2.0 mm

0.7 mm 1.0 mm
AUSTIN – 16.5 cm
Düz Şaft/Straight Shaft
ÜK.1374
0.25 mm

1.0 mm 4.0 mm
AUSTIN – 16.5 cm
Düz Şaft/Straight Shaft
ÜK.1375

20° 2.2 mm
AUSTIN – 16.5 cm
Düz Şaft/Straight Shaft
ÜK.1376
0.6 mm

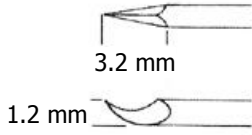

AUSTIN – 16.5 cm
Düz Şaft/Straight Shaft
ÜK.1377



GOLDMAN – 15 cm
Düz Şaft/Straight Shaft
ÜK.1378

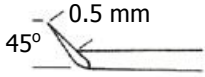

RONIS – 15 cm
Düz Şaft/Straight Shaft
ÜK.1379

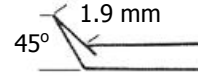

SCHEER – 16 cm
Düz Şaft/Straight Shaft
ÜK.1380

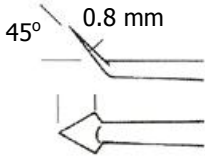

JORDAN – 17.5 cm
Düz Şaft/Straight Shaft
ÜK.1381

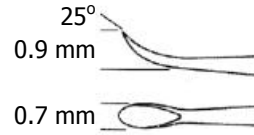

GUILFORD – 14 cm
Düz Şaft/Straight Shaft
ÜK.1382

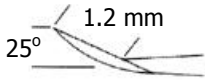

GUILFORD – 14 cm
Düz Şaft/Straight Shaft
ÜK.1383

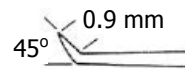

HARRISON – 15.5 cm
Düz Şaft/Straight Shaft
ÜK.1384



HARRISON – 15.5 cm
Düz Şaft/Straight Shaft
ÜK.1385

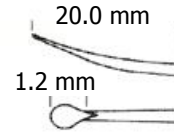

GUILFORD – 14 cm
Düz Şaft/Straight Shaft
ÜK.1386

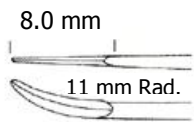

HOUSE-TYPE – 16.5 cm
Düz Şaft/Straight Shaft
ÜK.1387

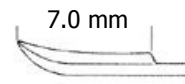

GUILFORD – 14 cm
Düz Şaft/Straight Shaft
ÜK.1388

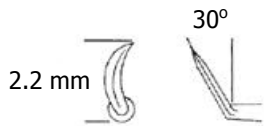

GUILFORD – 14 cm
Düz Şaft/Straight Shaft
ÜK.1389

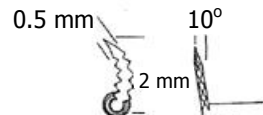

GUILFORD – 14 cm
Düz Şaft/Straight Shaft
10° Sağ/Right **ÜK.1390**
10° Sol/Left **ÜK.1391**

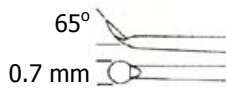

HOUSE-TYPE – 16 cm
Düz Şaft/Straight Shaft
ÜK.1392

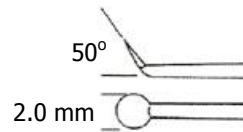

JORDAN – 17.5 cm
Düz Şaft/Straight Shaft
ÜK.1393

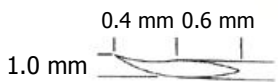

HOUGH – 15 cm
Düz Şaft/Straight Shaft
ÜK.1394

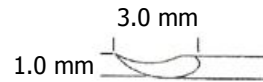

TABB – 17 cm
Düz Şaft/Straight Shaft
ÜK.1395



HOUGH – 15 cm
Düz Şaft/Straight Shaft
ÜK.1396



HOUSE-TYPE – 16.5 cm
Düz Şaft/Straight Shaft
ÜK.1397



RONIS – 15 cm
Düz Şaft/Straight Shaft
ÜK.1398



SHEA – 17.5 cm
Düz Şaft/Straight Shaft
ÜK.1399



SCHEER – 15 cm
Düz Şaft/Straight Shaft
ÜK.1400



GUILFORD – 14 cm
Düz Şaft/Straight Shaft
ÜK.1401

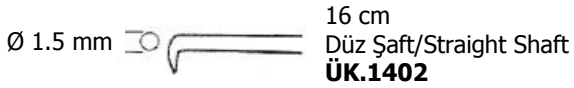

16 cm
Düz Şaft/Straight Shaft
ÜK.1402



16 cm
Düz Şaft/Straight Shaft
ÜK.1403



16 cm
Düz Şaft/Straight Shaft
ÜK.1404



16 cm
Düz Şaft/Straight Shaft
ÜK.1405



16 cm
Düz Şaft/Straight Shaft
ÜK.1406



PLESTER – 16 cm
Düz Şaft/Straight Shaft
ÜK.1407



16 cm
Düz Şaft/Straight Shaft
ÜK.1408



16 cm
Düz Şaft/Straight Shaft
ÜK.1409



16 cm
Düz Şaft/Straight Shaft
ÜK.1410



17 cm
Düz Şaft/Straight Shaft
ÜK.1411

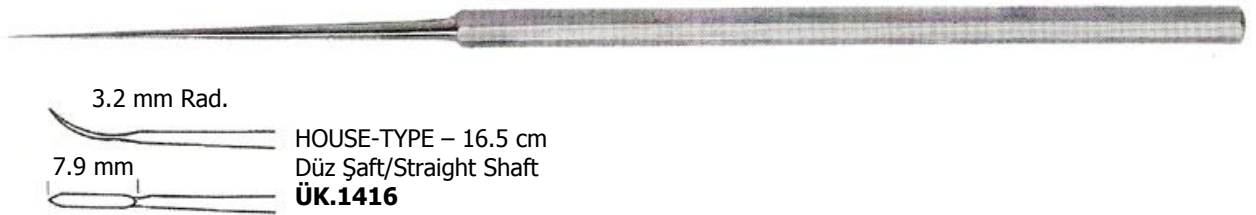
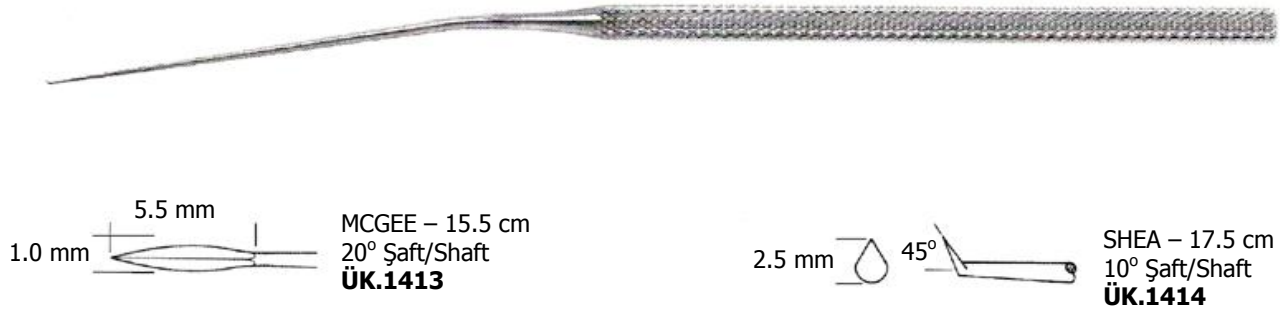



4.0 mm HOUSE-TYPE – 16.5 cm
Düz Şaft/Straight Shaft
ÜK.1421



5.0 mm HOUSE-TYPE – 16.5 cm
Düz Şaft/Straight Shaft
ÜK.1422



4.5 mm HOUSE-TYPE – 16.5 cm
Düz Şaft/Straight Shaft
ÜK.1423



4.5 mm RICHARDS – 17.5 cm
4.0 mm Düz Şaft/Straight Shaft
3.5 mm **ÜK.1424**



4.5 mm AUSTIN – 17 cm
4.0 mm Düz Şaft/Straight Shaft
3.5 mm **ÜK.1425**
0.6 mm

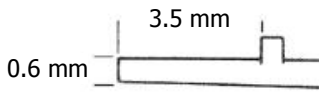

4.5 mm RONIS – 15 cm
4.0 mm Düz Şaft/Straight Shaft
3.5 mm **ÜK.1426**

3.5 mm SCHUKNECHT – 15.5 cm
20° Şaft/Shaft
ÜK.1427
0.6 mm

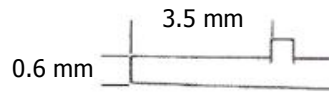

3.5 mm SCHUKNECHT – 15.5 cm
20° Şaft/Shaft
ÜK.1428
0.6 mm



9.5 mm RONIS – 15 cm
Düz Şaft/Straight Shaft
ÜK.1429



9.5 mm LARKIN – 17 cm
Düz Şaft/Straight Shaft
ÜK.1430

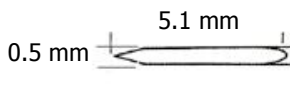

5.1 mm BUCKINGHAM – 15 cm
Düz Şaft/Straight Shaft
ÜK.1431
0.5 mm













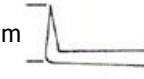

5.1 mm BUCKINGHAM – 15 cm
Düz Şaft/Straight Shaft
ÜK.1432
1.0 mm

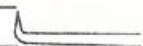

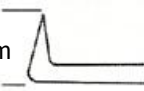
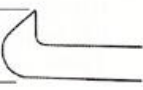
5.1 mm BUCKINGHAM – 15 cm
Düz Şaft/Straight Shaft
ÜK.1433
1.1 mm

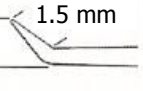
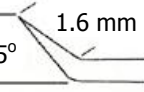
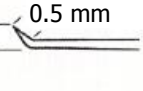
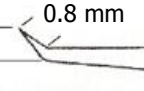
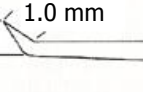
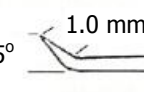
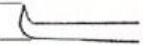

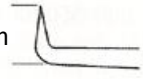
1.0 mm JORDAN – 17 cm
3.0 mm Bayonet Şaft/ Bayonet Shaft
0.8 mm **ÜK.1434**

1.5 mm		ANTOLI-CANDELA – 16.5 cm Düz Şaft/Straight Shaft ÜK.1435	3.0 mm		AUSTIN – 16.5 cm Düz Şaft/Straight Shaft ÜK.1436
0.3 mm		AUSTIN – 16.5 cm Düz Şaft/Straight Shaft ÜK.1437	1.1 mm		AUSTIN – 16.5 cm Düz Şaft/Straight Shaft ÜK.1438
0.7 mm		AUSTIN – 16.5 cm Düz Şaft/Straight Shaft ÜK.1439	1.4 mm		RONIS – 15 cm Düz Şaft/Straight Shaft ÜK.1440
0.8 mm		RONIS – 15 cm Düz Şaft/Straight Shaft ÜK.1441	1.0 mm		SCHEER – 16 cm Düz Şaft/Straight Shaft ÜK.1442
2.0 mm		GUILFORD – 14 cm Düz Şaft/Straight Shaft ÜK.1443	1.3 mm		SHEA – 17.5 cm Düz Şaft/Straight Shaft ÜK.1444
1.0 mm		SCHEER – 16 cm Düz Şaft/Straight Shaft ÜK.1445	45° 1.0 mm		GUILFORD – 14 cm Düz Şaft/Straight Shaft ÜK.1446
45° 1.5 mm		ANTOLI-CANDELA – 16.5 cm Düz Şaft/Straight Shaft ÜK.1447	45° 1.6 mm		GUILFORD – 14 cm Düz Şaft/Straight Shaft ÜK.1448
45° 0.5 mm		RONIS – 15 cm Düz Şaft/Straight Shaft ÜK.1449	45° 0.8 mm		ANTOLI-CANDELA – 16.5 cm Düz Şaft/Straight Shaft ÜK.1450
45° 1.0 mm		ANTOLI-CANDELA – 16.5 cm Düz Şaft/Straight Shaft ÜK.1451	45° 1.0 mm		RONIS – 15 cm Düz Şaft/Straight Shaft ÜK.1452
0.6 mm		SCHEER – 16 cm Düz Şaft/Straight Shaft ÜK.1453	0.3 mm		GOLDMAN – 15 cm Düz Şaft/Straight Shaft ÜK.1454
0.6 mm		GOLDMAN – 15 cm Düz Şaft/Straight Shaft ÜK.1455	1.1 mm		SCHEER – 16 cm Düz Şaft/Straight Shaft ÜK.1456

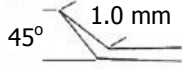

AUSTIN – 16.5 cm
Düz Şaft/Straight Shaft
ÜK.1457

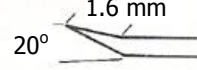

SCHEER – 16 cm
Düz Şaft/Straight Shaft
ÜK.1458



AUSTIN – 16.5 cm
Düz Şaft/Straight Shaft
ÜK.1459



GUILFORD – 14 cm
Düz Şaft/Straight Shaft
ÜK.1460



GUILFORD – 14 cm
Düz Şaft/Straight Shaft
ÜK.1461



SCHEER – 16 cm
Düz Şaft/Straight Shaft
ÜK.1462

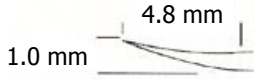

ANTOLI-CANDELA – 16.5 cm
Düz Şaft/Straight Shaft
ÜK.1463



HOUGH – 15 cm
Düz Şaft/Straight Shaft
ÜK.1464



HOUSE-TYPE – 16.5 cm
Düz Şaft/Straight Shaft
ÜK.1465

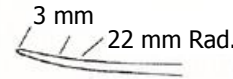

GOLDMAN – 15 cm
Düz Şaft/Straight Shaft
Künt/Blunt **ÜK.1466**
Sivri/Sharp **ÜK.1467**

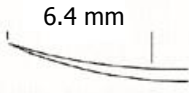

SCHEER – 16 cm
Düz Şaft/Straight Shaft
ÜK.1468

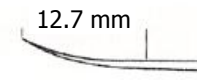

HOUGH – 15 cm
Düz Şaft/Straight Shaft
ÜK.1469

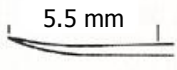

SHEA – 16 cm
Düz Şaft/Straight Shaft
ÜK.1470

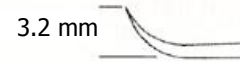

HOUSE-TYPE – 16.5 cm
Düz Şaft/Straight Shaft
ÜK.1471

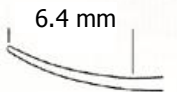

HOUSE-TYPE – 16.5 cm
Düz Şaft/Straight Shaft
ÜK.1472



AUSTIN – 16.5 cm
Düz Şaft/Straight Shaft
ÜK.1473

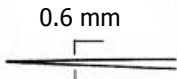

RONIS – 15 cm
Düz Şaft/Straight Shaft
ÜK.1474

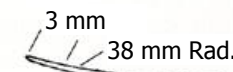

GOLDMAN – 15 cm
Düz Şaft/Straight Shaft
Künt/Blunt **ÜK.1475**
Sivri/Sharp **ÜK.1476**

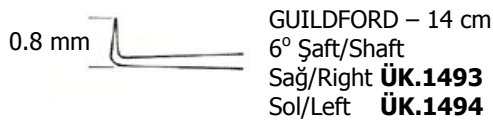
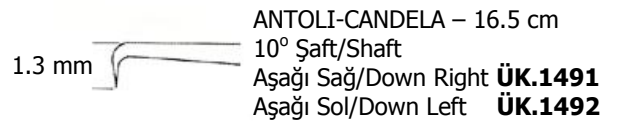
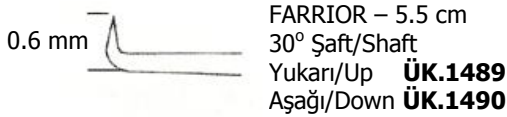
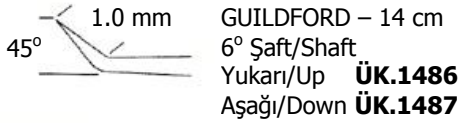
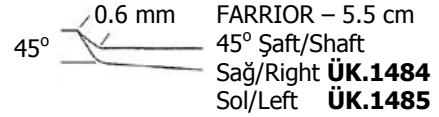
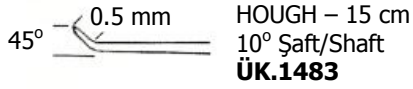
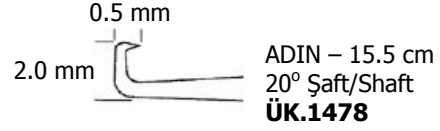
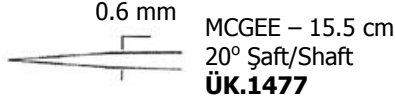



4.8 mm
JORDAN – 16.5 cm
Bayonet Şaft/Bayonet Shaft
Yukarı Doğru/Up Ward **ÜK.1497**
Aşağı Doğru/Down Ward **ÜK.1498**

0.7 mm
JORDAN – 16.5 cm
Bayonet Şaft/Bayonet Shaft
ÜK.1499

0.7 mm
JORDAN – 16.5 cm
Bayonet Şaft/Bayonet Shaft
Yukarı/Up **ÜK.1500**
Aşağı/Down **ÜK.1501**
Sol/Left **ÜK.1502**

0.6 mm
JORDAN – 16.5 cm
Bayonet Şaft/Bayonet Shaft
ÜK.1503

0.9 mm
JORDAN – 16.5 cm
Bayonet Şaft/Bayonet Shaft
ÜK.1504



1.4 mm
15°
RONIS – 15 cm
Düz Şaft/Straight Shaft
ÜK.1505

0.8 mm
10°
1.5 mm
MCGEE – 15 cm
Düz Şaft/Straight Shaft
ÜK.1506

1.4 mm
16 cm
Düz Şaft/Straight Shaft
ÜK.1507

14.2 mm
3.0 mm
GOLDMAN – 15 cm
Düz Şaft/Straight Shaft
ÜK.1508



0.4 mm
HOUSE-TYPE – 16.5 cm
Düz Şaft/Straight Shaft
ÜK.1509

1.8 mm
HOUSE-TYPE – 16.5 cm
Düz Şaft/Straight Shaft
ÜK.1510

2.3 mm
HOUSE-TYPE – 16 cm
Düz Şaft/Straight Shaft
ÜK.1511



3.4 mm 19 mm Rad.
HOUSE-TYPE – 16 cm
Bayonet Şaft/Bayonet Shaft
ÜK.1512

0.4 mm 2.4 mm
1.9 mm
HOUSE-TYPE – 16 cm
Bayonet Şaft/Bayonet Shaft
ÜK.1513



0.4 mm
1.3 mm
1.5 mm
HOUGH – 15 cm
Düz Şaft/Straight Shaft
ÜK.1514



0.9 mm 0.5 mm
SCHUKNECHT – 15.5 cm
20° Şaft/Shaft
ÜK.1515



0.5 mm
20°
GOLDMAN – 15 cm
Düz Şaft/Straight Shaft
ÜK.1516

0.8 mm
3.2 mm
GOLDMAN – 15 cm
Düz Şaft/Straight Shaft
ÜK.1517

0.6 mm 2.0 mm
30°
ANTOLI-CANDELA – 16.5 cm
Düz Şaft/Straight Shaft
ÜK.1518

1.3 mm
45°
AUSTIN – 17 cm
Düz Şaft/Straight Shaft
ÜK.1519

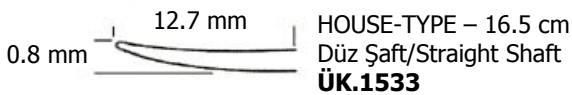
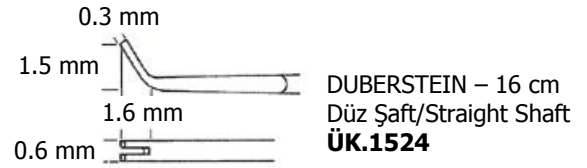
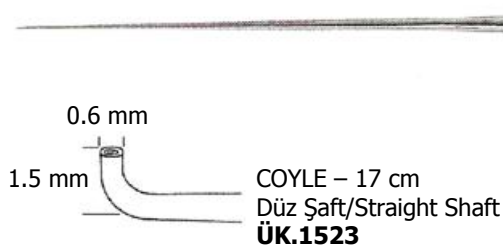
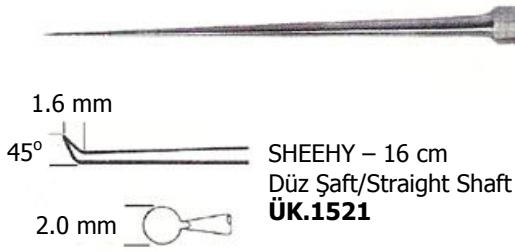

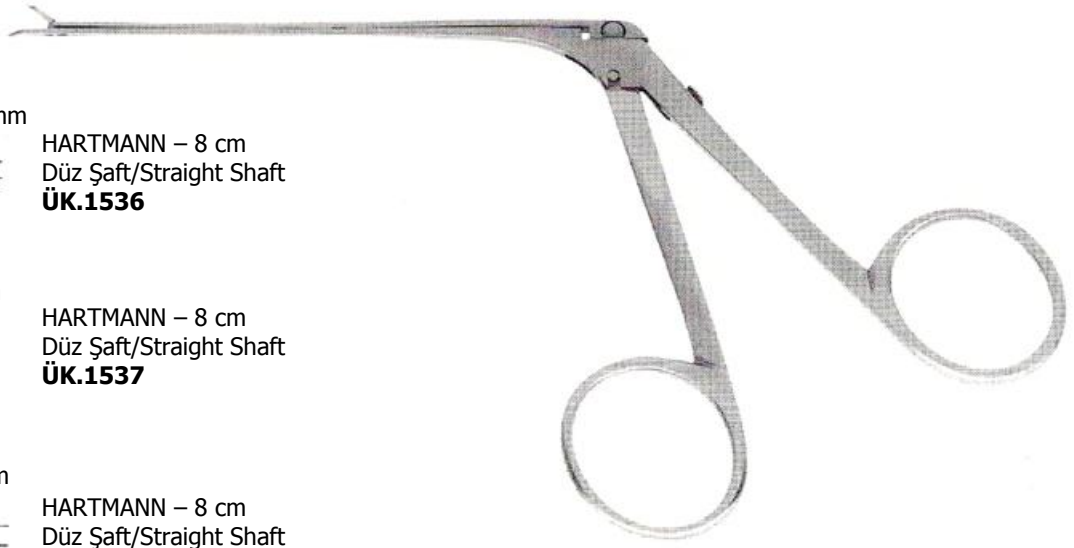

3.0 mm
HARTMANN – 8 cm
Düz Şaft/Straight Shaft
ÜK.1536

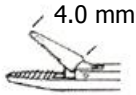

4.0 mm
HARTMANN – 8 cm
Düz Şaft/Straight Shaft
ÜK.1537



7.0 mm
HARTMANN – 8 cm
Düz Şaft/Straight Shaft
ÜK.1538

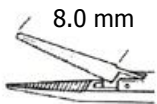

8.0 mm
HARTMANN – 8 cm
Düz Şaft/Straight Shaft
ÜK.1539

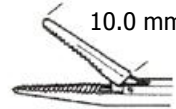

10.0 mm
HARTMANN – 8 cm
Düz Şaft/Straight Shaft
ÜK.1540

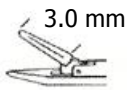

3.0 mm
RICHARDS – 8 cm
Düz Şaft/Straight Shaft
ÜK.1541

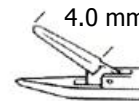

4.0 mm
RICHARDS – 8 cm
Düz Şaft/Straight Shaft
ÜK.1542



3.0 mm
HARTMANN – 8 cm
Düz Şaft/Straight Shaft
ÜK.1543

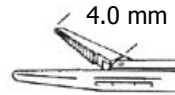

4.0 mm
HARTMANN – 8 cm
Düz Şaft/Straight Shaft
ÜK.1544

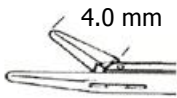

4.0 mm
RICHARDS – 8 cm
Düz Şaft/Straight Shaft
ÜK.1545

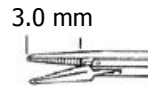

3.0 mm
HARTMANN – 8 cm
Düz Şaft/Straight Shaft
ÜK.1546

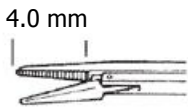

4.0 mm
HARTMANN – 8 cm
Düz Şaft/Straight Shaft
ÜK.1547

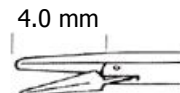

4.0 mm
RICHARDS – 8 cm
Düz Şaft/Straight Shaft
ÜK.1548

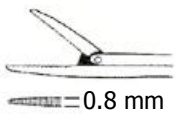

4.0 mm
RICHARDS – 8 cm
Düz Şaft/Straight Shaft
ÜK.1549

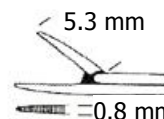

5.3 mm
RICHARDS – 8 cm
Düz Şaft/Straight Shaft
ÜK.1550

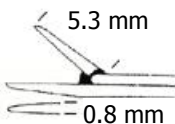

5.3 mm
RICHARDS – 8 cm
Düz Şaft/Straight Shaft
ÜK.1551

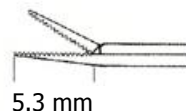

5.3 mm
RICHARDS – 8 cm
Düz Şaft/Straight Shaft
ÜK.1552

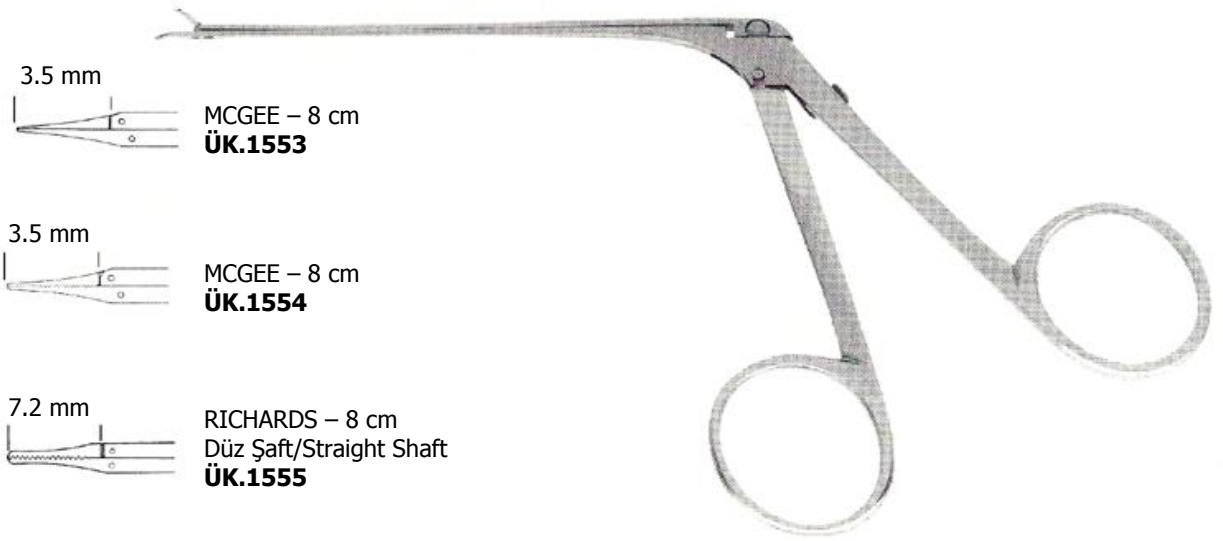

3.5 mm
MCGEE – 8 cm
ÜK.1553

3.5 mm
MCGEE – 8 cm
ÜK.1554

7.2 mm
RICHARDS – 8 cm
Düz Şaft/Straight Shaft
ÜK.1555

3.0 mm
HARTMANN – 8 cm
Düz Şaft/Straight Shaft
ÜK.1556

4.0 mm
HARTMANN – 8 cm
Düz Şaft/Straight Shaft
ÜK.1557

3.0 mm
HARTMANN – 8 cm
Düz Şaft/Straight Shaft
ÜK.1558

4.0 mm
HARTMANN – 8 cm
Düz Şaft/Straight Shaft
ÜK.1559

5.3 mm
RICHARDS – 8 cm
ÜK.1560

5.3 mm
RICHARDS – 8 cm
Düz Şaft/Straight Shaft
ÜK.1561

5.3 mm
RICHARDS – 8 cm
ÜK.1562

5.3 mm
RICHARDS – 8 cm
ÜK.1563

3.5 mm
RICHARDS – 8 cm
Yukarı Eğri/Curved Upwards
Düz Şaft/Straight Shaft
ÜK.1564

3.8 mm
RICHARDS – 8 cm
Aşağı Eğri/Curved Downwards
Düz Şaft/Straight Shaft
ÜK.1565

4.0 mm
RICHARDS – 8 cm
Sağa Eğri/Curved Right
Düz Şaft/Straight Shaft
ÜK.1566

4.0 mm
RICHARDS – 8 cm
Sola Eğri/Curved Left
Düz Şaft/Straight Shaft
ÜK.1567

3.6 mm
RICHARDS – 8 cm
Düz Şaft/Straight Shaft
0.8 mm
ÜK.1568

3.8 mm
RICHARDS – 8 cm
Düz Şaft/Straight Shaft
0.8 mm
ÜK.1569

4.0 mm
RICHARDS – 8 cm
Düz Şaft/Straight Shaft
Sol Uçlu/Left Tip
0.8 mm
ÜK.1570

4.0 mm
RICHARDS – 8 cm
Düz Şaft/Straight Shaft
Sağ Uçlu/Right Tip
0.8 mm
ÜK.1571



3.0 mm



SHEA – 8 cm
Düz Şaft/Straight Shaft
ÜK.1572

4.0 mm



SHEA – 8 cm
Düz Şaft/Straight Shaft
ÜK.1573

3.0 mm



SHEA – 8 cm
Düz Şaft/Straight Shaft
ÜK.1574

4.0 mm



SHEA – 8 cm
Düz Şaft/Straight Shaft
ÜK.1575

3.0 mm



SHEA – 8 cm
Düz Şaft/Straight Shaft
ÜK.1576

4.0 mm



SHEA – 8 cm
Düz Şaft/Straight Shaft
ÜK.1577

3.0 mm



SHEA – 8 cm
Düz Şaft/Straight Shaft
ÜK.1578

4.0 mm



SHEA – 8 cm
Düz Şaft/Straight Shaft
ÜK.1579

1.3 mm

0.8 mm



SHEA – 8 cm
Uzun Şaft/X Long Shaft
ÜK.1580

4.7 mm



SHEA – 8 cm
Düz Şaft/Straight Shaft
ÜK.1581

3.7 mm



SHEA – 8 cm
Yukarı Eğri/Curved Upwards
Düz Şaft/Straight Shaft
ÜK.1582

3.9 mm



SHEA – 8 cm
Aşağı Eğri/Curved Downwards
Düz Şaft/Straight Shaft
ÜK.1583

4.0 mm



SHEA – 8 cm
Sola Eğri/Curved Left
Düz Şaft/Straight Shaft
ÜK.1584



4.0 mm

SHEA – 8 cm
Sağa Eğri/Curved Right
Düz Şaft/Straight Shaft
ÜK.1585



MALLEUS – 8 cm
Düz Şaft/Straight Shaft
ÜK.1586



TABB – 8 cm
Düz Şaft/Straight Shaft
ÜK.1587

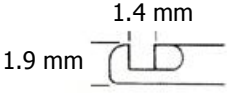

HOUSE-TYPE – 13 cm
Düz Şaft/Straight Shaft
ÜK.1588

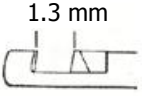

RICHARDS – 15 cm
Düz Şaft/Straight Shaft
ÜK.1589

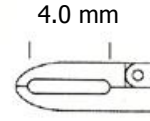

TABB – 8 cm
Düz Şaft/Straight Shaft
ÜK.1590



PISTON – 8 cm
Düz Şaft/Straight Shaft
ÜK.1591



MCGEE – 8 cm
Düz Şaft/Straight Shaft
ÜK.1592

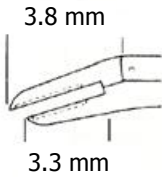

MCGEE – 8 cm
Düz Şaft/Straight Shaft
ÜK.1593

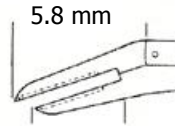

MCGEE – 8 cm
Düz Şaft/Straight Shaft
ÜK.1594

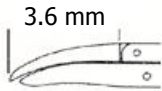

SCHUKNECHT – 8 cm
Düz Şaft/Straight Shaft
ÜK.1595

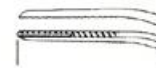

RONIS – 15 cm
Düz Şaft/Straight Shaft
ÜK.1596



FISCH – 8 cm
Düz Şaft/Straight Shaft
Sağ/Right **ÜK.1597**

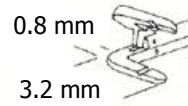

FISCH – 8 cm
Düz Şaft/Straight Shaft
Sol/Left **ÜK.1598**



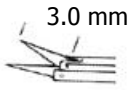
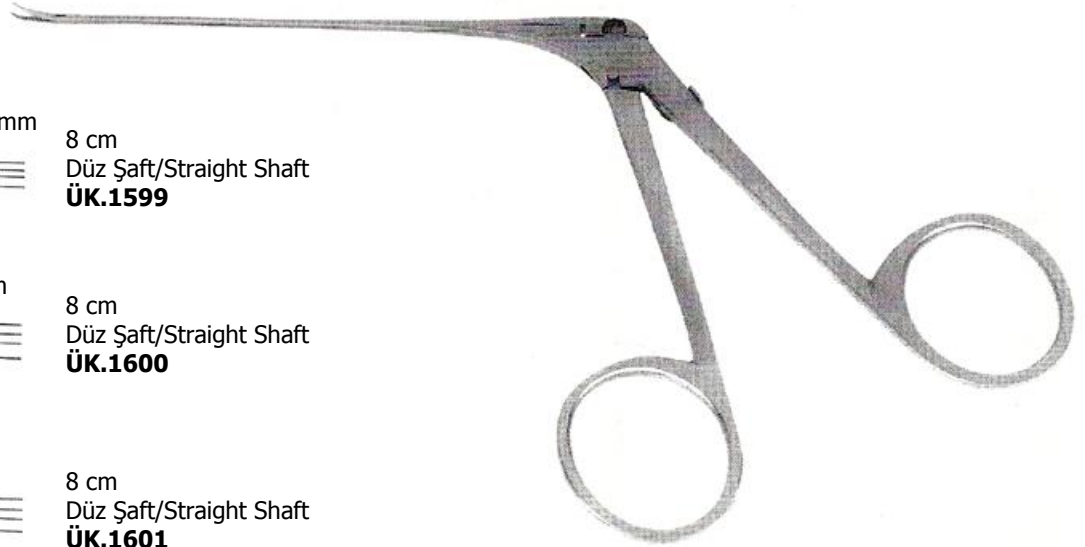

3.0 mm
8 cm
Düz Şaft/Straight Shaft
ÜK.1599

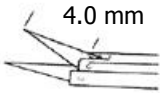

4.0 mm
8 cm
Düz Şaft/Straight Shaft
ÜK.1600

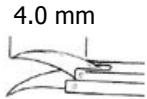

4.0 mm
8 cm
Düz Şaft/Straight Shaft
ÜK.1601

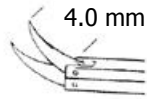

4.0 mm
8 cm
Düz Şaft/Straight Shaft
ÜK.1602

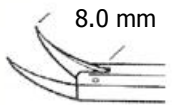

8.0 mm
SHEA – 8 cm
Düz Şaft/Straight Shaft
ÜK.1604

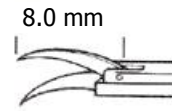

8.0 mm
SHEA – 8 cm
Düz Şaft/Straight Shaft
ÜK.1603

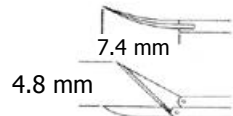

7.4 mm
4.8 mm
SHEA – 8 cm
Düz Şaft/Straight Shaft
Sağ/Right **ÜK.1605**
Sol/Left **ÜK.1606**

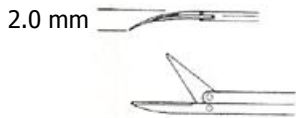

2.0 mm
RICHARDS – 8 cm
Düz Şaft/Straight Shaft
Sağ/Right **ÜK.1607**
Sol/Left **ÜK.1608**

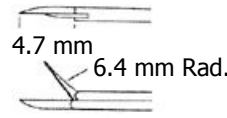

4.7 mm
6.4 mm Rad.
MCGEE – 8 cm
Düz Şaft/Straight Shaft
ÜK.1609

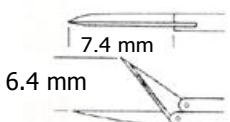

7.4 mm
6.4 mm
SHEA – 8 cm
ÜK.1610

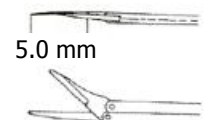

5.0 mm
RICHARDS – 8 cm
Düz Şaft/Straight Shaft
ÜK.1611



ÜK.1612
ÜK.1613 – ÜK.1617
Aletleri için Sap
Handle to hold instruments
ÜK.1613 – ÜK.1617

1/1



HEERMANN – 9 cm
ÜK.1613 – ÜK.1617

1/2



0.7 mm
ÜK.1613



0.7 mm
ÜK.1614



1.0 mm
ÜK.1615



1.5 mm
ÜK.1616



3.0 mm
ÜK.1617

1/1



HEERMANN – 19.5 cm
ÜK.1618

1/2



16.5 cm
ÜK.1619

1/2



16.5 cm
Damar Presi
Vein Press
ÜK.1620

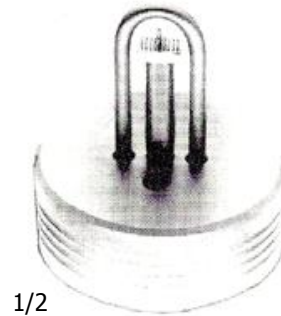

SCHUKNECHT
ÜK.1621

1/2



MANN
ÜK.1622

1/2

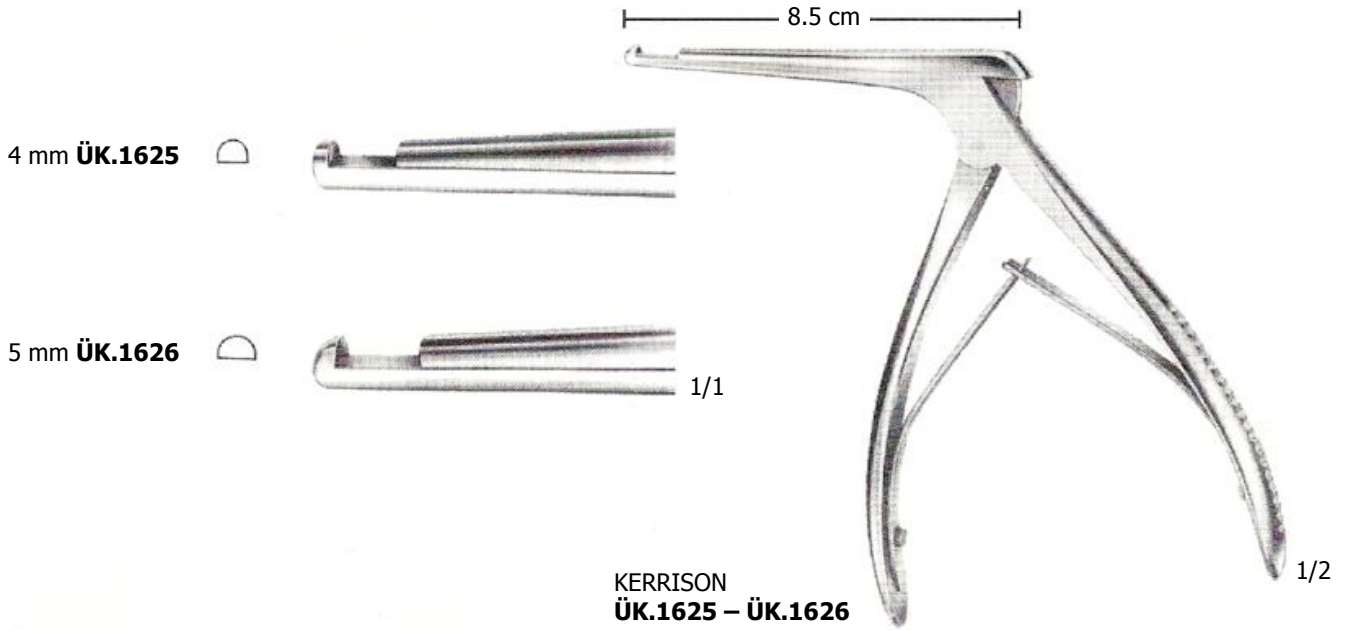
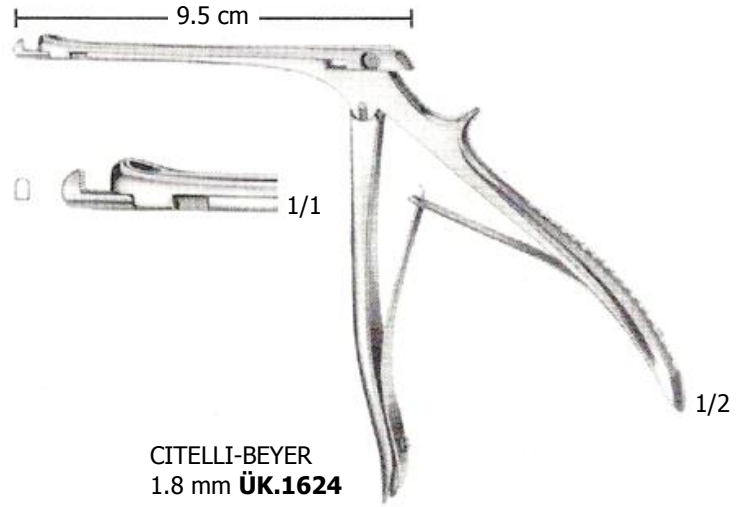
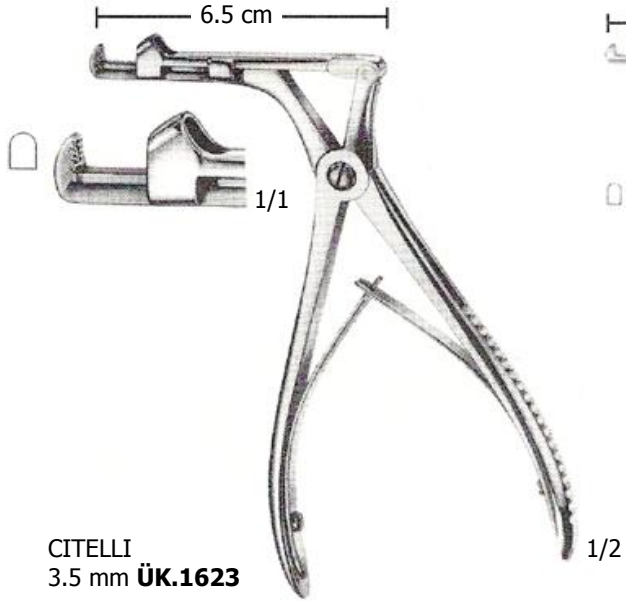

BECKMANN - 15 cm
Yana Doğru Eğri
Curved Sidewards
ÜK.1627



3. BÖLÜM

RİNOLOJİ, RİNOPLASTİ
Rhinology, Rhinoplasty

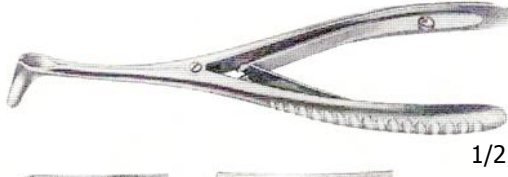

TIECK-HALLE – 13.5 cm
Çocuklar İçin/For Children
ÜK.1628 – ÜK.1629



ÜK.1628

ÜK.1629

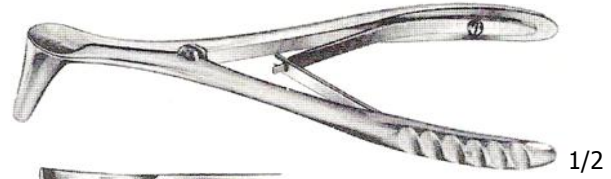

WIENER MODELL – 14 cm
ÜK.1630

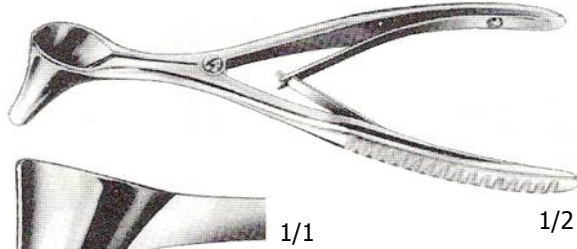

WIENER MODELL – 14 cm
ÜK.1631

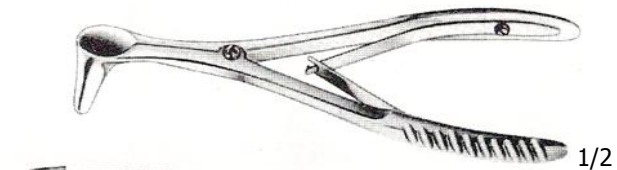
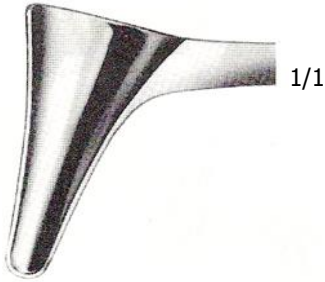

WIENER MODELL – 14 cm
ÜK.1632

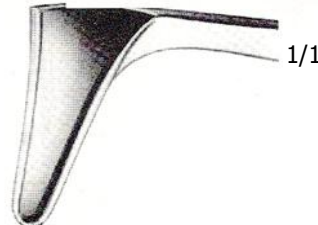

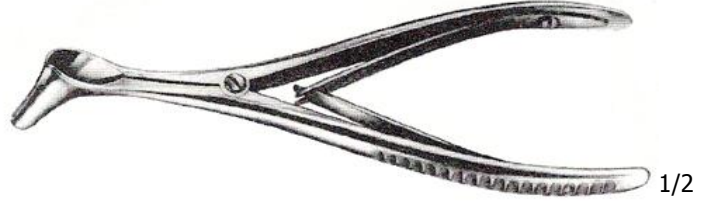

HARTMANN – 14 cm
ÜK.1633 – ÜK.1635

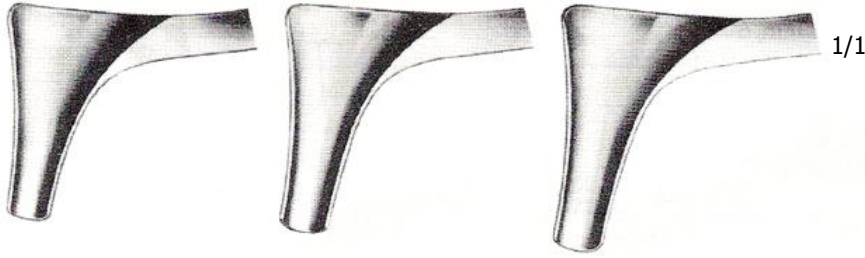

ÜK.1633

ÜK.1634

ÜK.1635

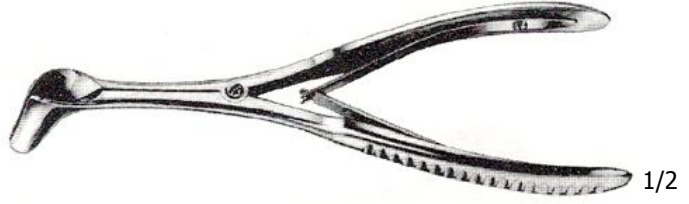

HARTMANN-HALLE – 15.5 cm
ÜK.1636 – ÜK.1638

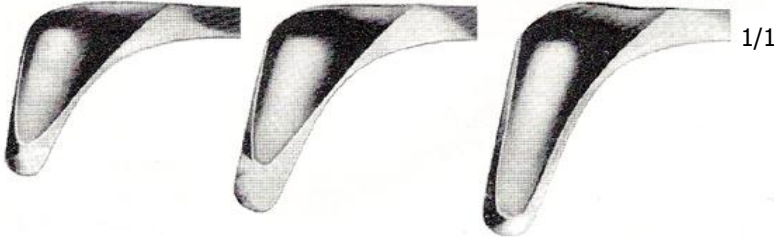

ÜK.1636

ÜK.1637

ÜK.1638

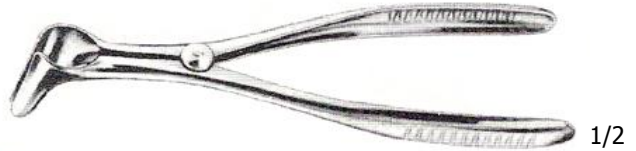

HARTMANN – 14.5 cm
ÜK.1639



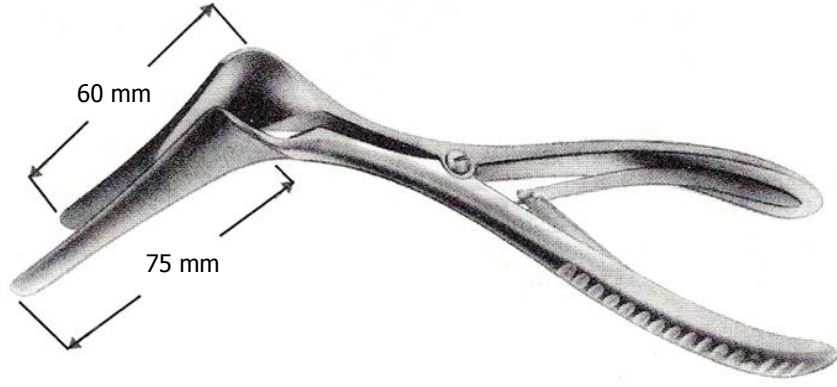

Kısa Sol Bleyd
Left Blade Shortened
ÜK.1640

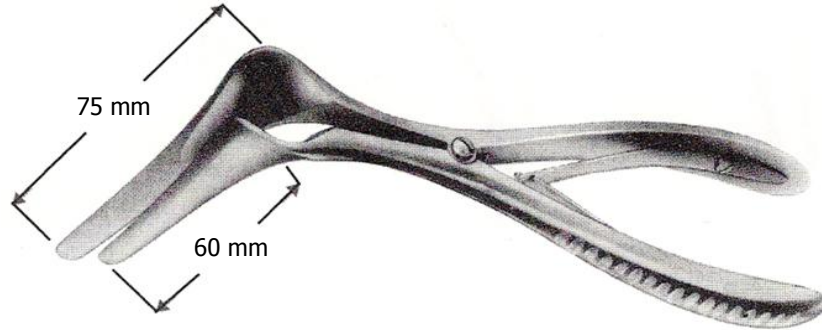

Kısa Sağ Bleyd
Right Blade Shortened
ÜK.1641



BECKMANN – 15 cm
Yana Doğru Eğri/Curved Sideways
ÜK.1642

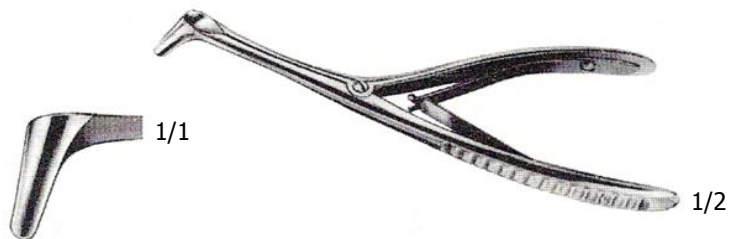

BECKMANN – 14 cm
Çocuklar İçin/For Children
Yana Doğru Eğri/Curved Sideways
ÜK.1643

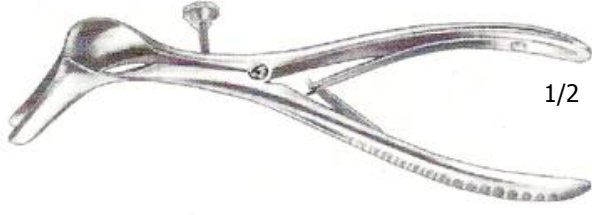

1/2

COTTLE – 13.5 cm
ÜK.1644 – ÜK.1647



35 x7 mm
ÜK.1644



55 x7 mm
ÜK.1645



76 x7 mm
ÜK.1646

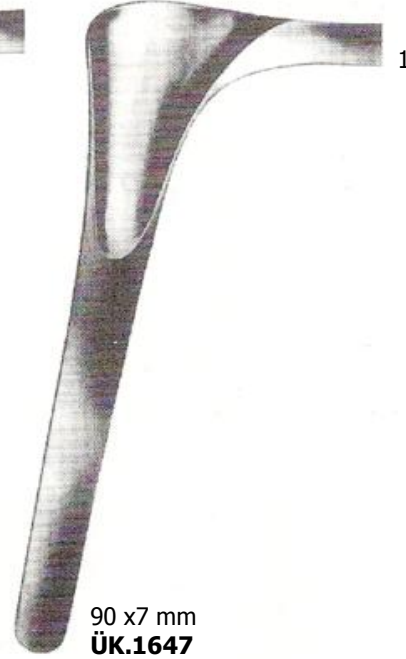

90 x7 mm
ÜK.1647

1/1

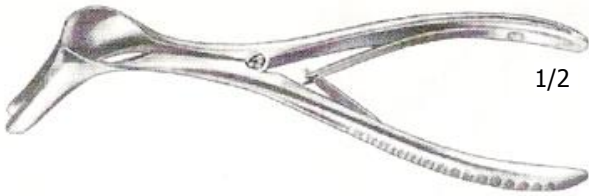

1/2

COTTLE – 13.5 cm
ÜK.1648 – ÜK.1651

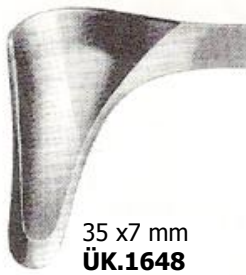

35 x7 mm
ÜK.1648

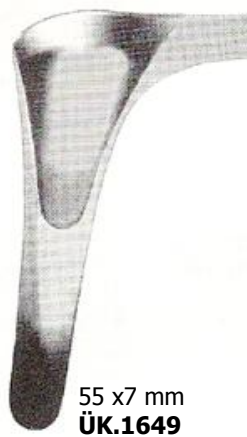

55 x7 mm
ÜK.1649

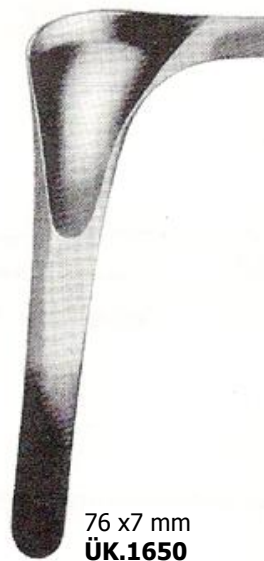

76 x7 mm
ÜK.1650

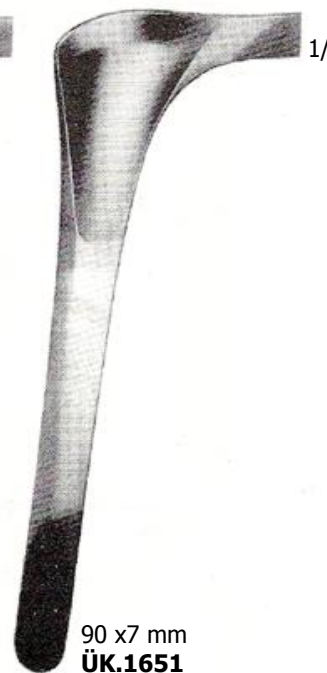

90 x7 mm
ÜK.1651

1/1

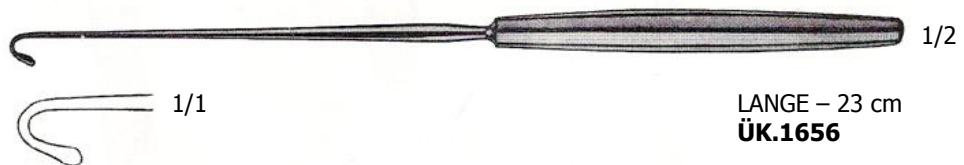



LUBET-BARBON – 20 cm
ÜK.1657

1/2

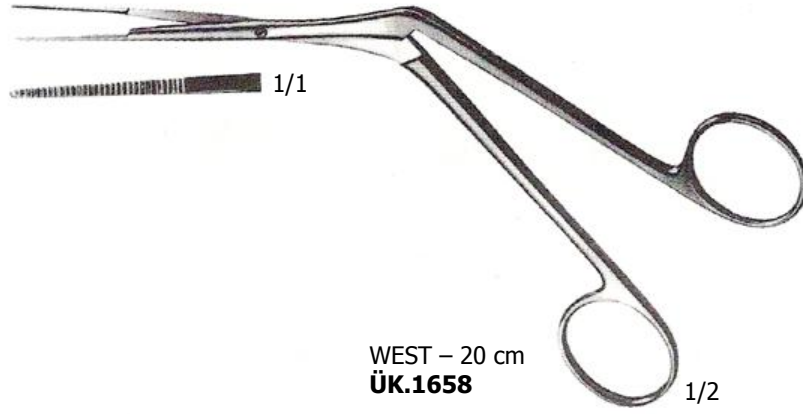

WEST – 20 cm
ÜK.1658

1/2

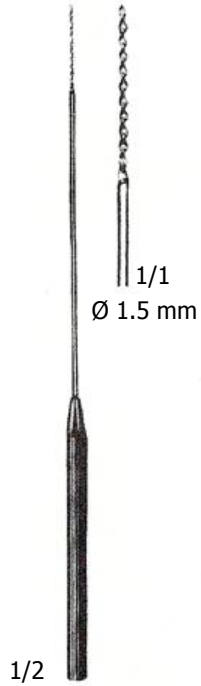

1/2
18 cm
Burmali/Spiral
ÜK.1659

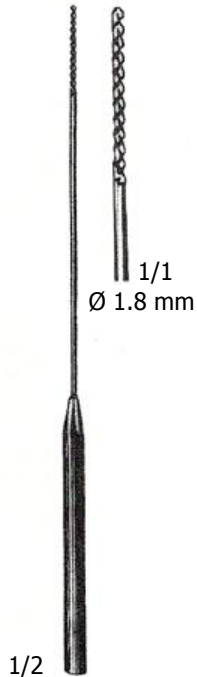

1/2
18 cm
Burmali/Spiral
ÜK.1660



1/2
18 cm
JOBSON-HORNE
ÜK.1661

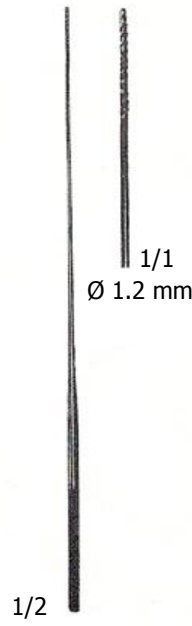

1/2
16 cm
FARREL
ÜK.1662

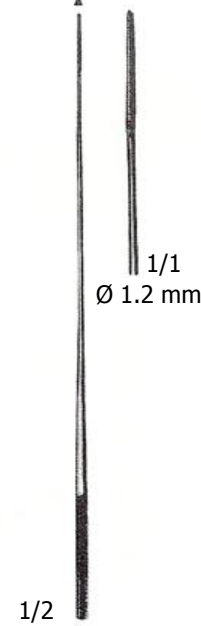

1/2
16 cm
LATHBURY-FARREL
Üçgen Tırtıl
Triangular Serrated
ÜK.1663

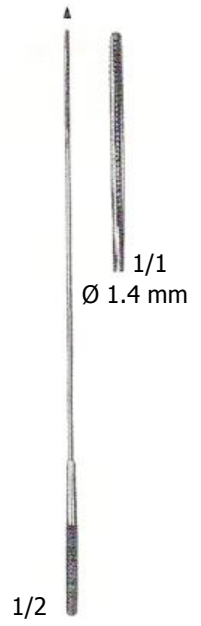

1/2
16 cm
Üçgen Tırtıl
Triangular Serrated
ÜK.1664

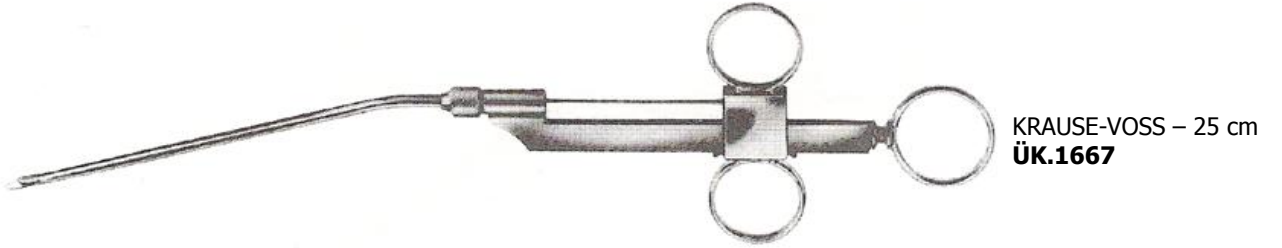
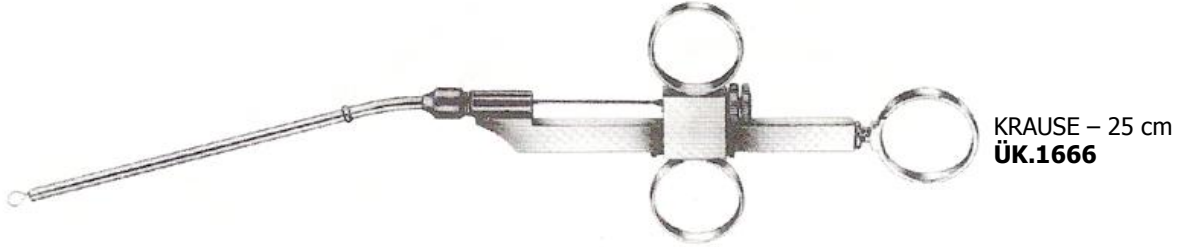
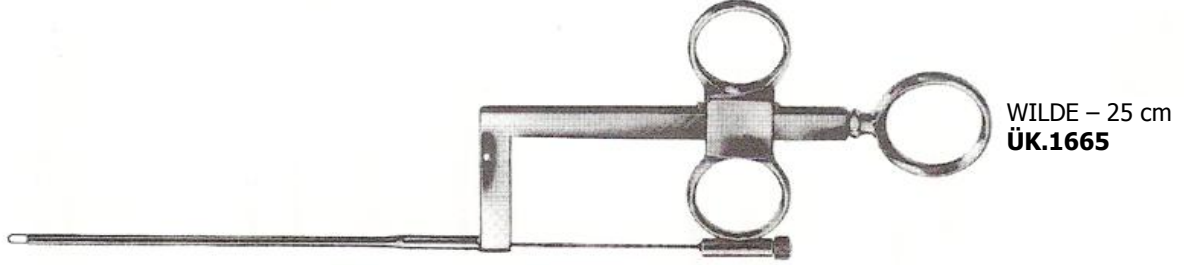

Yumuşak Tel/Wire Soft
10 m'lik tel bobini/Wire Coils Of 10 m
Ø 0.3 mm ÜK.1670

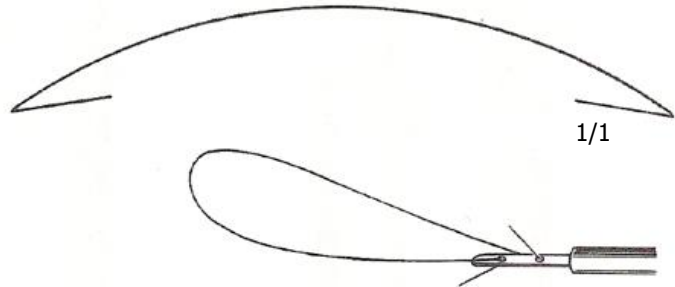

12'lik Paket/Package of 12 pcs
Ø 0.3 mm ÜK.1669

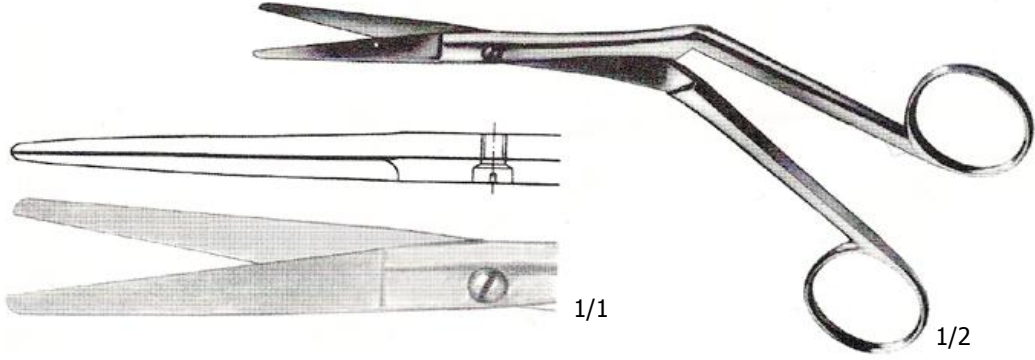

KIRSTEIN – 19 cm
ÜK.1671

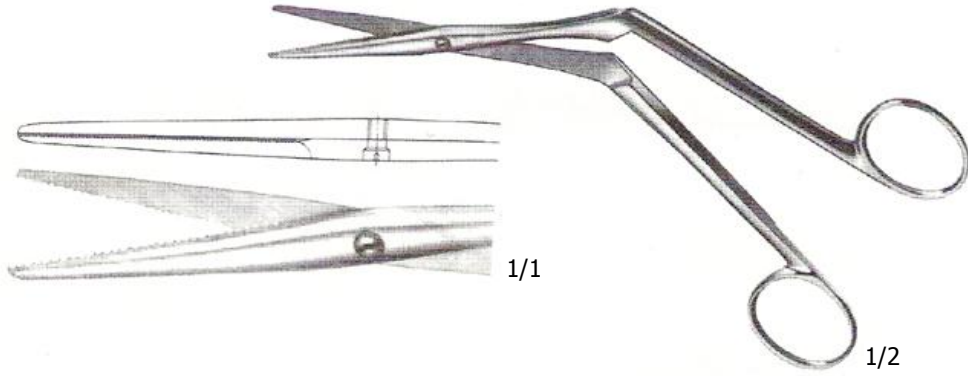

KIRSTEIN – 17.5 cm
Çift Ağız Tırtıllı/Both Jaws Serrated
ÜK.1672

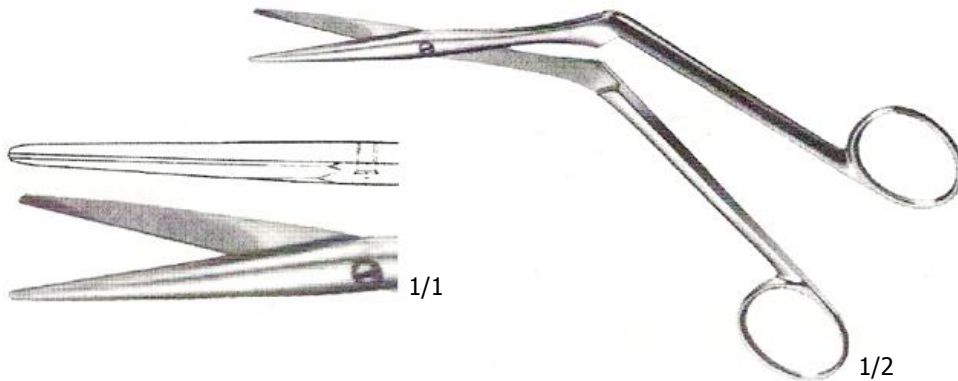

HEYMANN-KNIGHT – 17.5 cm
ÜK.1673

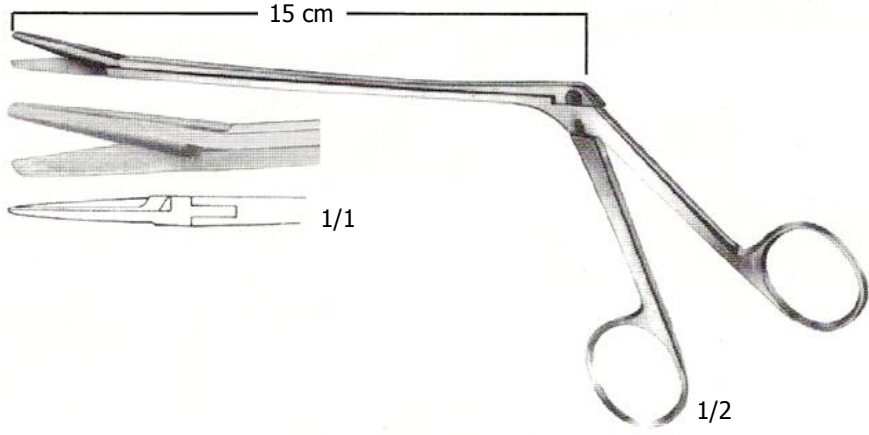

OLIVECRONA – 22.5 cm
ÜK.1674

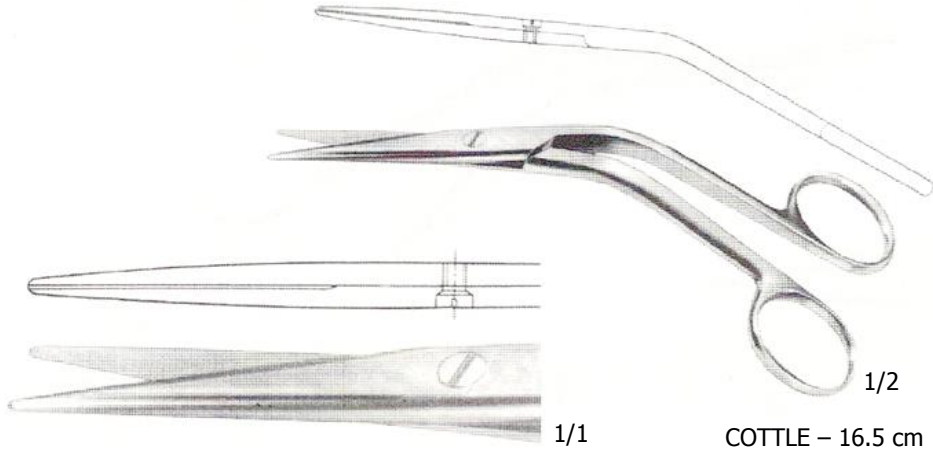

COTTLE – 16.5 cm
Künt/Blunt
ÜK.1675

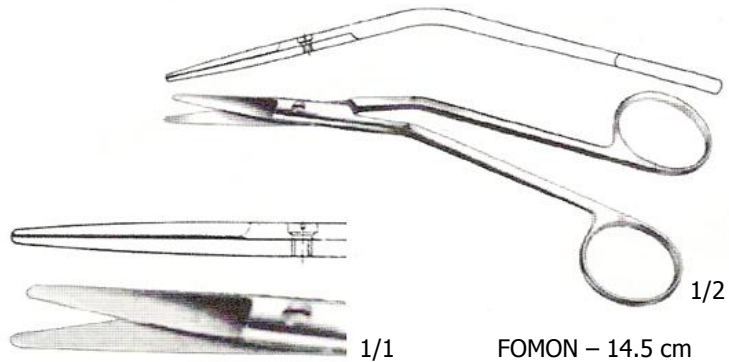

FOMON – 14.5 cm
Künt/Blunt
Çift Ağız Tırtıllı/Both Jaws Serrated
ÜK.1676

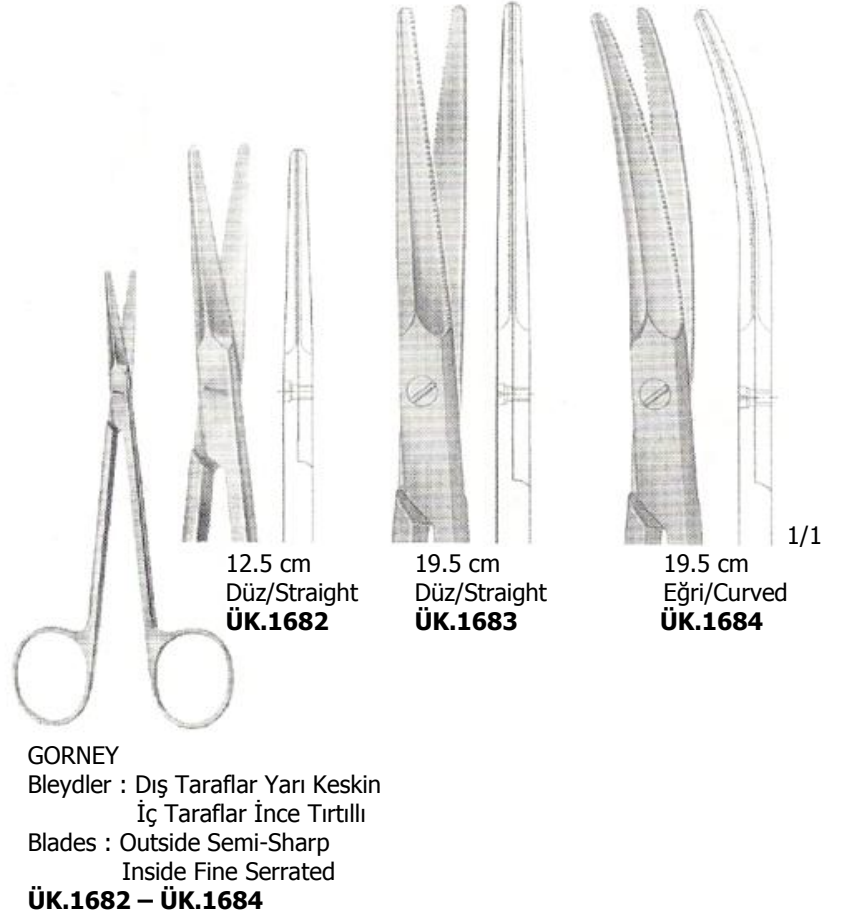
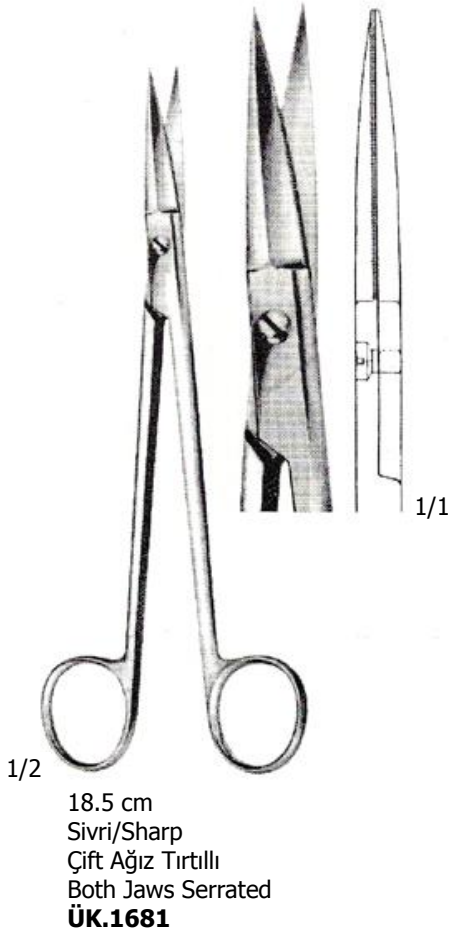
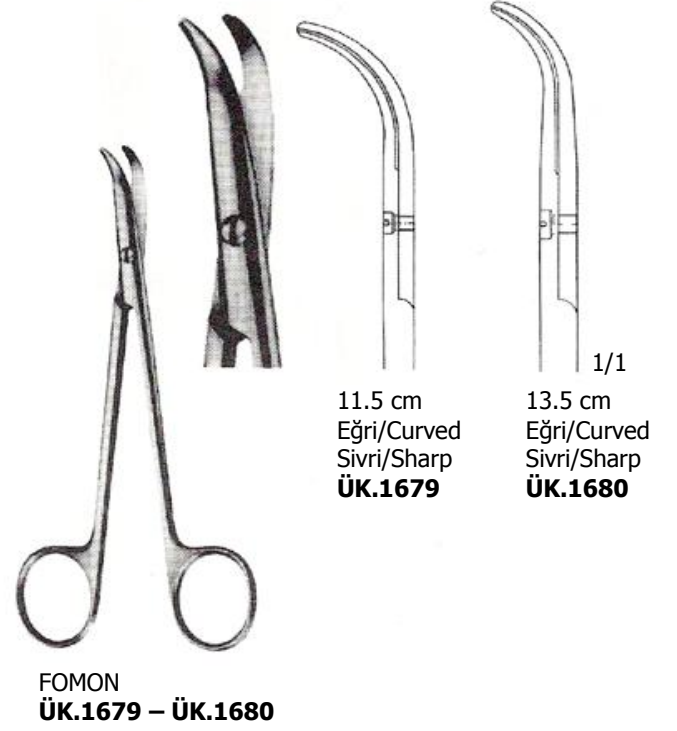
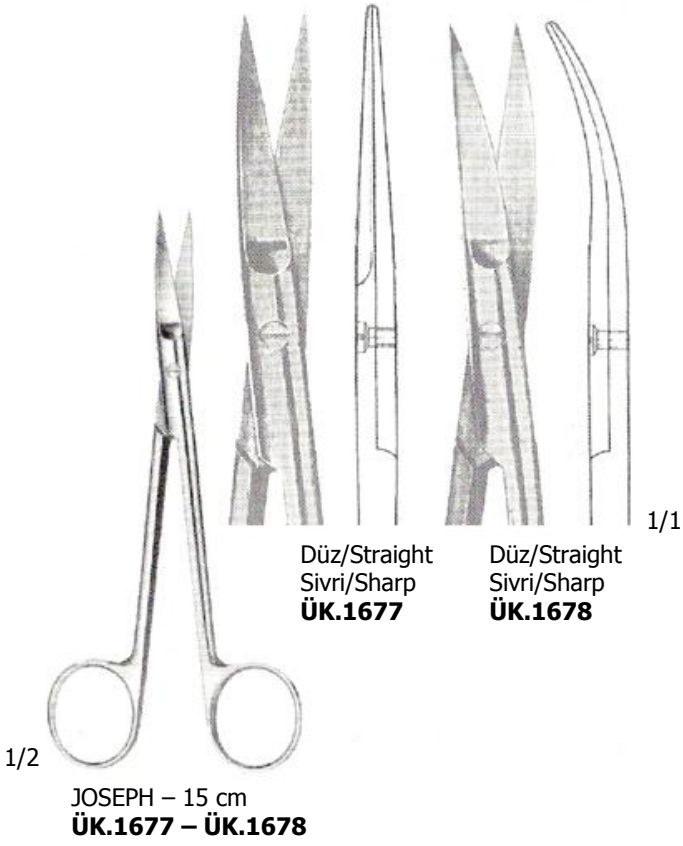



1/2

BRÜNING'S – 16 cm
ÜK.1685



1/2

FREER – 15.5 cm
ÜK.1686



1/2

JOSEPH – 14.5 cm
ÜK.1687 – ÜK.1688



Düz/Straight
ÜK.1687



Eğri/Curved
ÜK.1688



1/1



1/1

1/2

MASING – 13 cm
ÜK.1689



1/2

JOSEPH – 17.5 cm
ÜK.1690



1/2

CONVERSE – 15 cm
ÜK.1691



1/2

COTTLE – 15 cm
ÜK.1692



1/1



1/2

JOSEPH – 14 cm
ÜK.1693



1/1



1/2

COTTLE – 14 cm
ÜK.1694



1/1



FREER – 19 cm
Sivri/Sharp
ÜK.1695



FREER – 19 cm
Künt/Blunt
ÜK.1696



FREER – 18.7 cm
Yana Doğru Eğri
Curved Sidewards
ÜK.1697

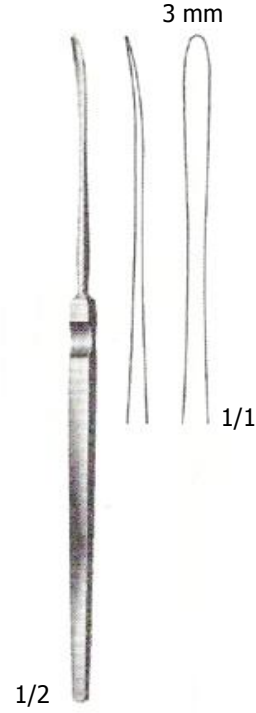

HALLE – 18 cm
Künt/Blunt
ÜK.1698

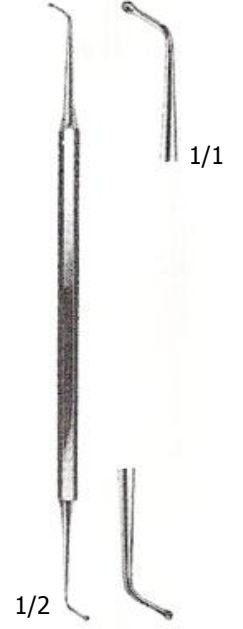

17 cm
ÜK.1699

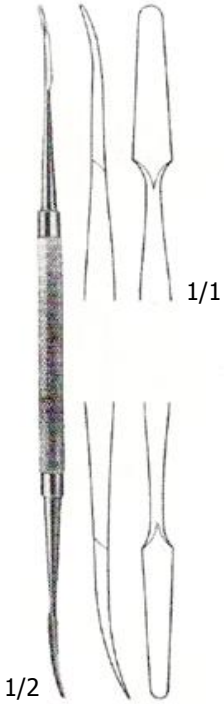

KILLIAN – 18.5 cm
Sivri/Sharp
Künt/Blunt
ÜK.1700

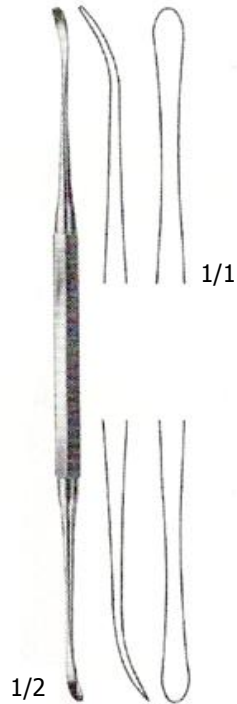

FREER – 18.5 cm
Sivri/Sharp
Künt/Blunt
ÜK.1701

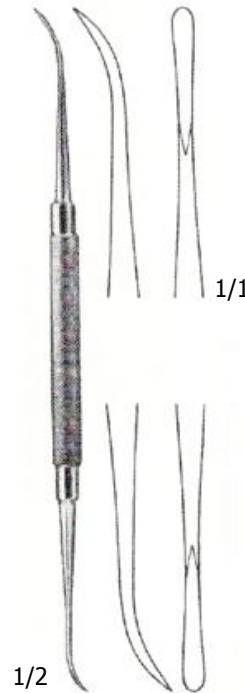

FREER-YASARGIL – 18.5 cm
Sivri/Sharp
Künt/Blunt
ÜK.1702



FREER – 17.5 cm
Sivri/Sharp
Künt/Blunt
ÜK.1703

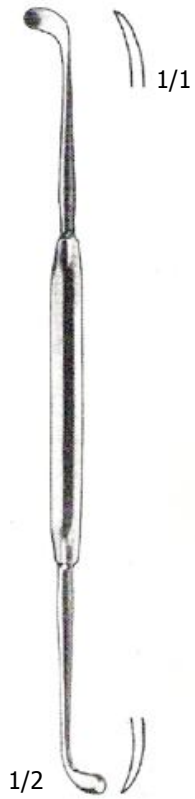

1/2
PENNINGTON – 21 cm
Sivri/Sharp
Sivri/Sharp
ÜK.1704



1/2
PIERCE – 21 cm
Sivri/Sharp
Sivri/Sharp
ÜK.1705



1/2
MASING – 20 cm
Sivri/Sharp
Künt/Blunt
ÜK.1706



1/2
COTTLE – 20 cm
Sivri/Sharp
Sivri/Sharp
ÜK.1707

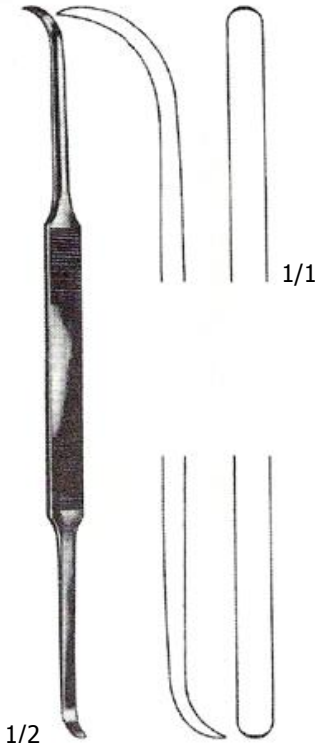

1/2
COTTLE – 20 cm
Sivri/Sharp
Sivri/Sharp
ÜK.1708



1/2
SEWAL – 20 cm
Künt/Blunt
ÜK.1709

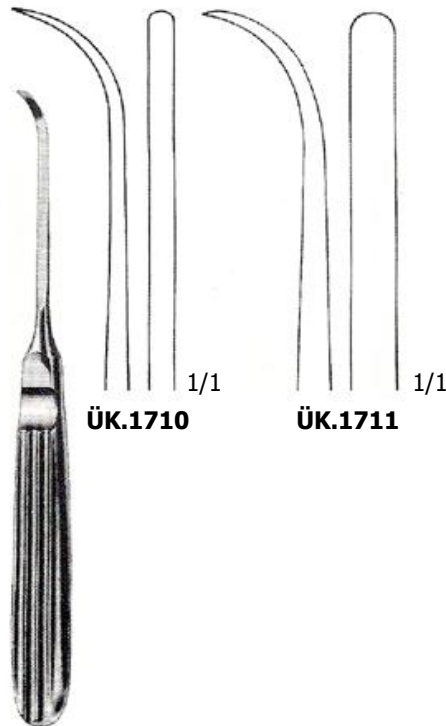

ÜK.1710

ÜK.1711

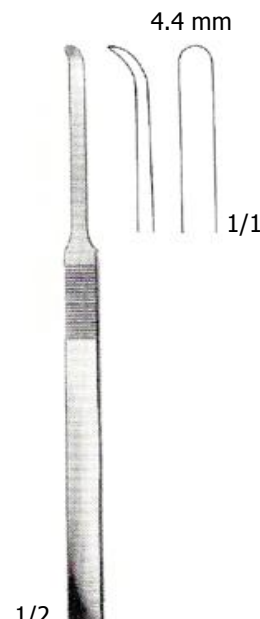

1/2
MC KENTY – 15.5 cm
Sivri/Sharp
ÜK.1712



1/2
VIDAL – 13.5 cm
Sivri/Sharp
ÜK.1713

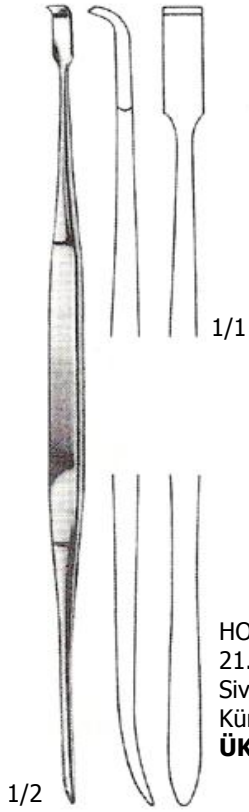

HOWARTH
21.5 cm
Sivri/Sharp
Künt/Blunt
ÜK.1714

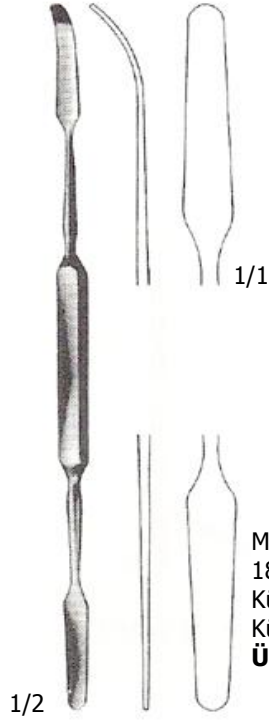

MAC DONALD
18.5 cm
Künt/Blunt
Künt/Blunt
ÜK.1715

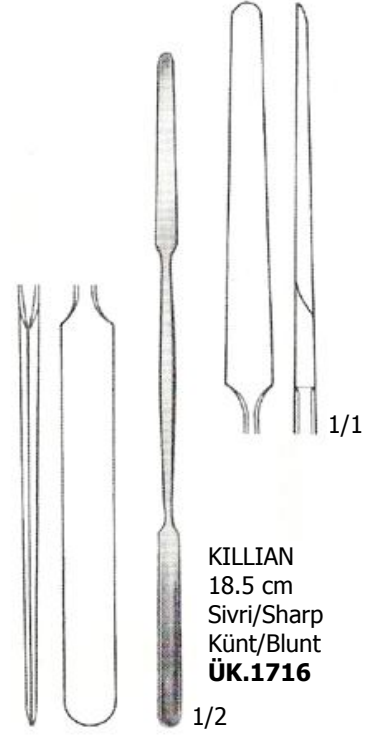

KILLIAN
18.5 cm
Sivri/Sharp
Künt/Blunt
ÜK.1716

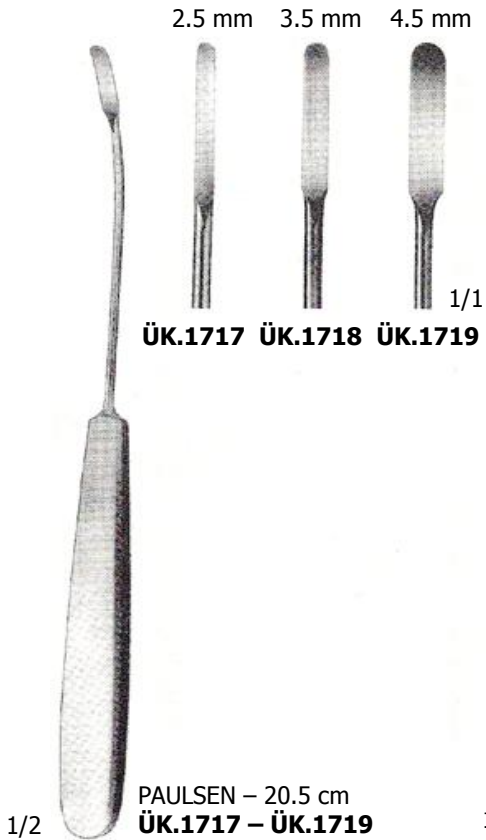

PAULSEN – 20.5 cm
ÜK.1717 – ÜK.1719

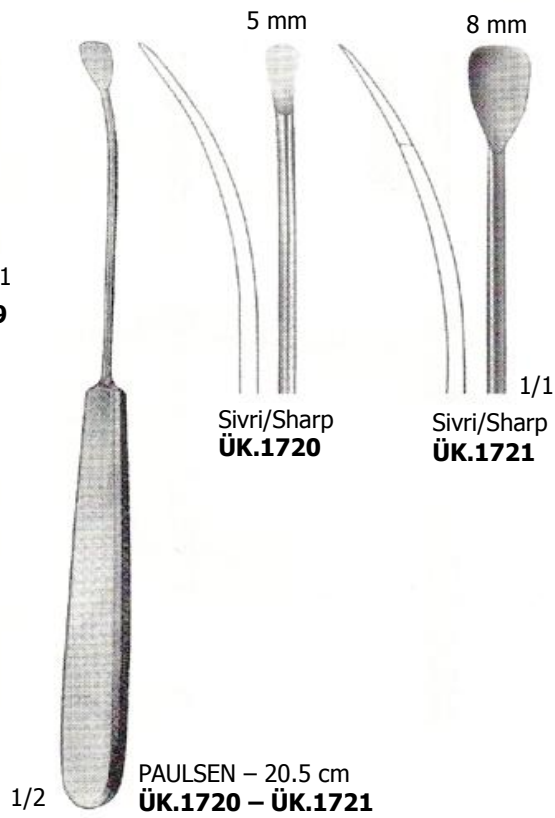

PAULSEN – 20.5 cm
ÜK.1720 – ÜK.1721

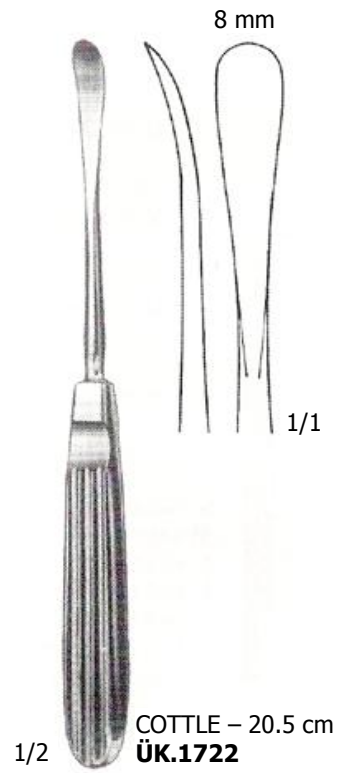

COTTLE – 20.5 cm
ÜK.1722

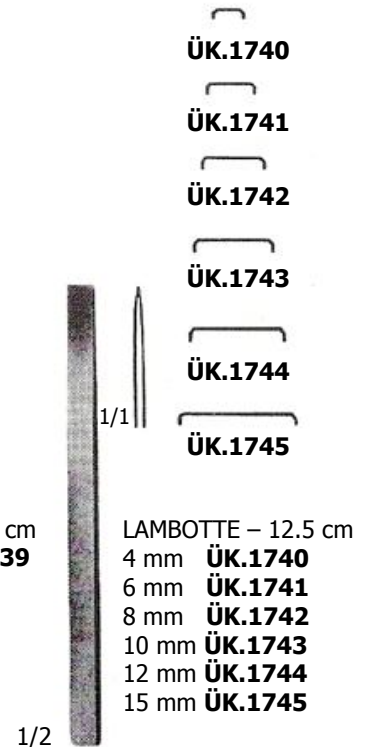
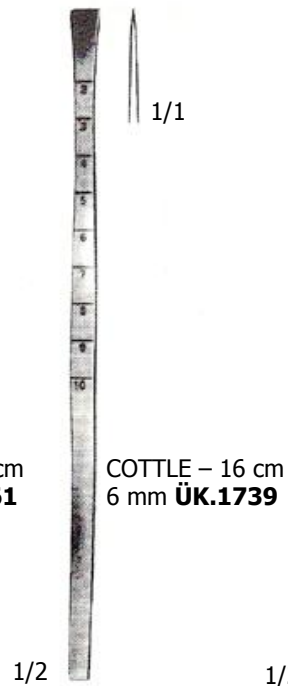
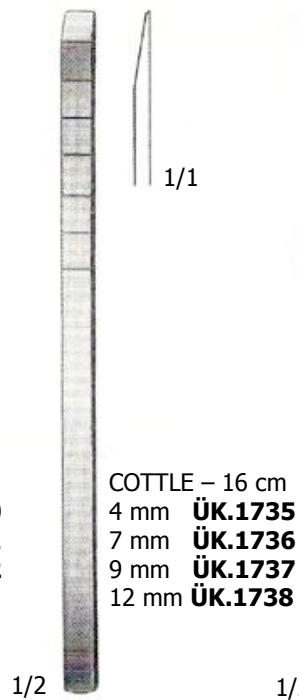
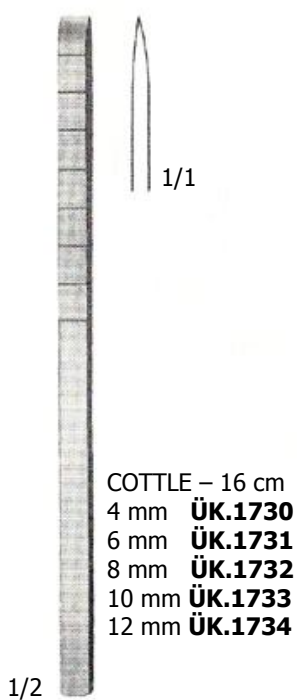
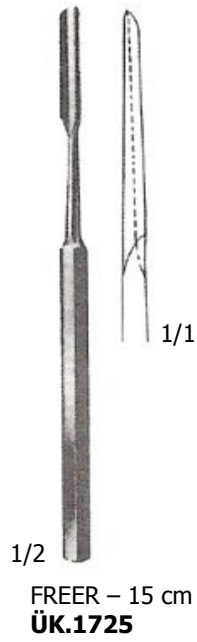
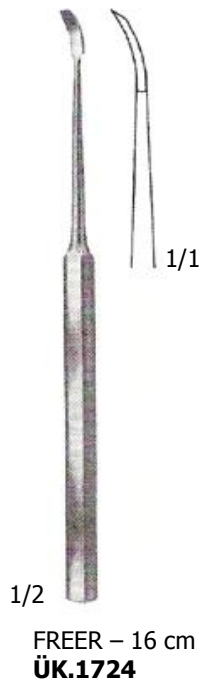
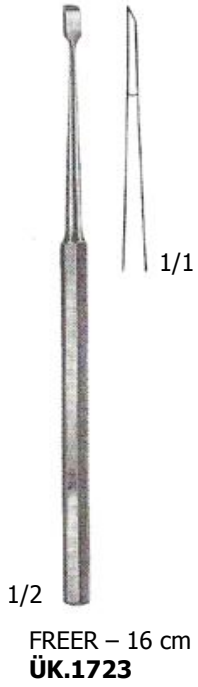

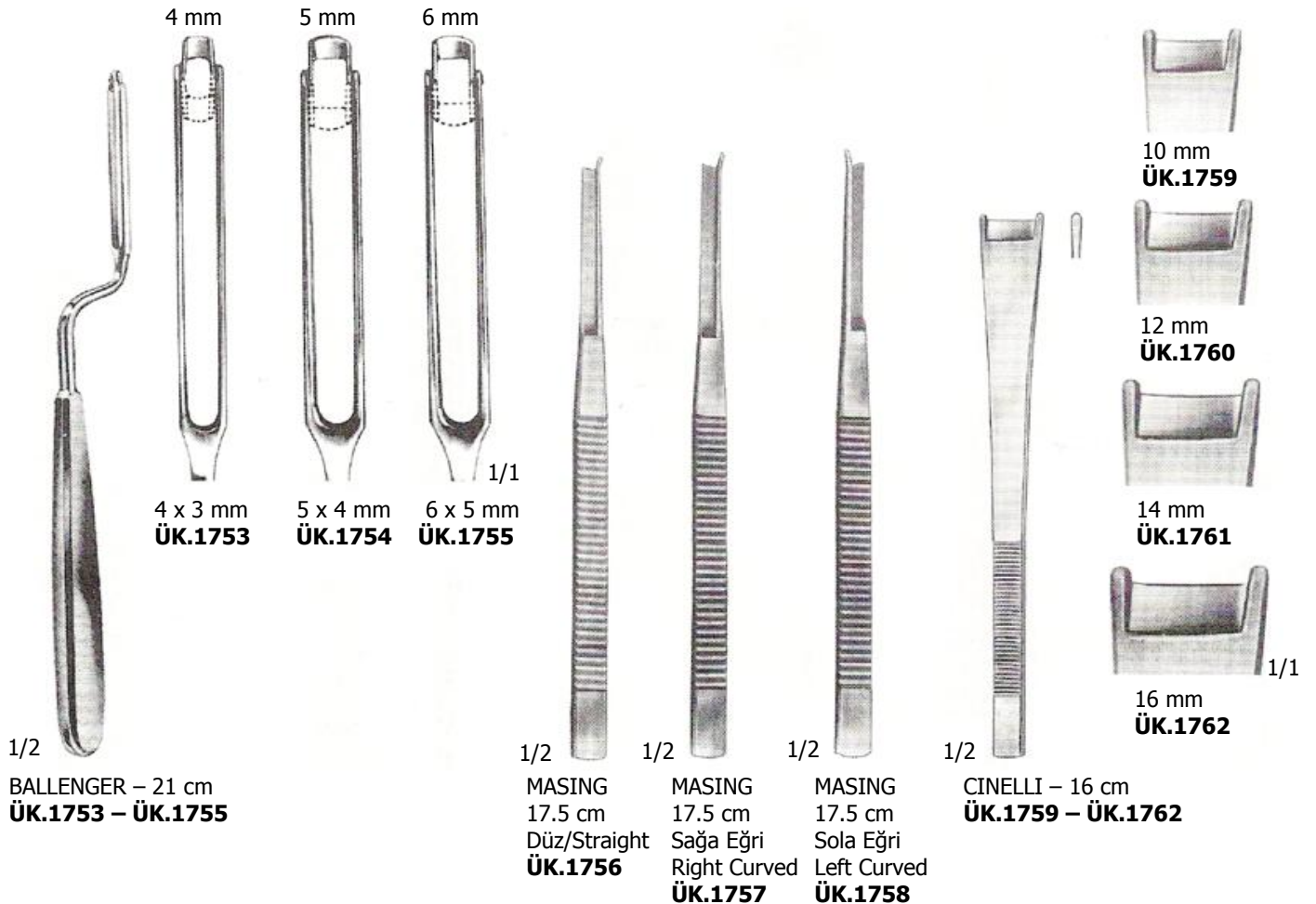
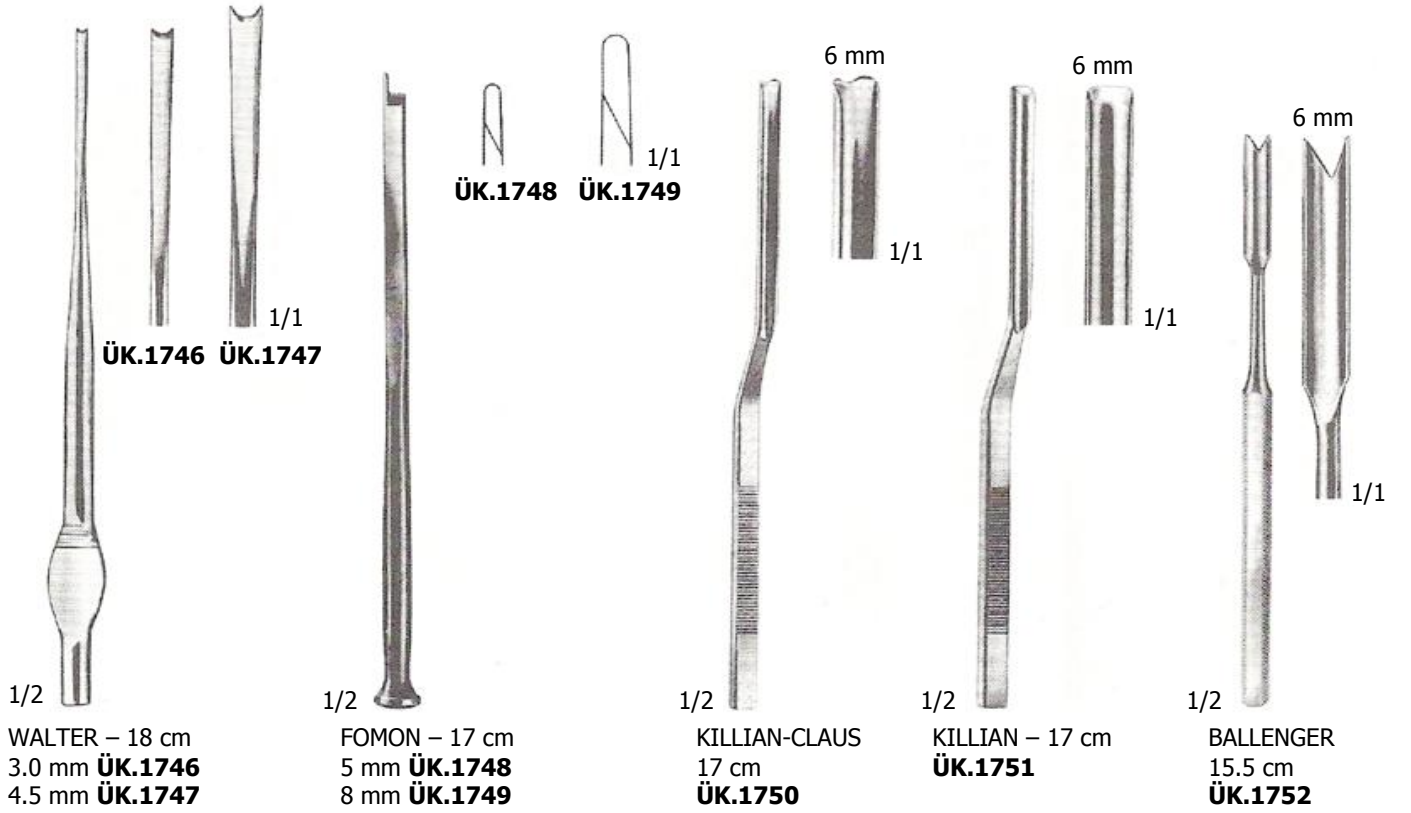

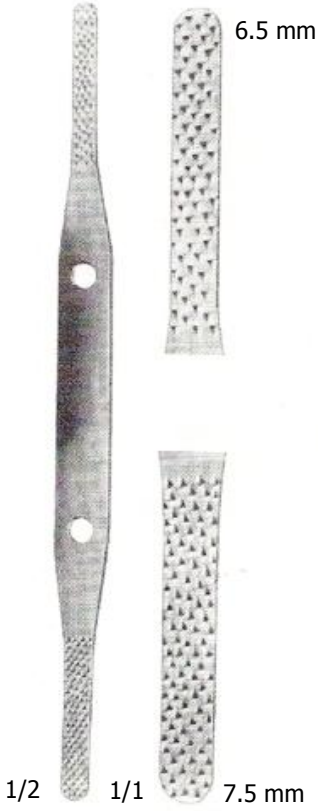

FOMON – 21.5 cm
ÜK.1763

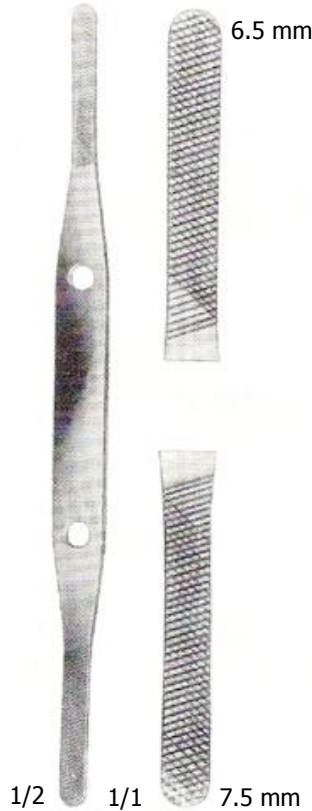

FOMON – 21.5 cm
ÜK.1764

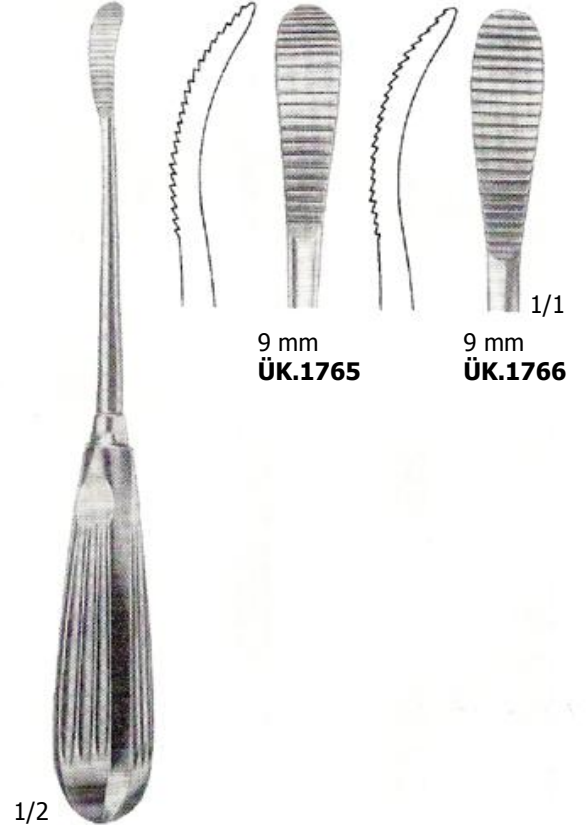

AUFRICH – 22 cm
Diş Ağzları Yukarı Doğru/Up Stroke **ÜK.1765**
Diş Ağzları Aşağı Doğru/Down Stroke **ÜK.1766**



JOSEPH – 16.5 cm
İnce Dişli/Fine Teeth **ÜK.1767**
Kalın Dişli/Coarse Teeth **ÜK.1768**

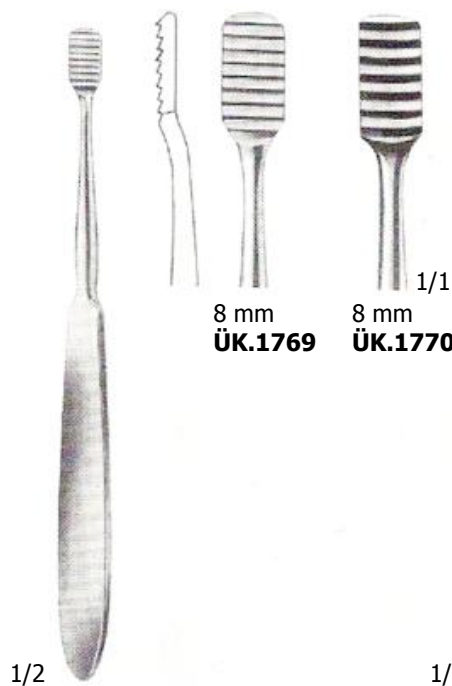

LEWIS – 17.5 cm
İnce Dişli/Fine Teeth **ÜK.1769**
Kalın Dişli/Coarse Teeth **ÜK.1770**

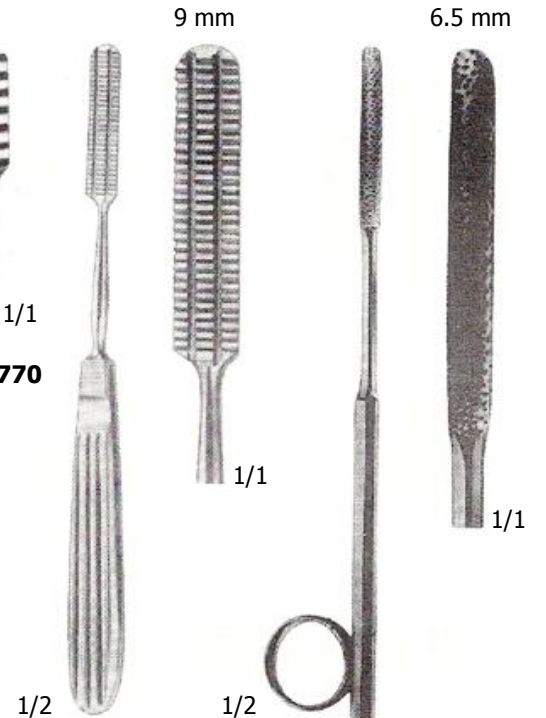

MALTZ – 18 cm
Diş Ağzları Aşağı Doğru/Down Stroke **ÜK.1771**
GALLAHER – 19 cm
ÜK.1772

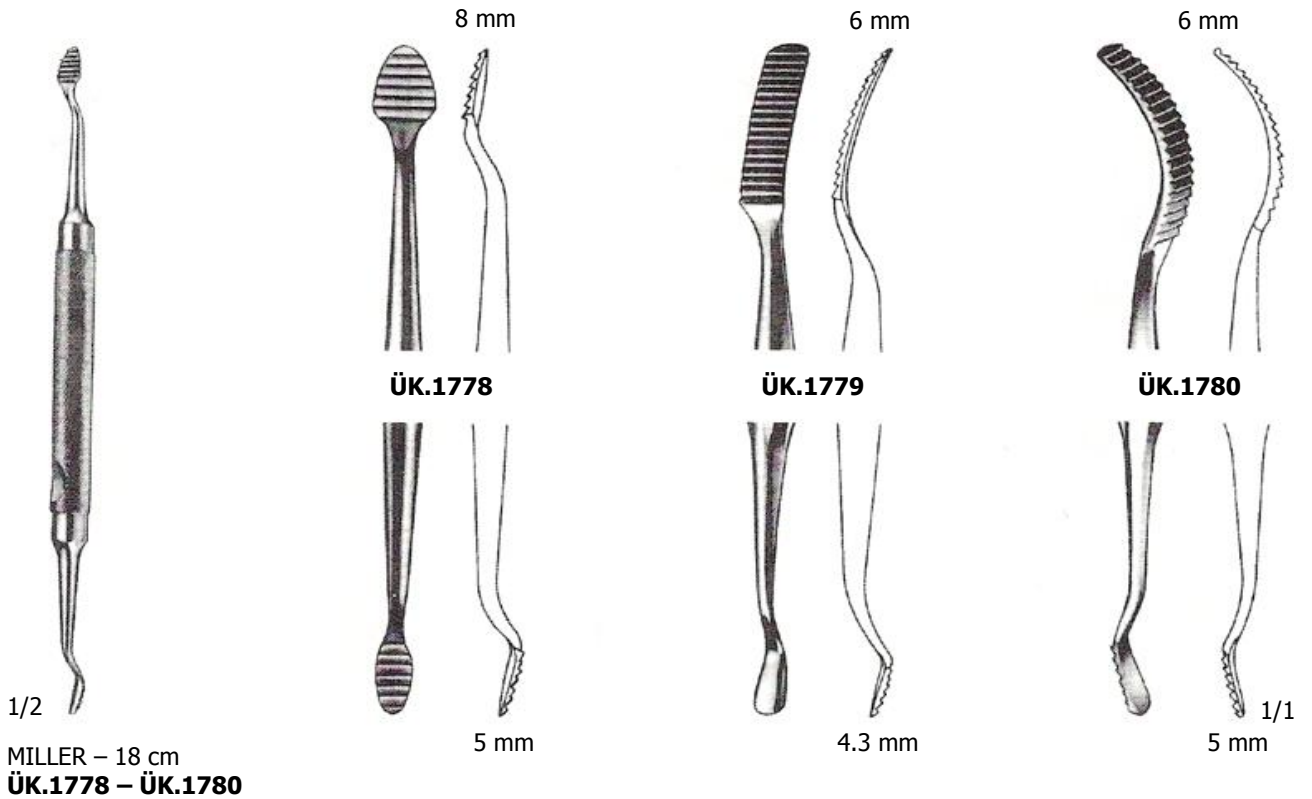
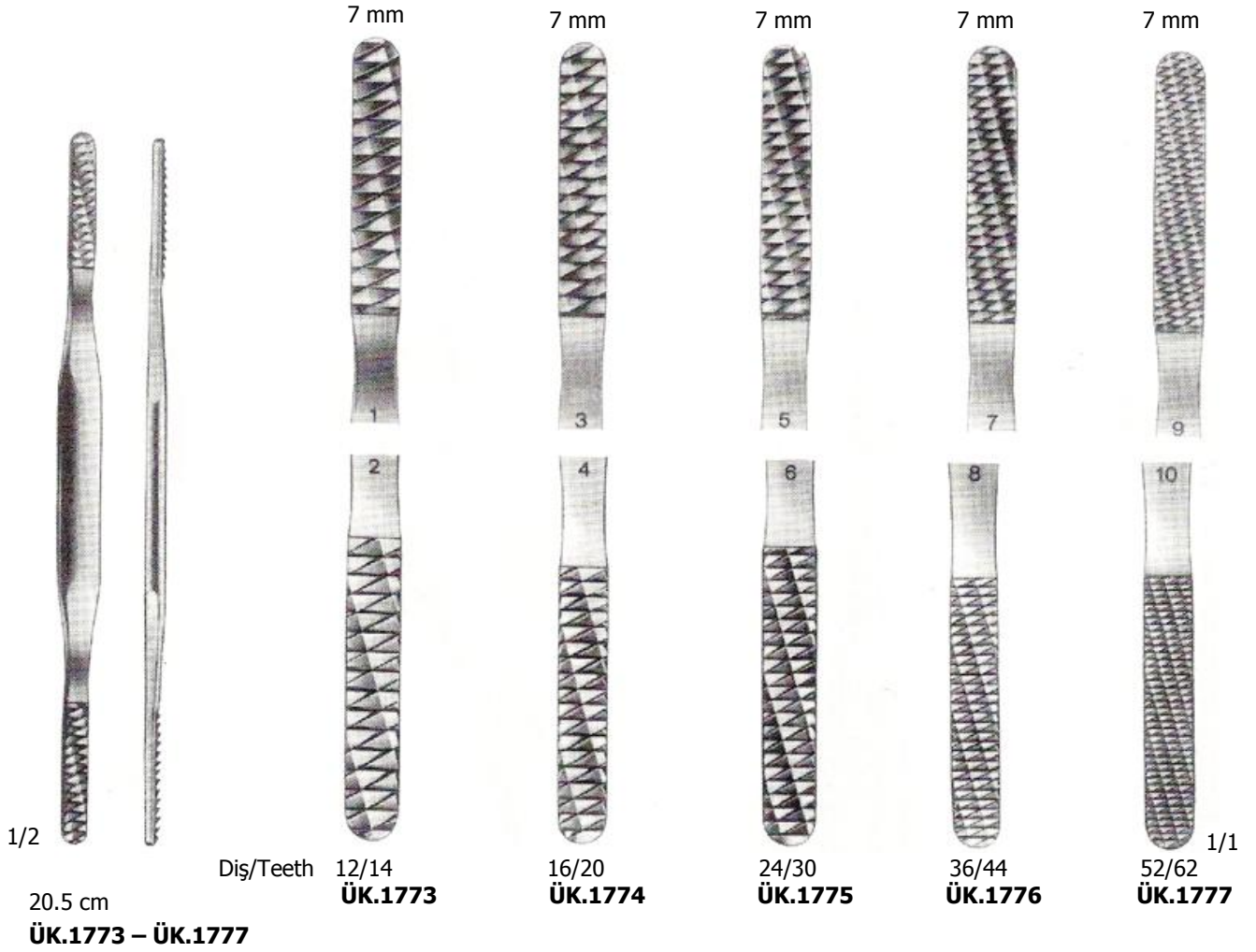

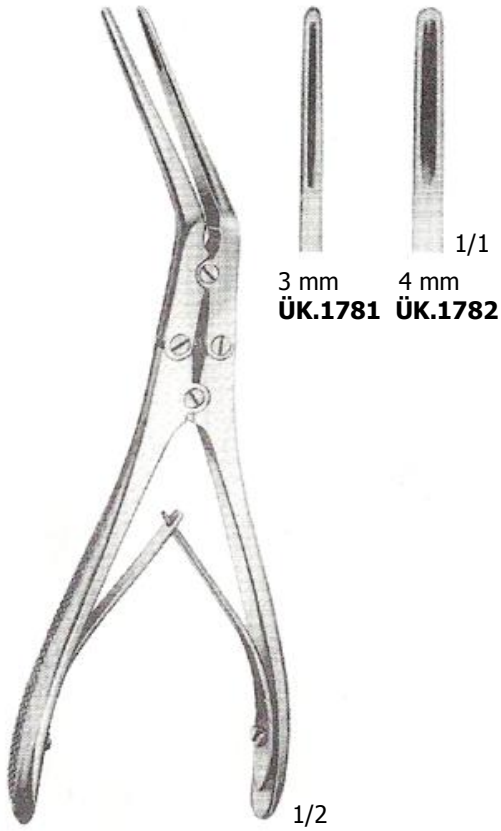

KRESSNER – 22 cm
ÜK.1781 – ÜK.1782



JANSEN-MIDDLETON – 21 cm
ÜK.1783

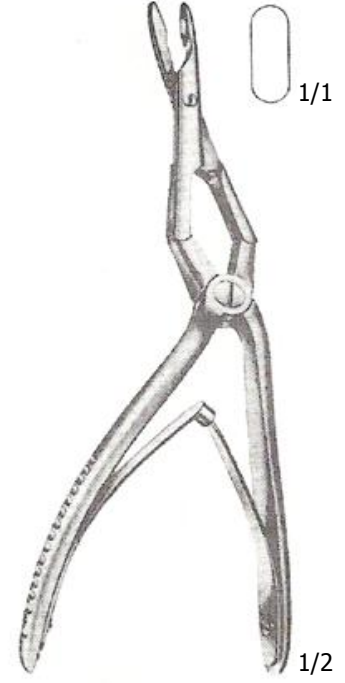

JANSEN-MIDDLETON – 20 cm
ÜK.1784



COTTLE-WALSHAM – 22 cm
ÜK.1785



GOLDMAN – 20 cm
ÜK.1786



BOIES – 18 cm
ÜK.1787

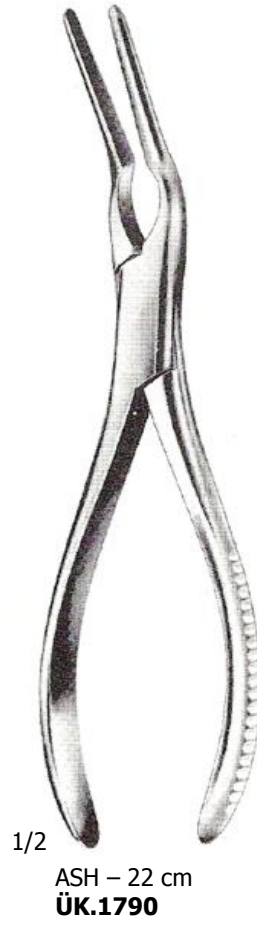

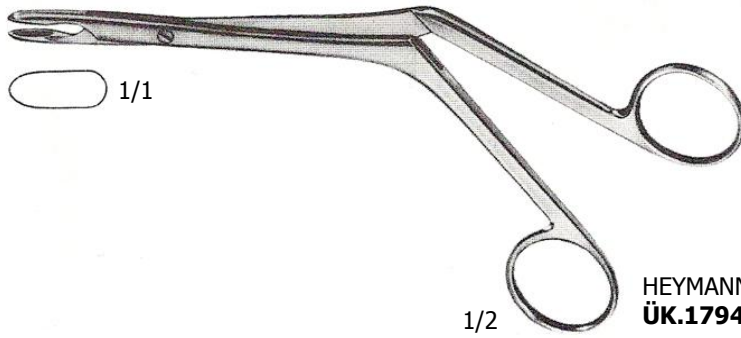

HEYMANN-KNIGHT – 19 cm
ÜK.1794



HEYMANN – 18 cm
ÜK.1795

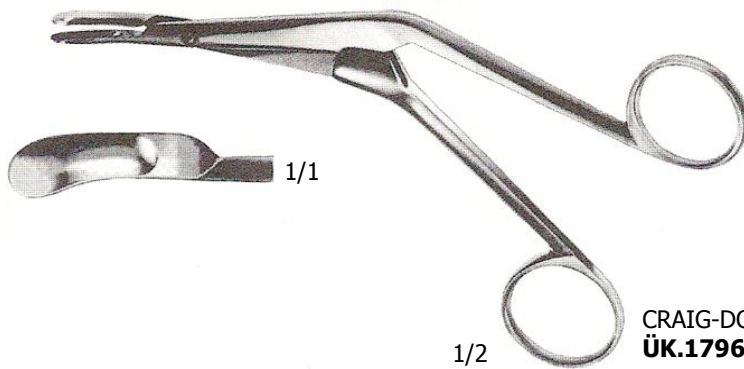

CRAIG-DOMNICK – 16.5 cm
ÜK.1796

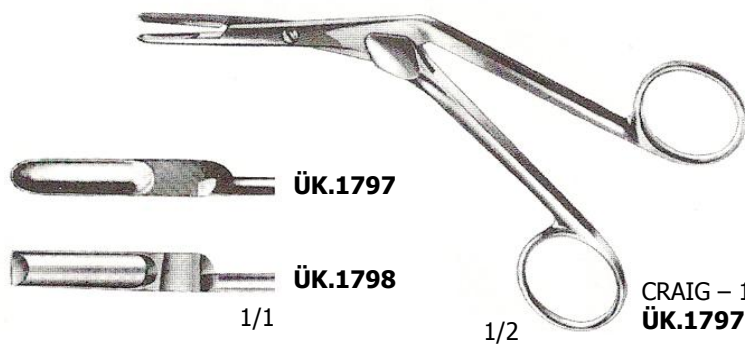

ÜK.1797

ÜK.1798

CRAIG – 16.5 cm
ÜK.1797 – ÜK.1798

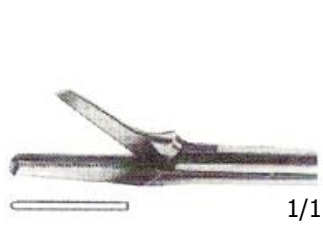

STRUYCKEN
ÜK.1799

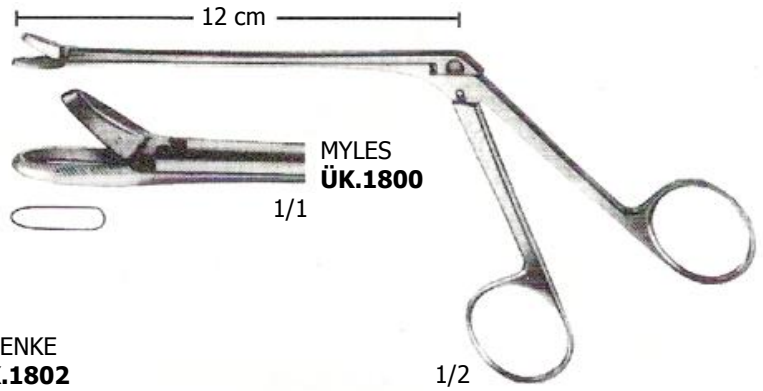

MYLES
ÜK.1800

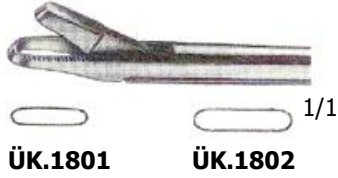

GRUENWALD-HENKE
ÜK.1801 – ÜK.1802

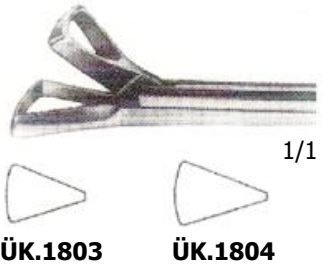

SCHMEDEN
ÜK.1803 – ÜK.1804



HARTMANN
ÜK.1805 – ÜK.1808

ÜK.1805

ÜK.1806

ÜK.1807

ÜK.1808

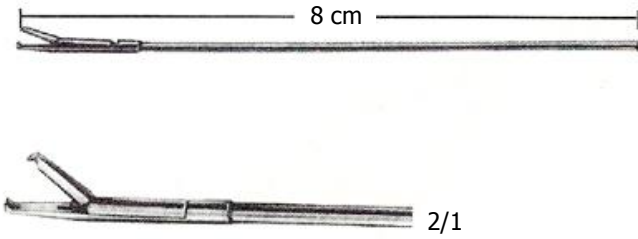

1 x 2 Dis/Teeth
ÜK.1809

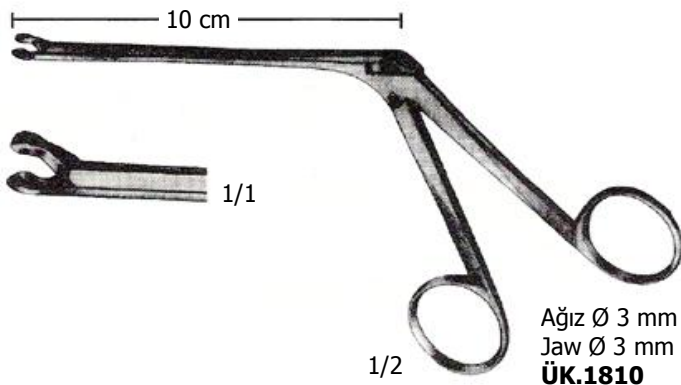

Ağız Ø 3 mm
Jaw Ø 3 mm
ÜK.1810

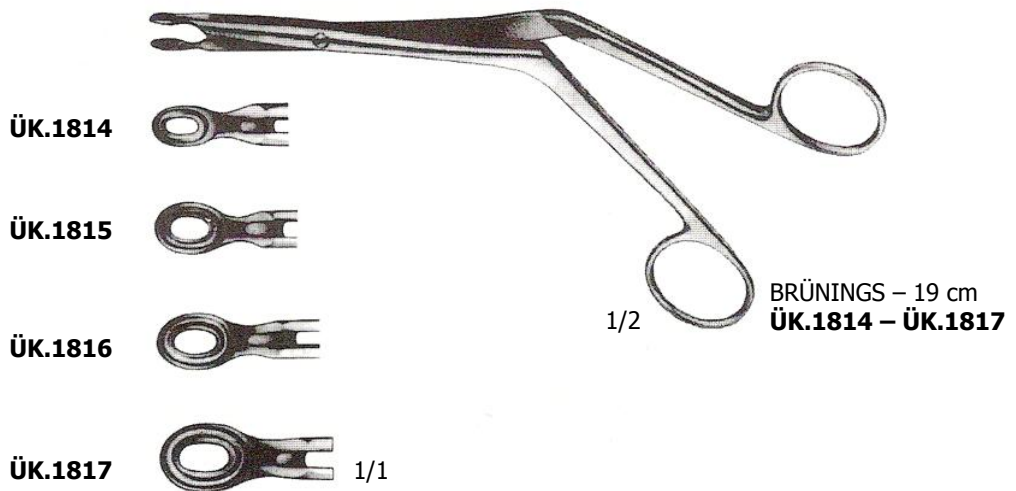
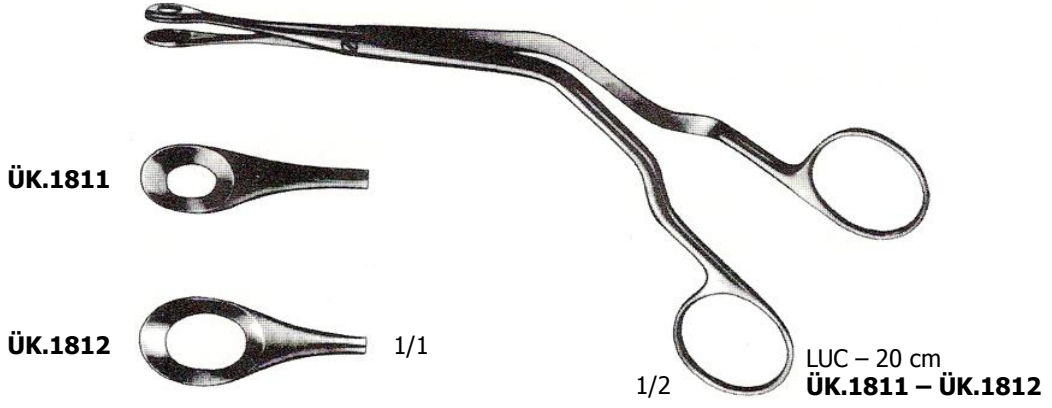

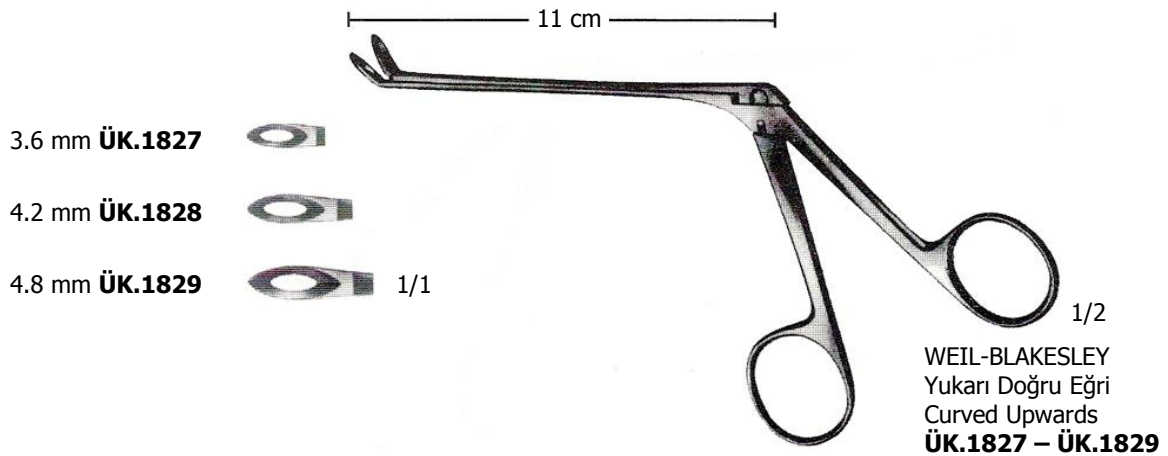
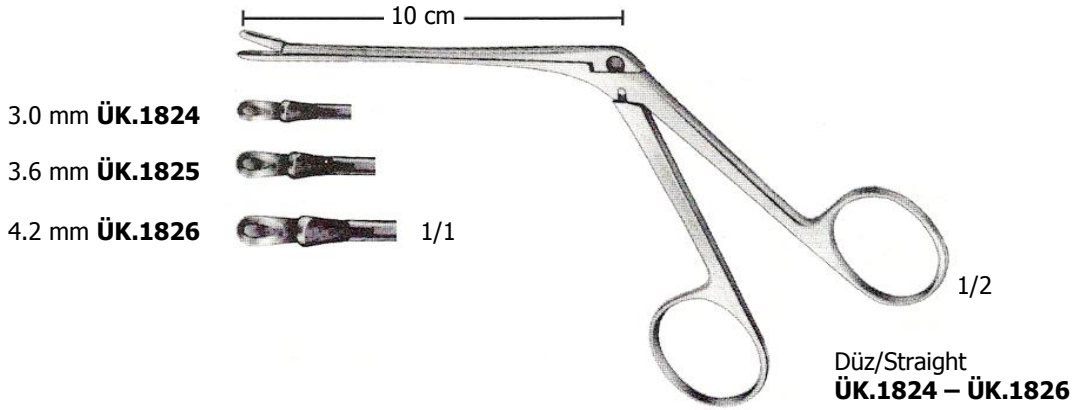
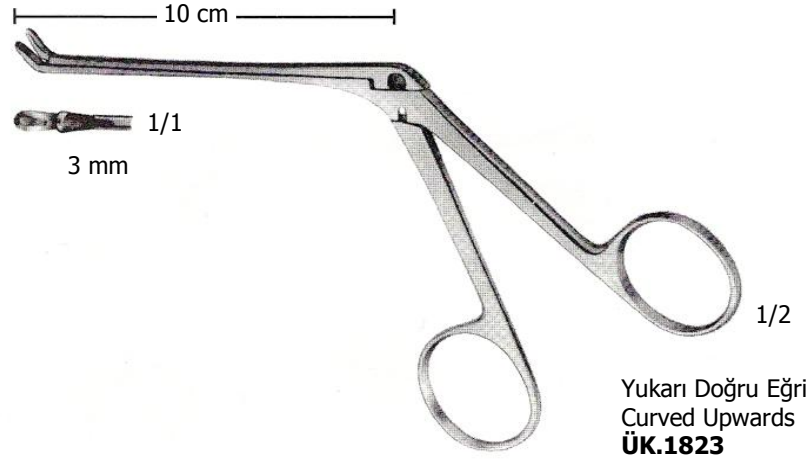
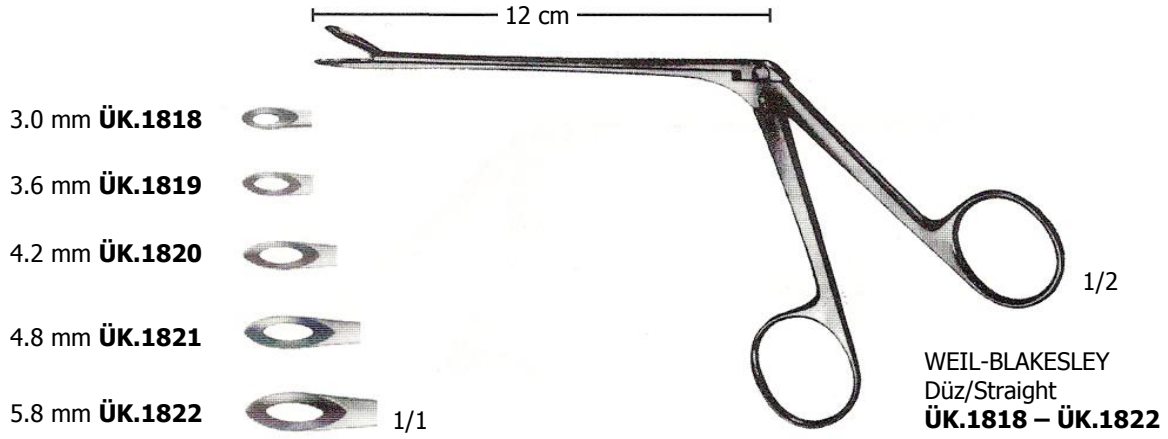

5 mm ÜK.1830



7 mm ÜK.1831



9 mm ÜK.1832

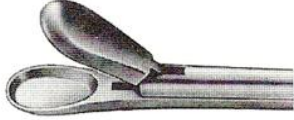

1/1

12 cm

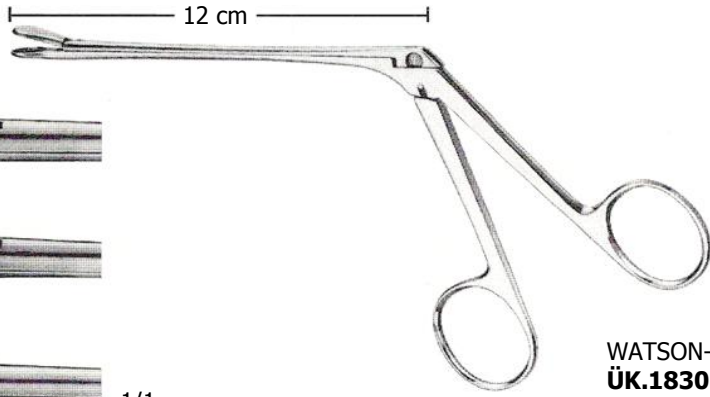

1/2

WATSON-WILLIAMS
ÜK.1830 – ÜK.1832

12 cm

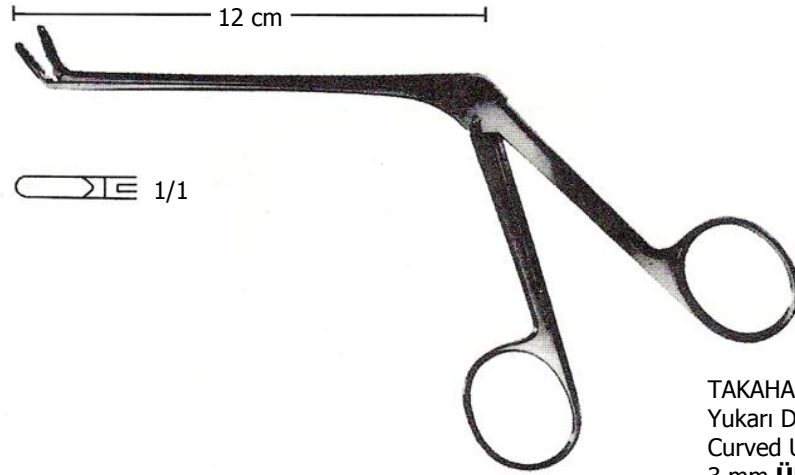

1/2

TAKAHASHI
Yukarı Doğru Eğri
Curved Upwards
3 mm ÜK.1833

1/1

12 cm

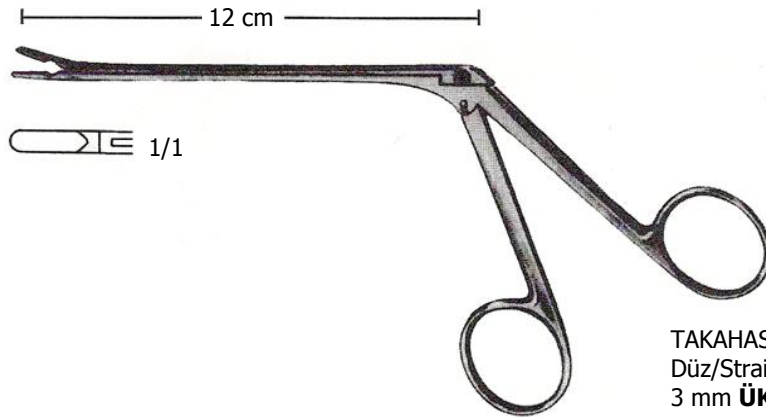

1/2

TAKAHASHI
Düz/Straight
3 mm ÜK.1834

1/1

12 cm

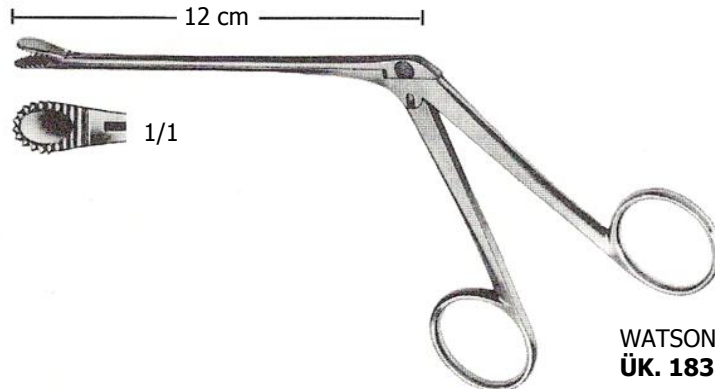

1/2

WATSON-WILLIAMS
ÜK. 1835

1/1

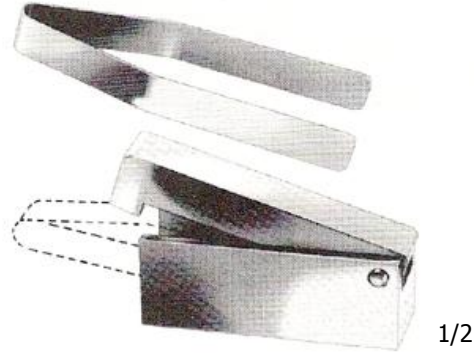

ÜK. 1836

11.5 cm
Bleyd Uzunluğu
Length Of Blade



1/2

LANGENBECK
23.5 cm
Düz/Straight
ÜK. 1837



1/2

JOSEPH – 17 cm
Düz/Straight
ÜK. 1838



1/2

JOSEPH – 17 cm
Sola Doğru Eğri
Curved To Left
ÜK. 1839



1/2

JOSEPH – 17 cm
Sağa Doğru Eğri
Curved To Right
ÜK. 1840

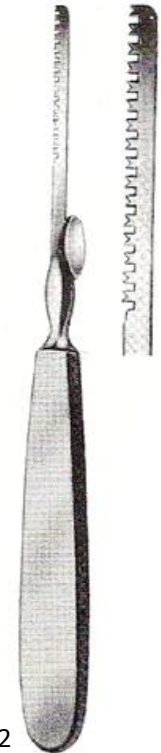

1/2

LINDEMANN – 20 cm
Düz/Straight
ÜK. 1841



4. BÖLÜM

SİNÜS VE HİPOFİZEKTOMİ Sinus and Hypophysectomy

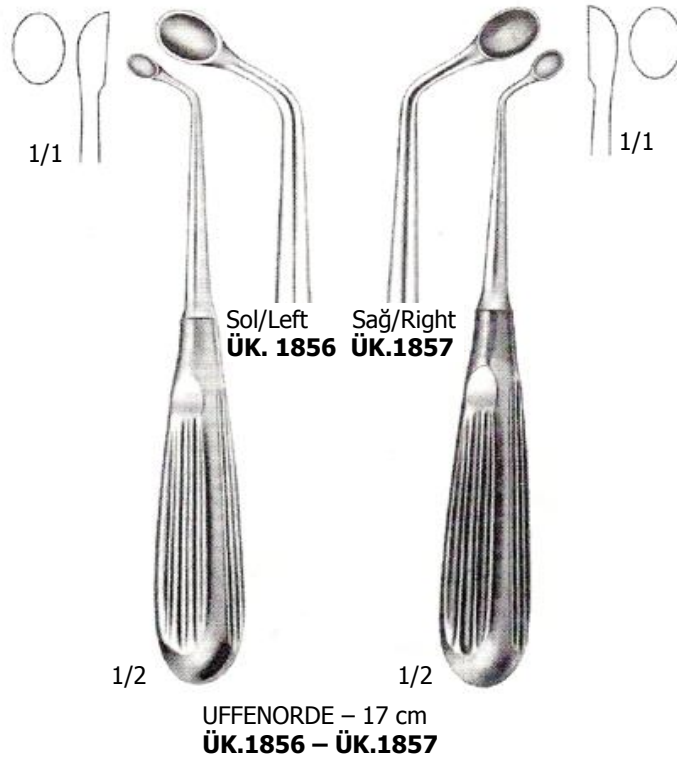
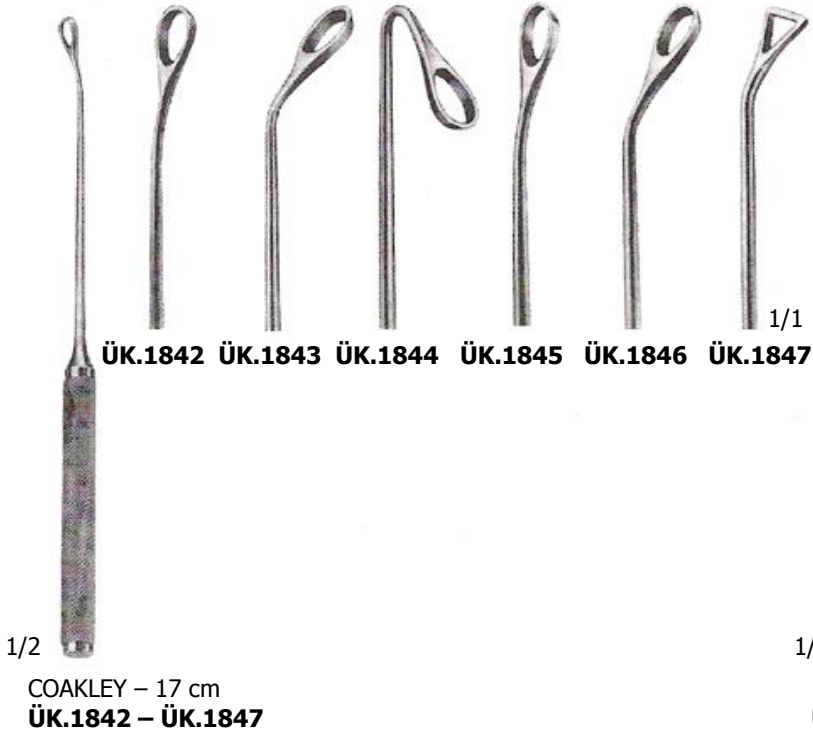

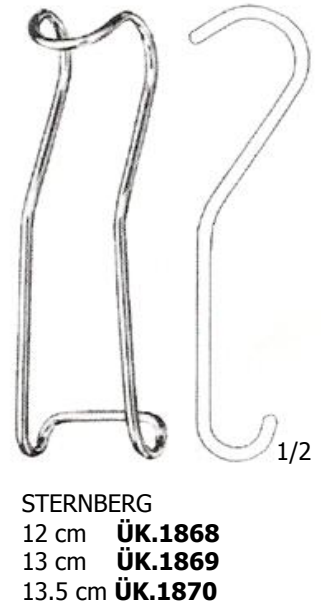
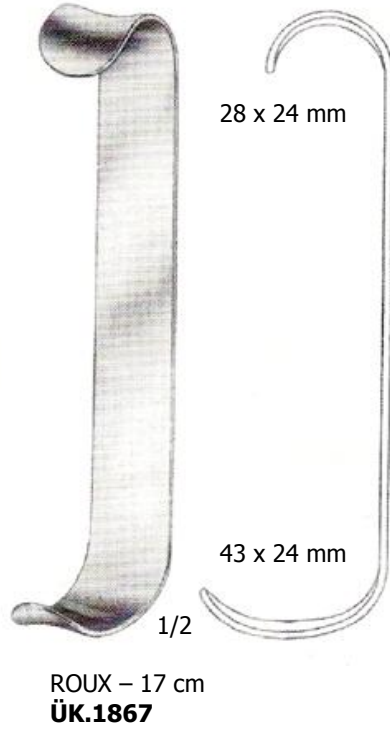
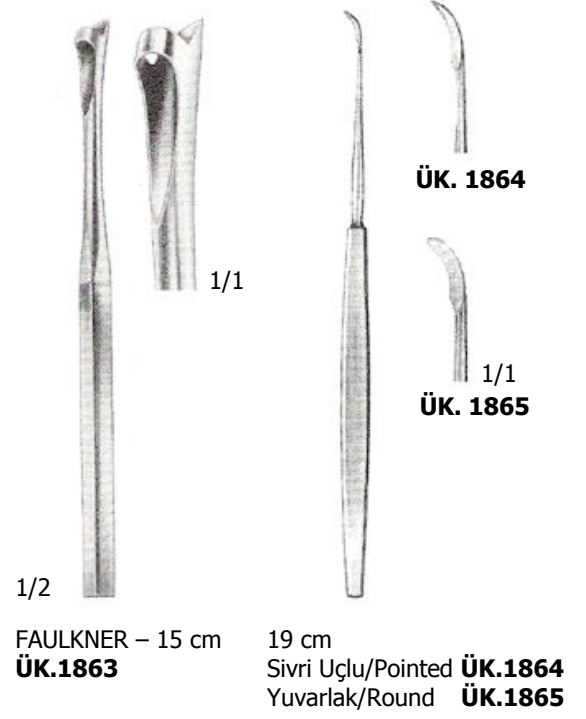
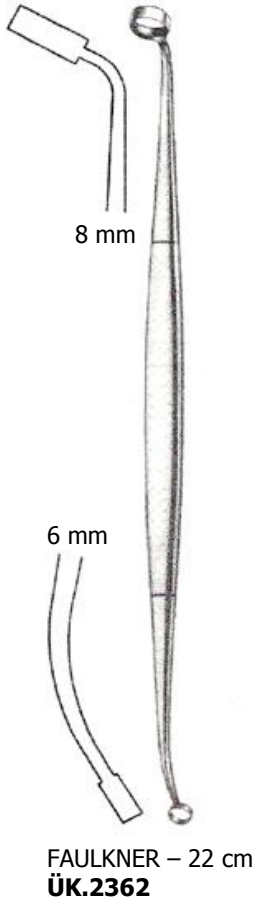

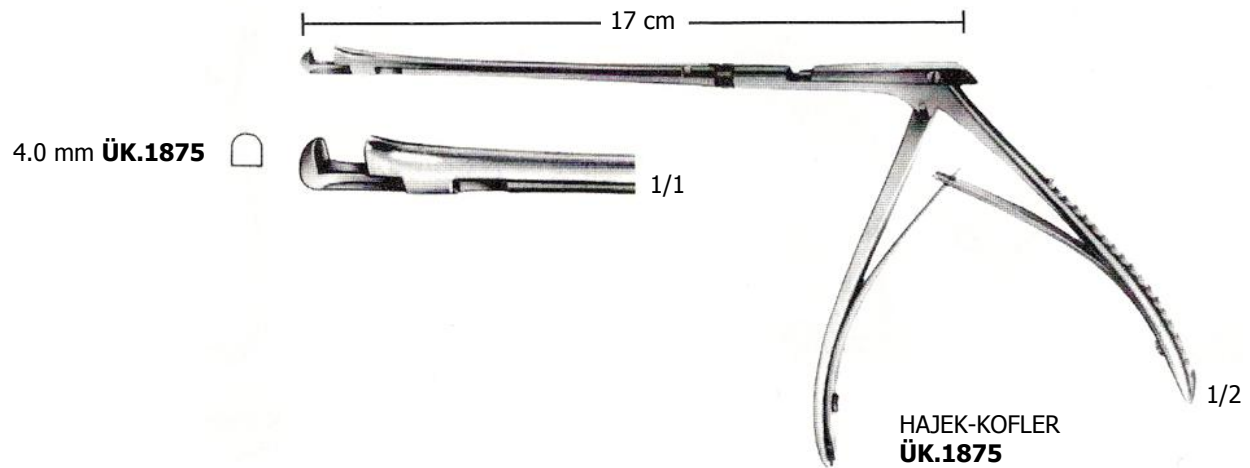
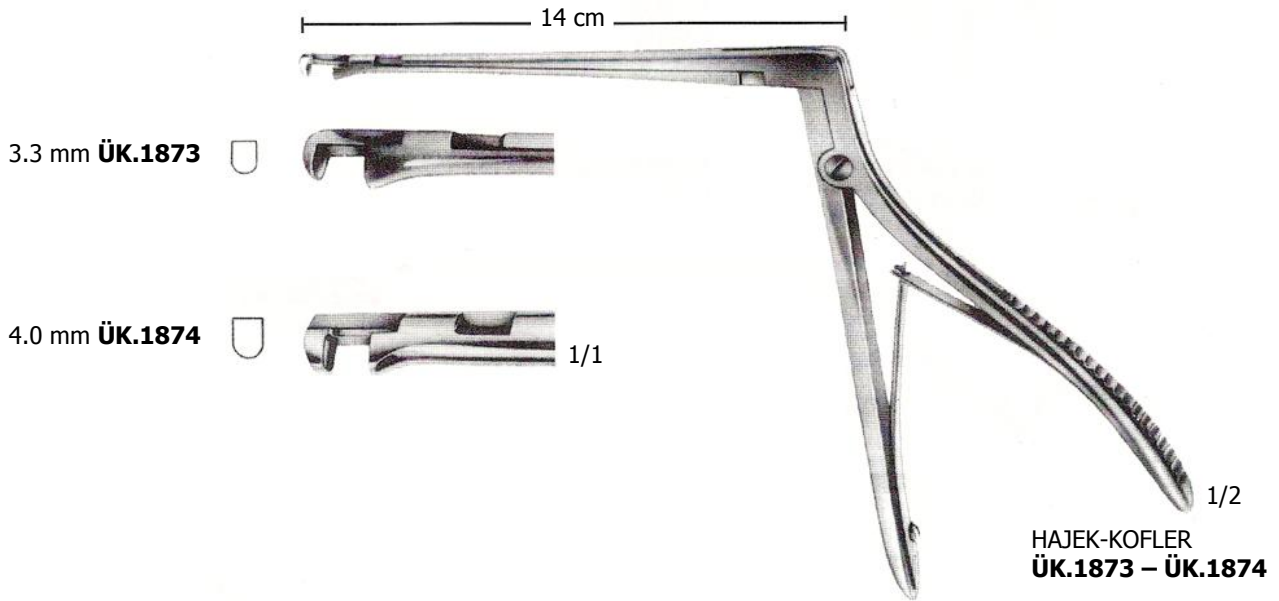
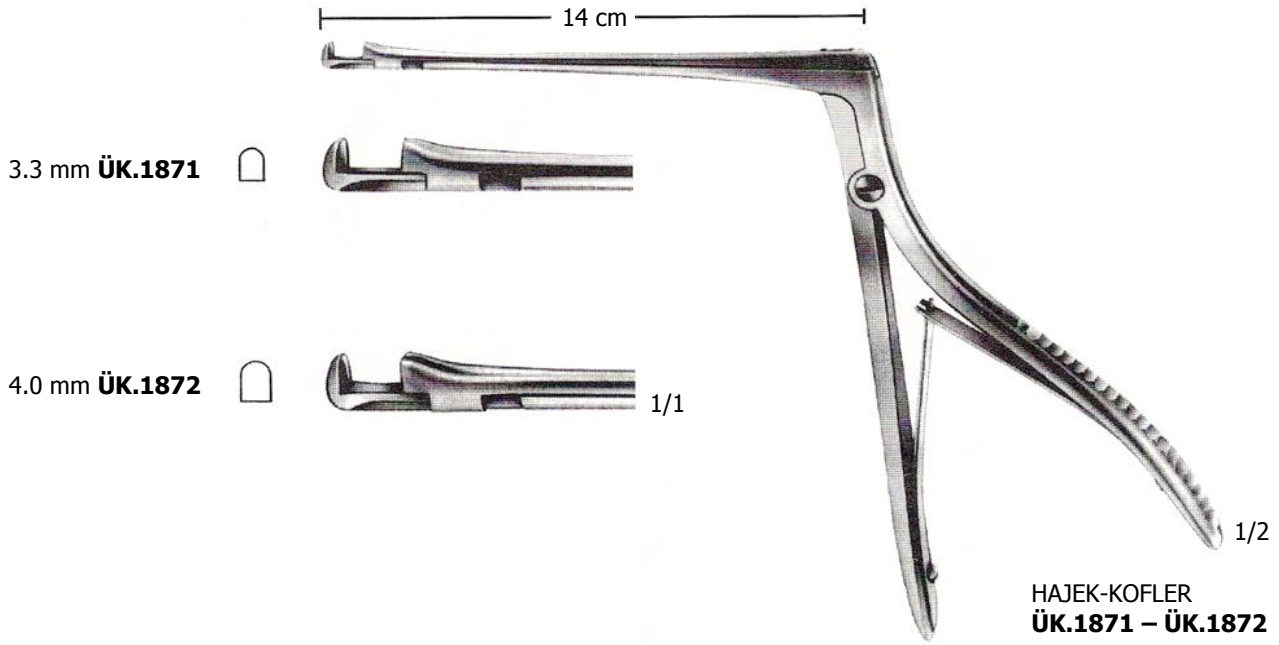

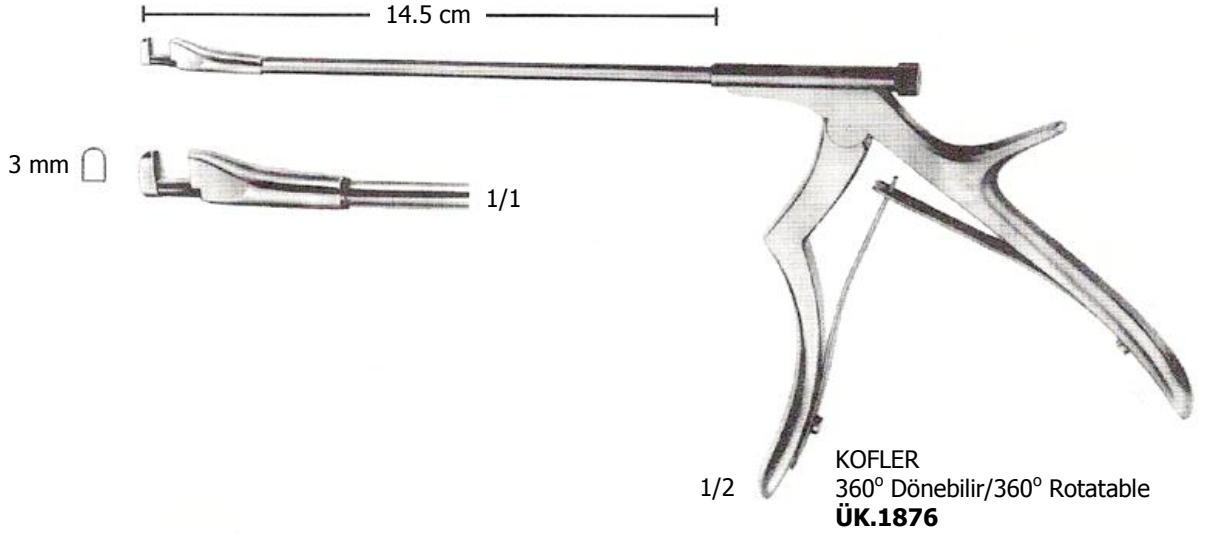

OSTROM
Geriye Doğru Keser
Backward Cutting
ÜK.1877



OSTROM
Geriye Doğru Keser
Backward Cutting
ÜK.1878

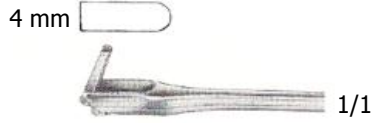

WAGENER
Öne Doğru Keser
Forward Cutting
ÜK.1880

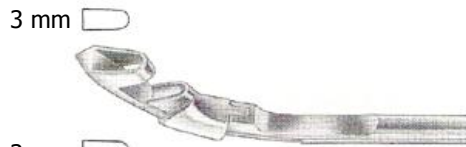

WAGENER
Öne Doğru Keser
Forward Cutting
ÜK.1881





1/1

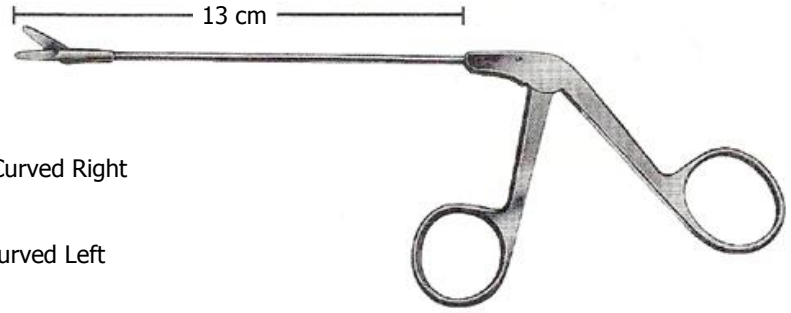

1/1

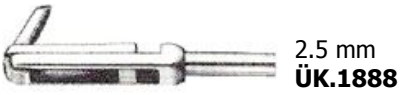
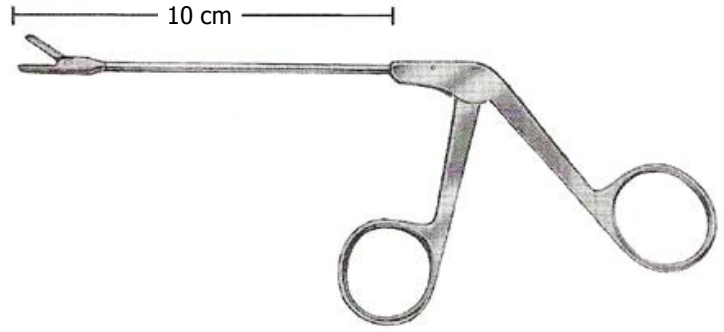

1/1

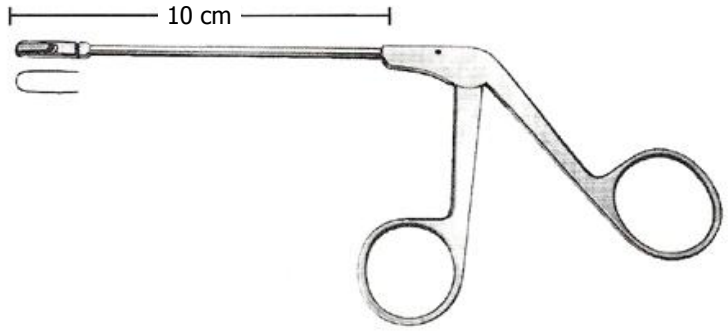

1/1

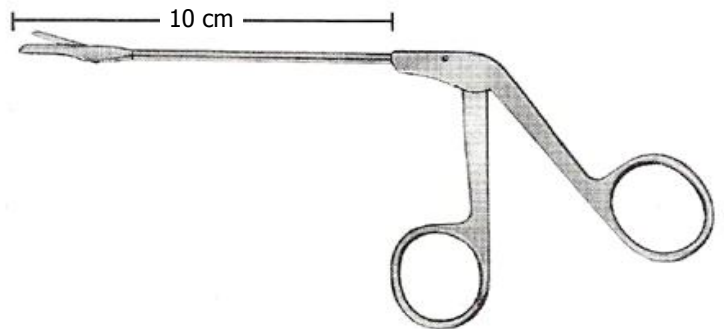



BLAKESLEY



3.6 mm
ÜK.1892



5.0 mm
ÜK.1893



BLAKESLEY
4.2 mm ÜK.1894



BLAKESLEY-WILDE



3.6 mm
ÜK.1895

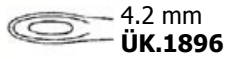

4.2 mm
ÜK.1896



5.0 mm
ÜK.1897



STRÜMPEL-VOSS
3.6 mm ÜK.1898



KENNEDY-BLAKESLEY



3.6 mm
ÜK.1899



4.2 mm
ÜK.1900



5.0 mm
ÜK.1901



KENNEDY-BLAKESLEY



3.6 mm
ÜK.1902



4.2 mm
ÜK.1903

WEIL-BLAKESLEY
3.0 mm ÜK.1904



3.6 mm ÜK.1905



4.2 mm ÜK.1906



4.8 mm ÜK.1907



5.8 mm ÜK.1908



1/1

3.6 mm ÜK.1909



4.2 mm ÜK.1910



4.8 mm ÜK.1911



1/1

10 cm

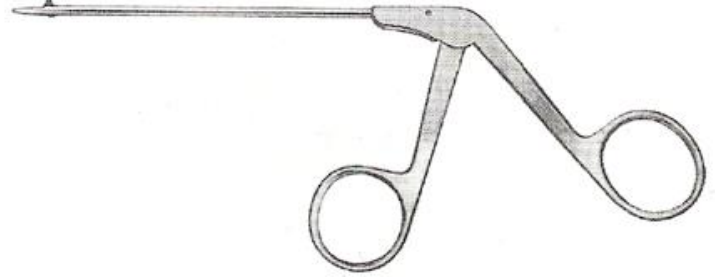

10 cm

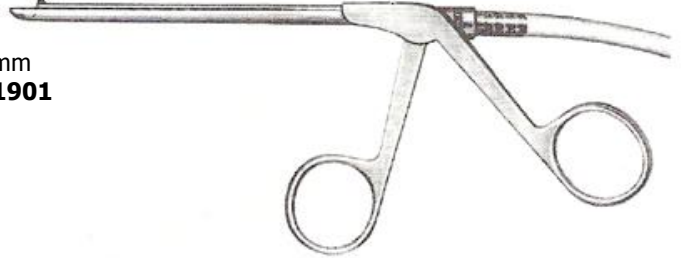

12 cm



1/2

11 cm



1/2

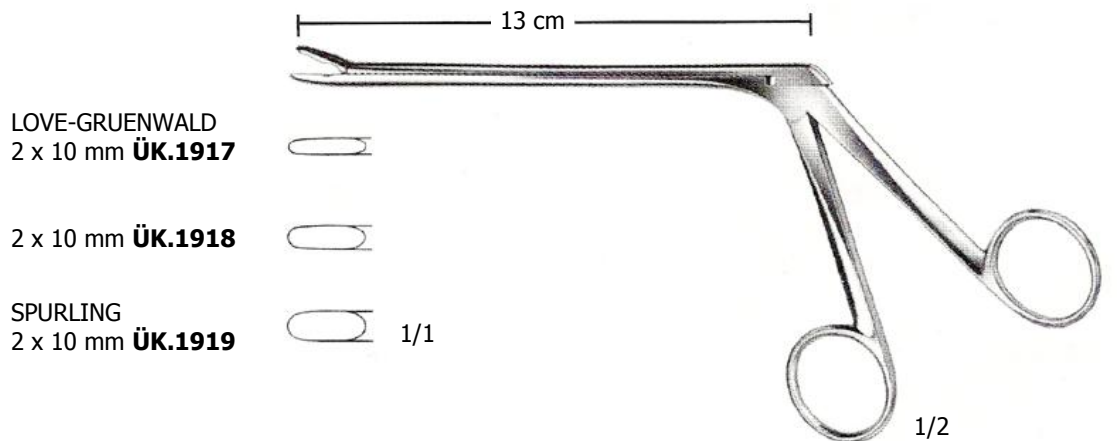
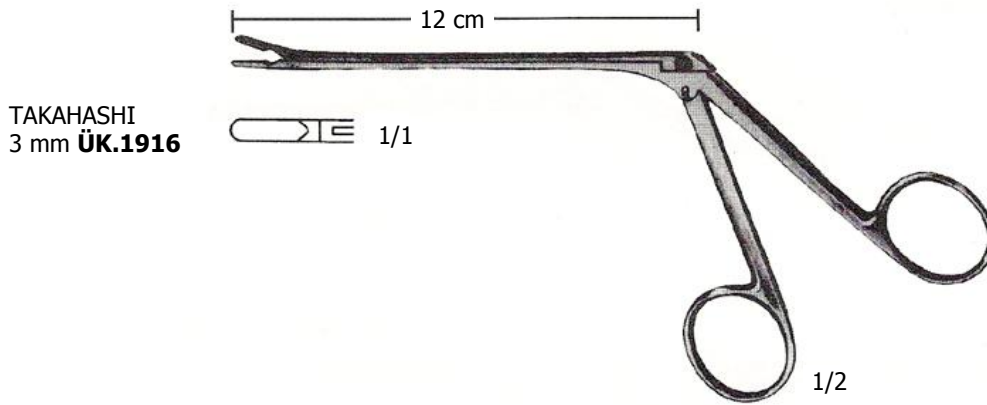
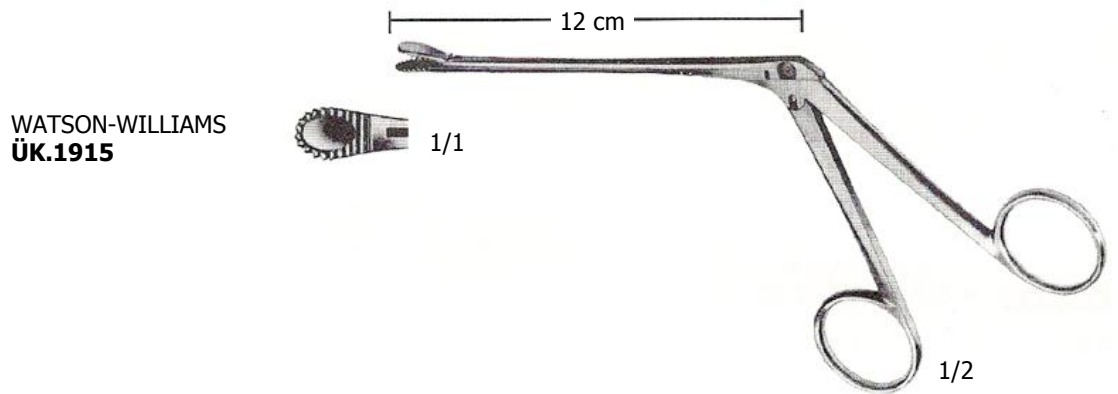
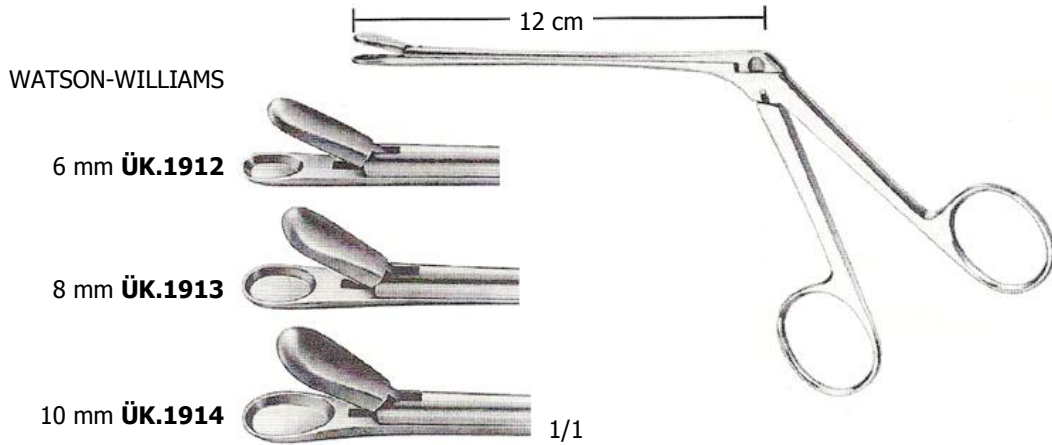

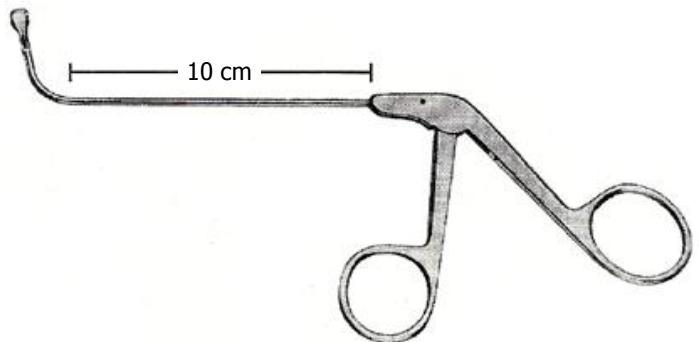
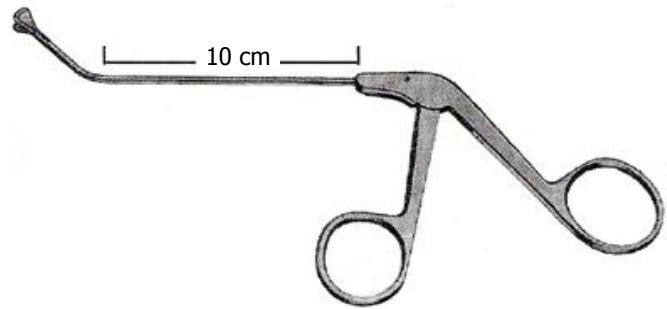
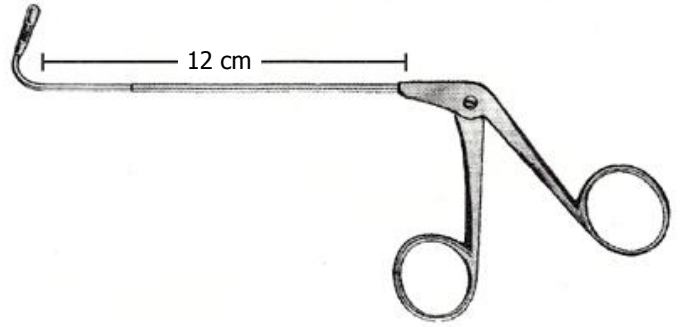
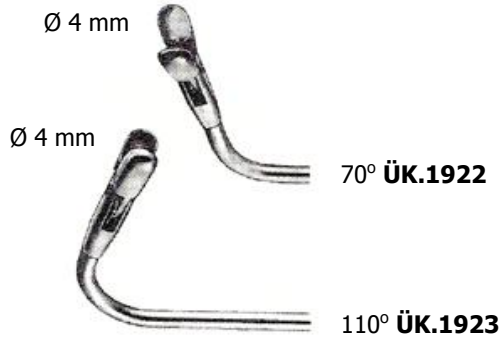
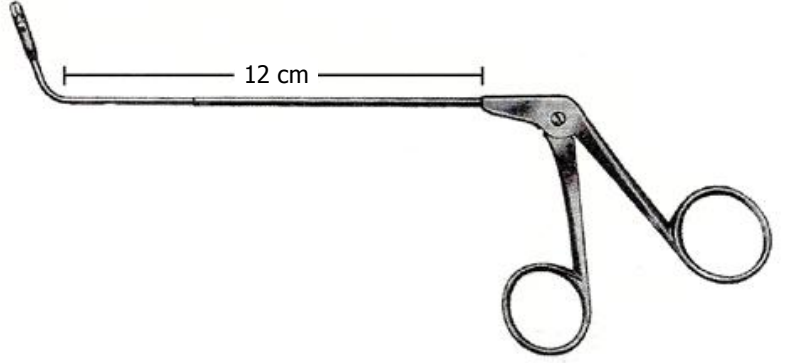
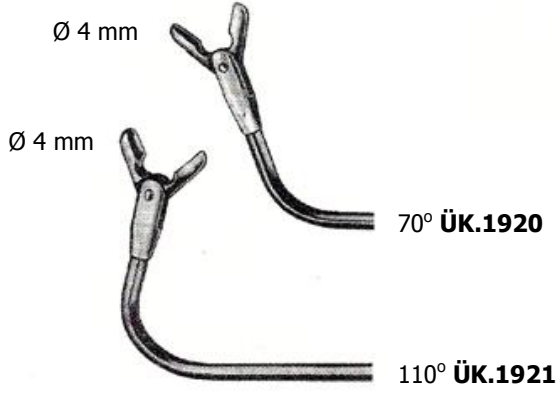



5. BÖLÜM

AĞIZ CERRAHİSİ, ADENOİDEKTOMİ,
TONSİLLEKTOMİ, LARİNGOLOJİ,
BRONKOSKOPI, ÖZOFAGOSKOPI,
TRAKEOTOMİ

Oral Surgery, Adenoidectomy, Tonsillectomy,
Laryngology, Bronchoscopy, Oesophagoscopy,
Tracheotomy

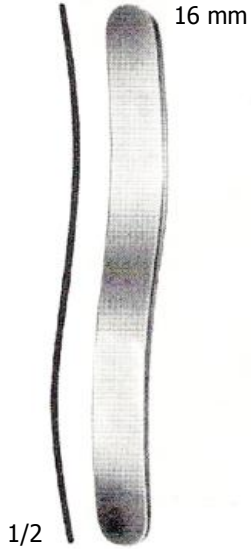

14.5 cm
ÜK.1926

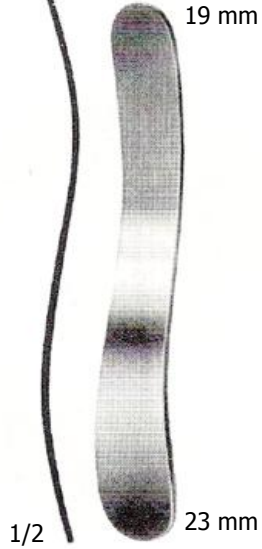

14.5 cm
ÜK.1927

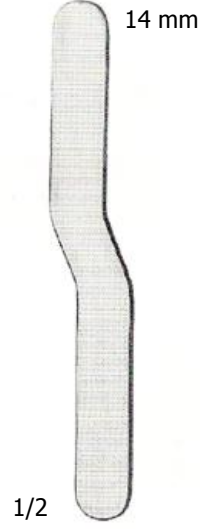

14.5 cm
ÜK.1928

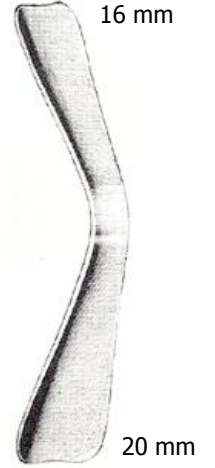

DOYEN
13 cm ÜK.1929
16 cm ÜK.1930

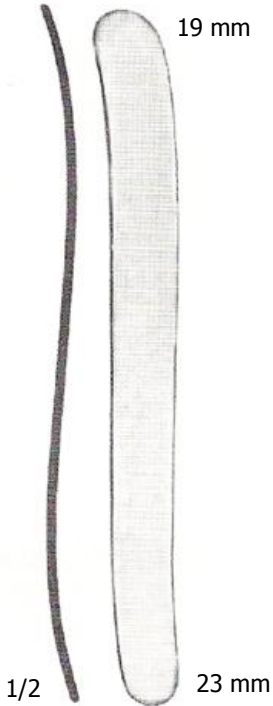

BUCHWALD – 18 cm
ÜK.1931



MAYO – 17 cm
ÜK.1932



KROENIG – 15 cm
ÜK.1933



1/2

WIEDER
ÜK.1934 – ÜK.1935



14 cm
ÜK.1934



1/1

15 cm
ÜK.1935



1/2

TOBOLD – 16 cm
ÜK.1936

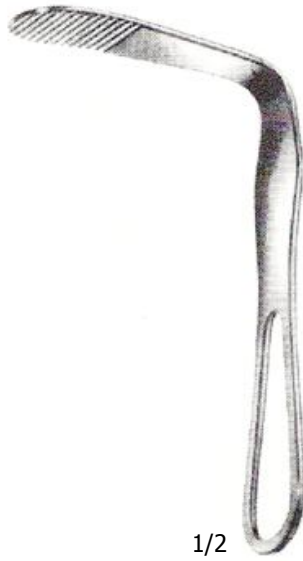

1/2

HARTMANN – 15 cm
ÜK.1937

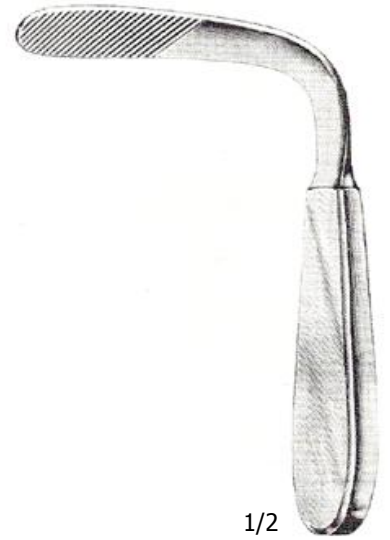

1/2

TOBOLD – 14.5 cm
ÜK.1938



McIVOR
Sayfa 180, 181'deki bütün çerçevelere uygun
Suitable for all frames on page 180, 181
ÜK.1939 – ÜK.1941

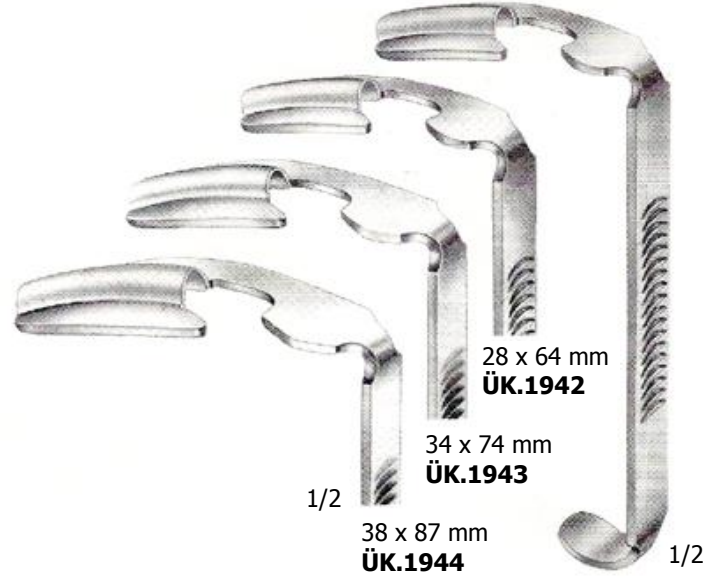

GAST
Sayfa 180, 181'deki bütün çerçevelere uygun
Suitable for all frames on page 180, 181
ÜK.1942 – ÜK.1944



DAVIS-BOYLE
Sayfa 180, 181'deki bütün çerçevelere uygun
Suitable for all frames on page 180, 181
ÜK.1945 – ÜK.1949

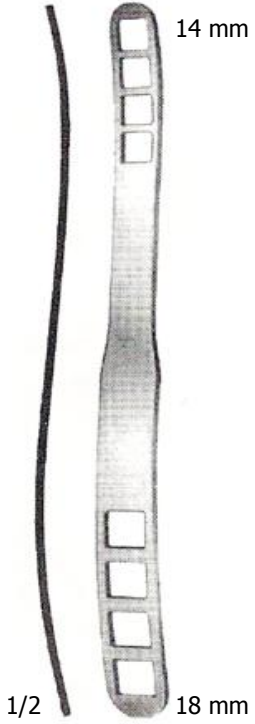

BRÜNINGS – 19 cm
ÜK.1950

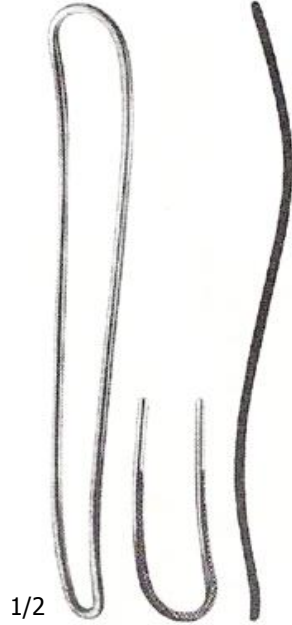

FRENZEL – 16.5 cm
ÜK.1951



MARTIN – 16.5 cm
ÜK.1952

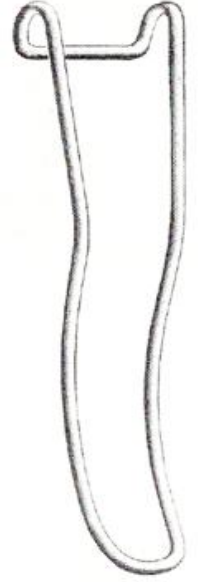

STEMBERG
14 cm ÜK.1953
16 cm ÜK.1954
18 cm ÜK.1955

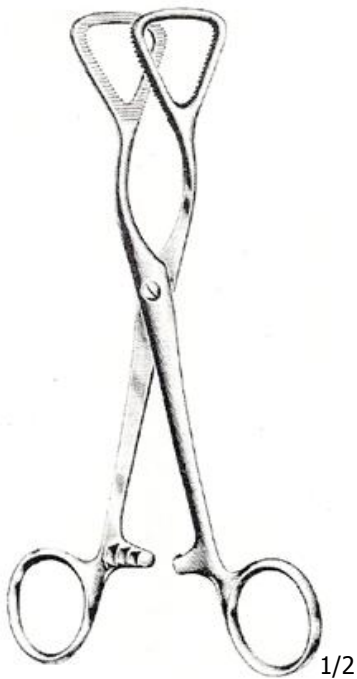

GUY – 19 cm
ÜK.1956

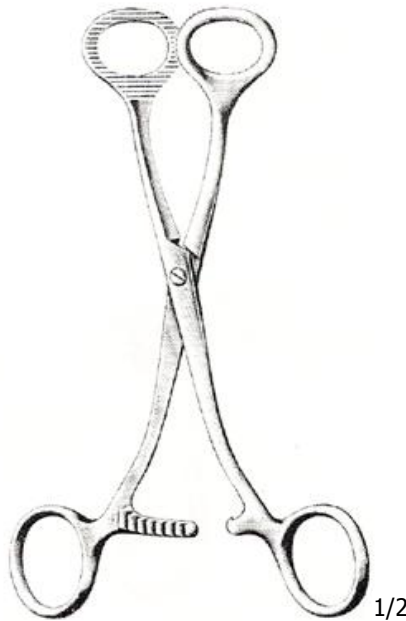

COLLIN – 17 cm
ÜK.1957



YOUNG – 17 cm
ÜK.1959



Çift/Pair
ÜK.1958

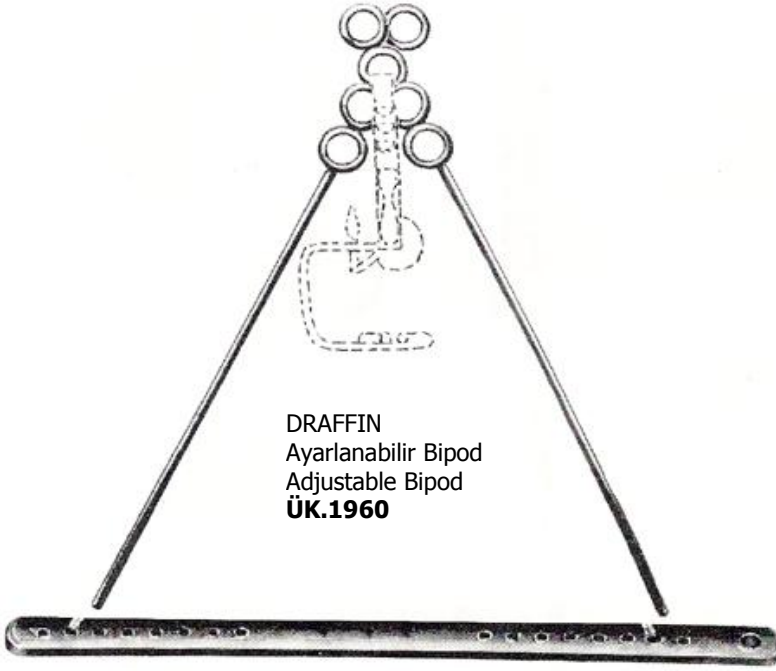

DRAFFIN
Ayarlanabilir Bipod
Adjustable Bipod
ÜK.1960

MAGAURAN
Bipod Paleti / Palet For Holding Bipod
ÜK.1961

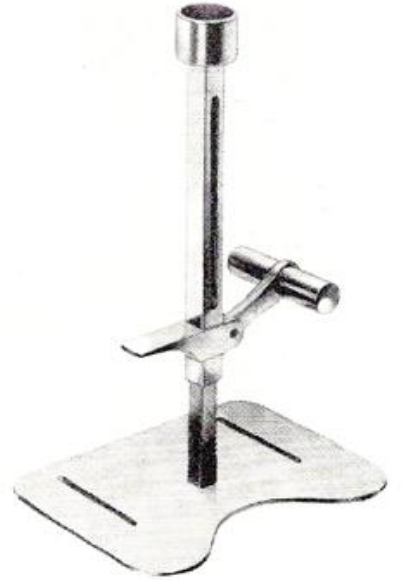

NEGUS
Göğüs Desteği
Chest Support
ÜK.1962



RUSSEL-DAVIS
Sayfa 180, 181'deki bütün çerçevelere uygun
Suitable for all frames on page 180, 181
ÜK.1963 – ÜK.1965



29 x 70 mm **ÜK.1966**
30 x 75 mm **ÜK.1967**
31 x 80 mm **ÜK.1968**
32 x 85 mm **ÜK.1969**
33 x 95 mm **ÜK.1970**
33 x 100 mm **ÜK.1971**
34 x 105 mm **ÜK.1972**

Sayfa 180, 181'deki bütün çerçevelere uygun
Suitable for all frames on page 180, 181

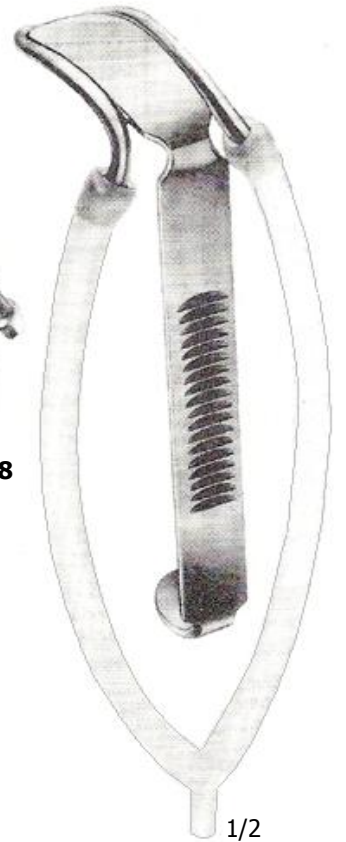

DAVIS-MEYER
ÜK.1966 – ÜK.1972

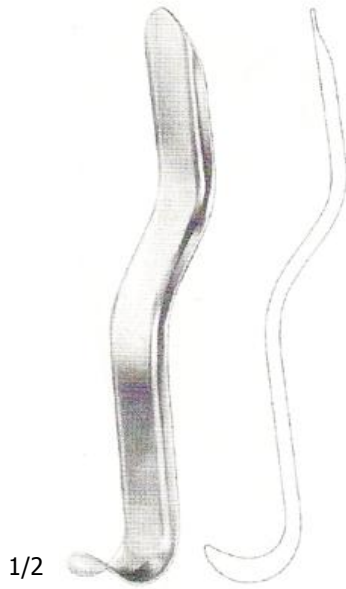

1/2

CAWOOD – 15.5 cm
ÜK.1973



1/2

BISHOP – 13 cm
ÜK.1974



1/2

MARTIN-SIMPLEX – 15.5 cm
ÜK.1975



MIDDELDORPF
ÜK.1976 – ÜK.1978



23.5 cm
28 x 28 mm
ÜK.1976



23.5 cm
28 x 28 mm
ÜK.1977



23.5 cm
28 x 28 mm
ÜK.1978

1/1



1/2

MORITZ-SCHMIDT – 19 cm
ÜK.1979

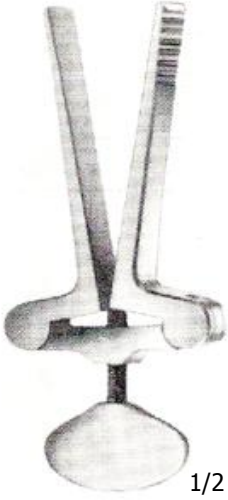

1/2

HEISTER – 13 cm
ÜK.1980

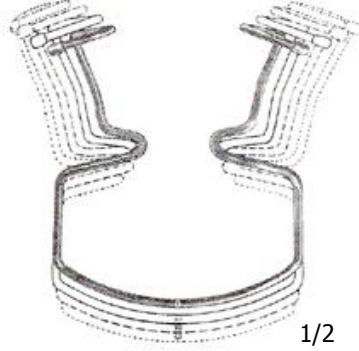

1/2

ORINGER
3'lü Set/3' Set ÜK.1981
(ÜK.1982 – ÜK.1983 – ÜK.1984)
Şekil 1 / Fig.1 ÜK.1982
Şekil 2 / Fig.2 ÜK.1983
Şekil 3 / Fig.3 ÜK.1984



SCHMID
ÜK.2363

Şekil 0/ Fig.0 ÜK.1985
Çocuklar İçin/For Children

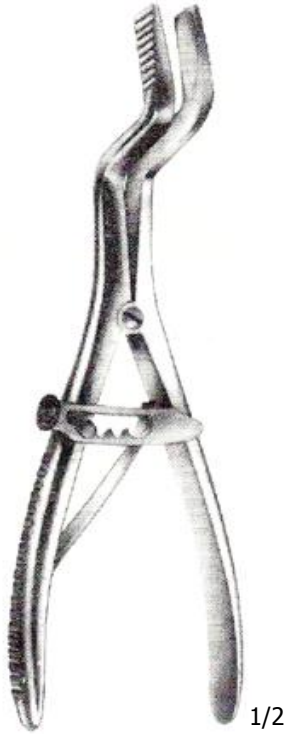

1/2

ROSER-KÖNIG – 18.5 cm
ÜK.1986

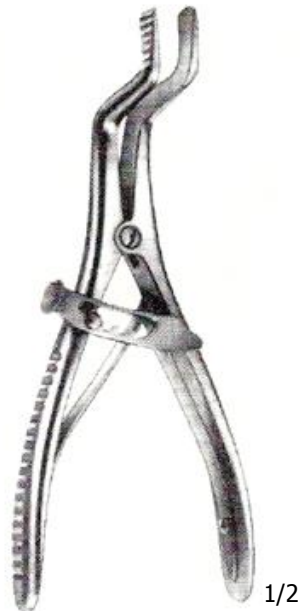

1/2

ROSER-KÖNIG – 16 cm
ÜK.1987



1/2

FERGUSSON-ACKLAND
16 cm ÜK.1988

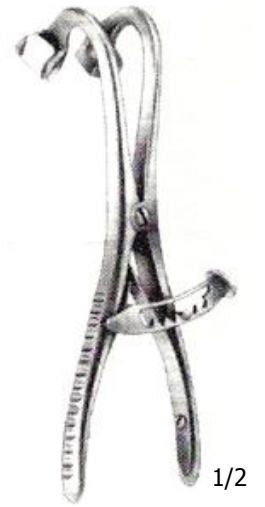

1/2

DENHARDT – 12.5 cm
Değiştirilebilir Silikon Parçalı
Silicon Insert Interchangeable
ÜK.1989



WHITEHEAD
9 cm ÜK.1990
11 cm ÜK.1991
13 cm ÜK.1992
15 cm ÜK.1993



WHITEHEAD-JENNINGS
9 cm ÜK.1994
11 cm ÜK.1995
13 cm ÜK.1996
15 cm ÜK.1997



DOYEN-JANSEN – 14 cm
ÜK.1998



DOYEN-COLLIN – 12 cm
ÜK.1999



MOLT – 10 cm
ÜK.2000

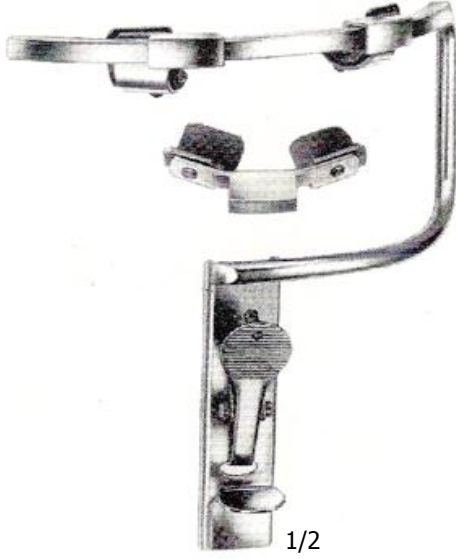

DAVIS-MEYER
ÜK.2001
Sayfa 174, 176, 181'deki bütün dil
basacaklarına uygun
Suitable for all tongue depressors as
shown on pages 174, 176, 181



ÜK.2002
ÜK.2001 İçin Damak Bleydi
Palate Blade To Use With ÜK.2001
Dişsiz hastalarda kullanılır
For toothless patients



DAVIS-BOYLE
Büyükler İçin/For Adults **ÜK.2003**
Sayfa 174, 176, 181'deki bütün dil
basacaklarına uygun
Suitable for all tongue depressors as
shown on pages 174, 176, 181



McIVOR
ÜK.2004
Sayfa 174, 176, 181'deki bütün dil
basacaklarına uygun
Suitable for all tongue depressors as
shown on pages 174, 176, 181

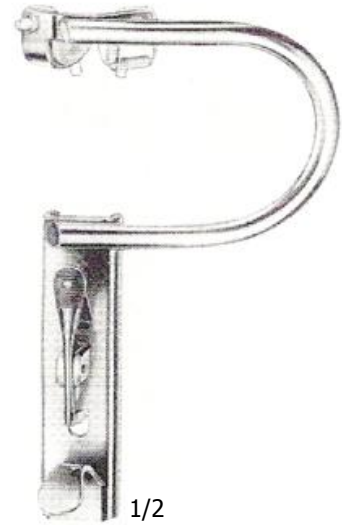

DAVIS-BOYLE
Çocuklar İçin/For Children **ÜK.2005**
Gençler İçin/For Adolescents **ÜK.2006**
Sayfa 174, 176, 181'deki bütün dil
basacaklarına uygun
Suitable for all tongue depressors as
shown on pages 174, 176, 181



1/2

KILNER-DOUGHTY
ÜK.2007

Sayfa 174, 176, 181'deki bütün dil basacaklarına uygun
Suitable for all tongue depressors as shown on pages 174, 176, 181



29 x 67 mm
ÜK.2008

33 x 75 mm
ÜK.2009

38 x 85 mm
ÜK.2010

40 x 92 mm
ÜK.2011

46 x 100 mm
ÜK.2012

1/2

KILNER-DOUGHTY
ÜK.2008 – ÜK.2012
Sayfa 180, 181'deki bütün çerçevelere uygun
Suitable for all frames on pages 180, 181

Yalnız Çerçeve/Frame Only
ÜK.2013

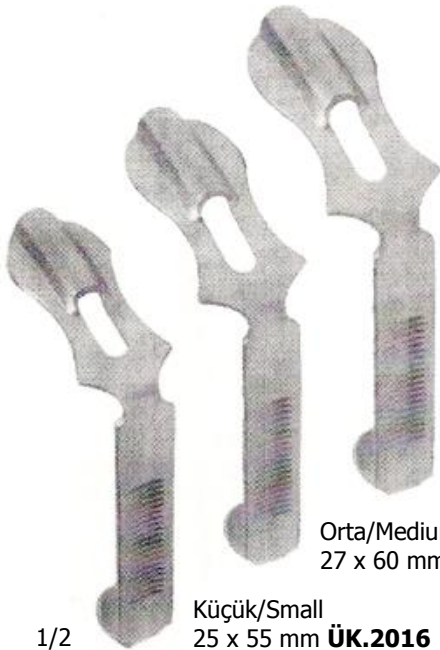

Büyük/Large
30 x 70 mm ÜK.2014

Orta/Medium
27 x 60 mm ÜK.2015

Küçük/Small
25 x 55 mm ÜK.2016

1/2

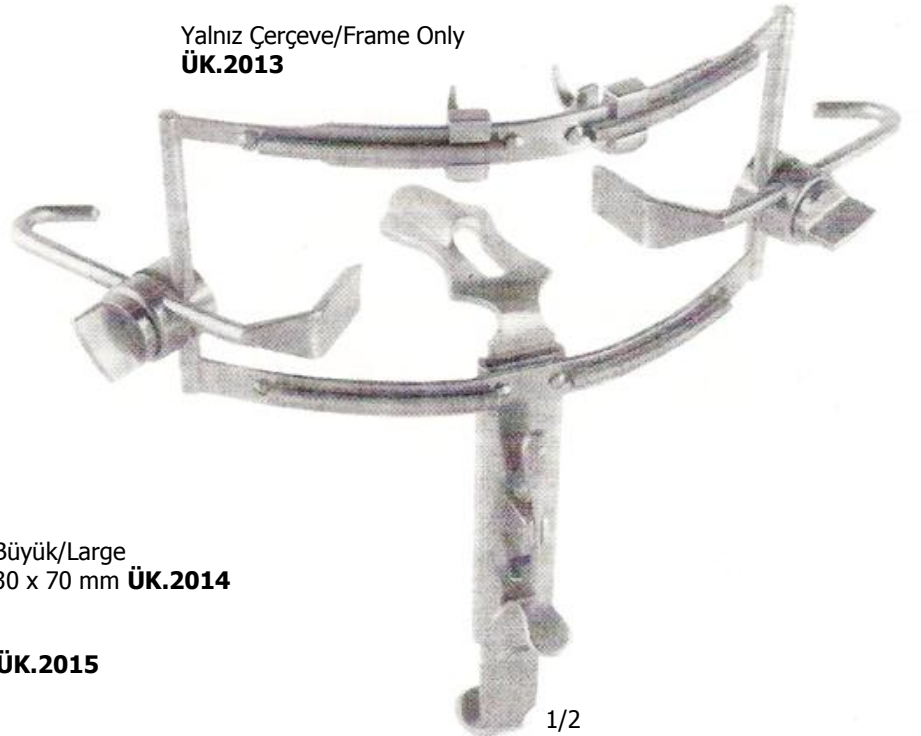

1/2

DINGMAN
Komple/Complete ÜK.2017
(ÜK.2013 – ÜK.2014 – ÜK.2015 – ÜK.2016)

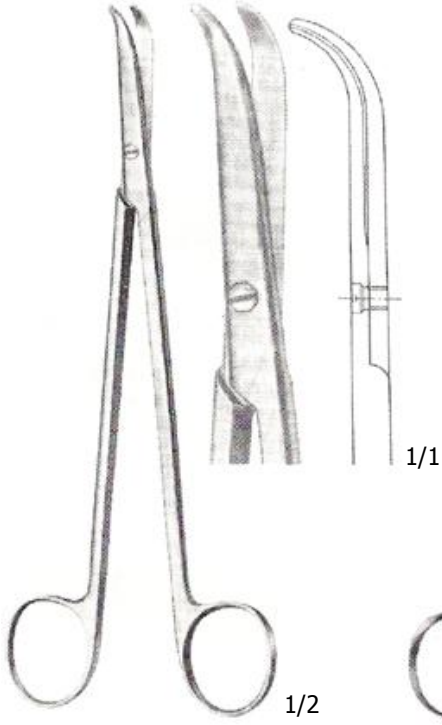

THOREK – 18 cm
ÜK.2018

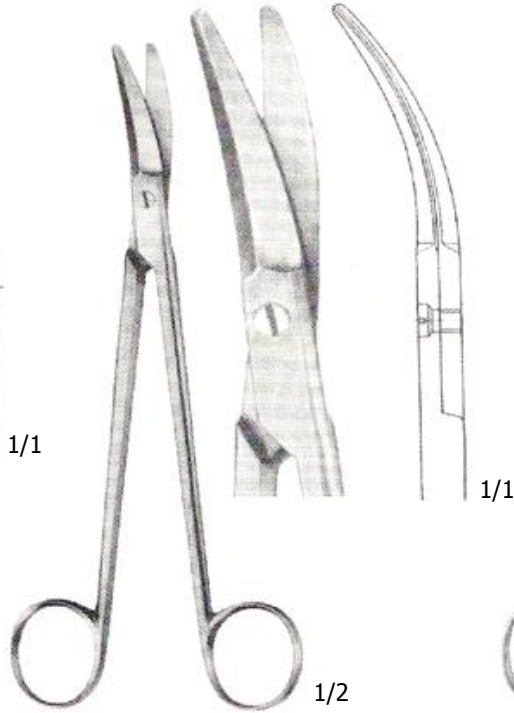

BOETTCHER – 18 cm
ÜK.2019

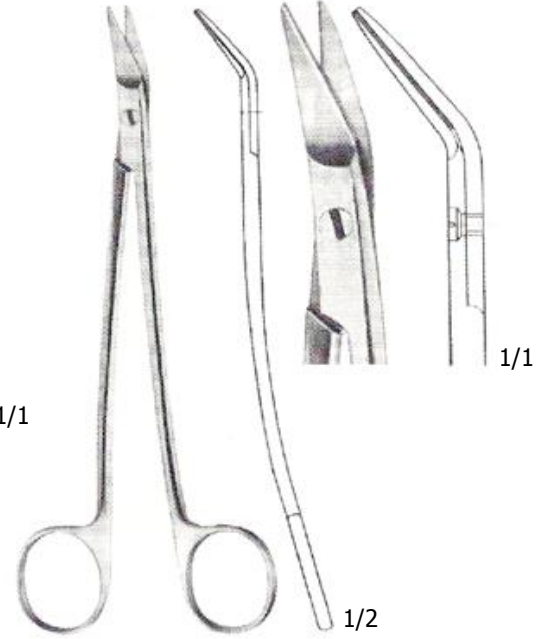

DEAN – 17 cm
Çift Ağız Tırtıllı/Both Jaws Serrated
ÜK.2020

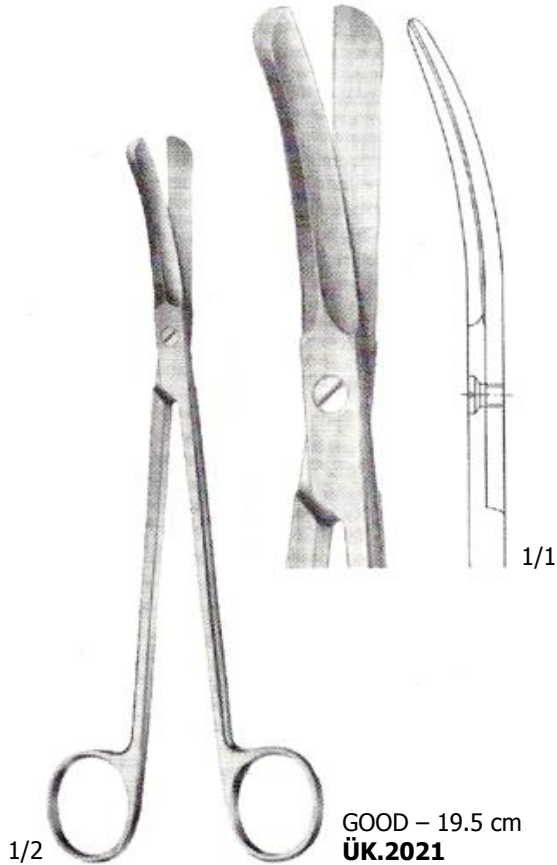

GOOD – 19.5 cm
ÜK.2021

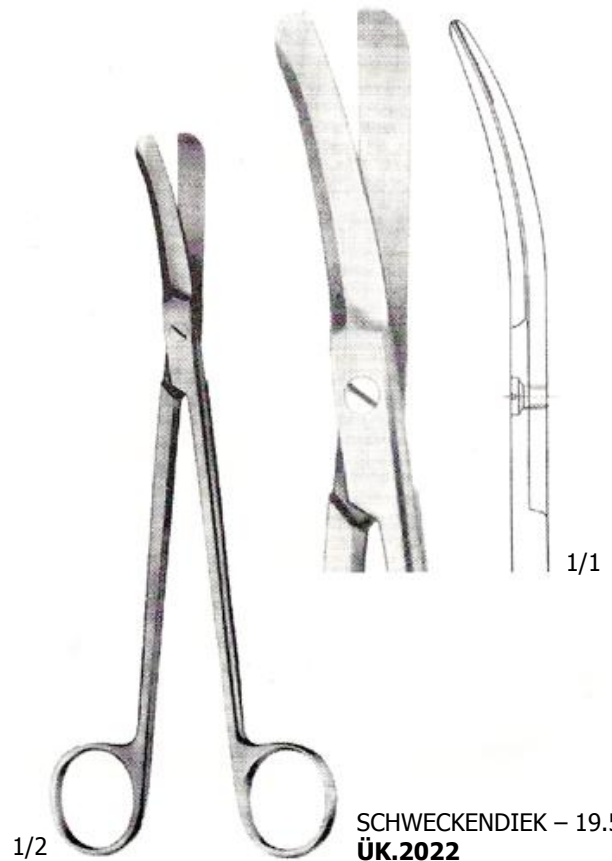

SCHWECKENDIEK – 19.5 cm
ÜK.2022



1/2

EVES – 25 cm
ÜK.2023



1/2

EVES – 25 cm
ÜK.2024



1/2

BRÜNINGS – 25 cm
ÜK.2025

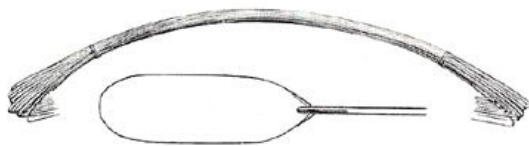

12'lik Paket/Package Of 12 pcs
Ø 0.3 mm ÜK.2026
Ø 0.5 mm ÜK.2027



10 m'lik Tel Bobin
Wire Coils Of 10 meters
Ø 0.3 mm ÜK.2028

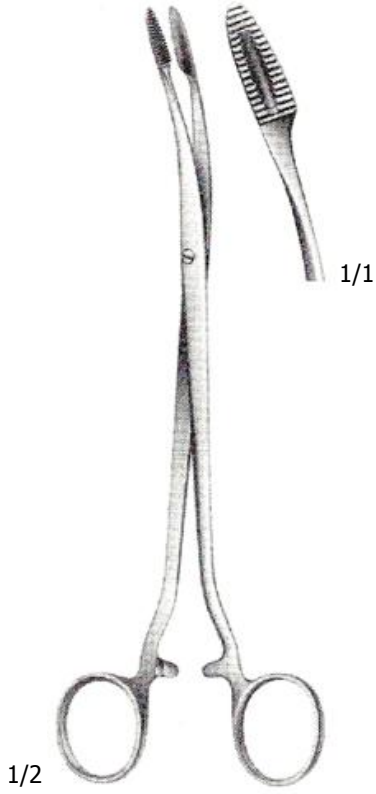

DUPLAY – 21 cm
ÜK.2029

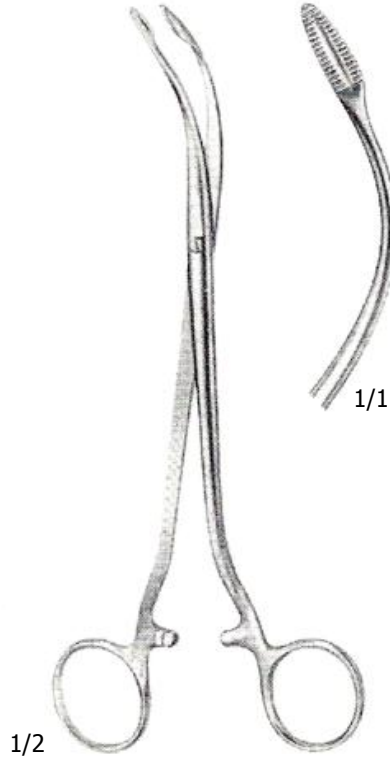

DUPLAY – 19 cm
ÜK.2030

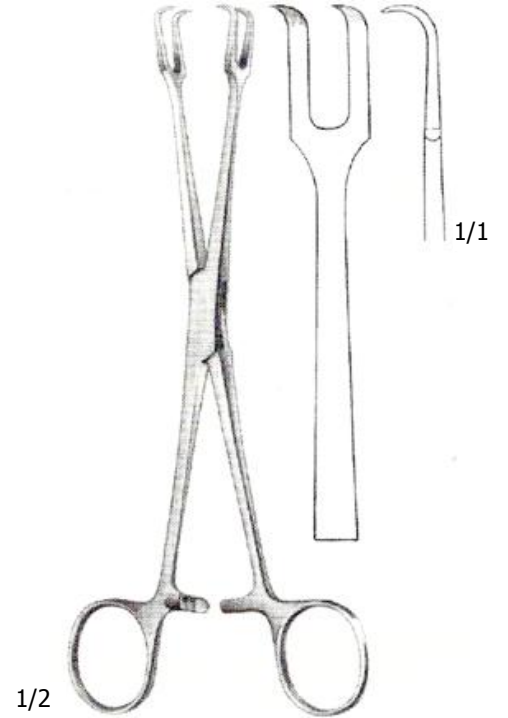

MUSEUX – 20 cm
ÜK.2031

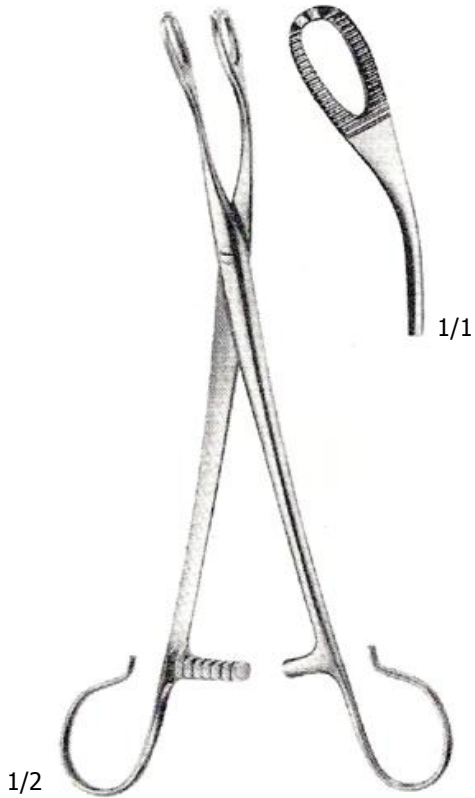

BLOHMKE – 20.5 cm
ÜK.2032



ABRAHAM – 20.5 cm
ÜK.2033

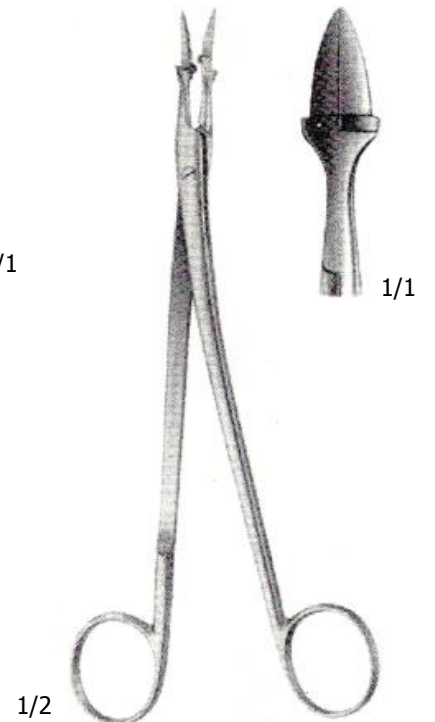

THILENIUS – 19 cm
ÜK.2034

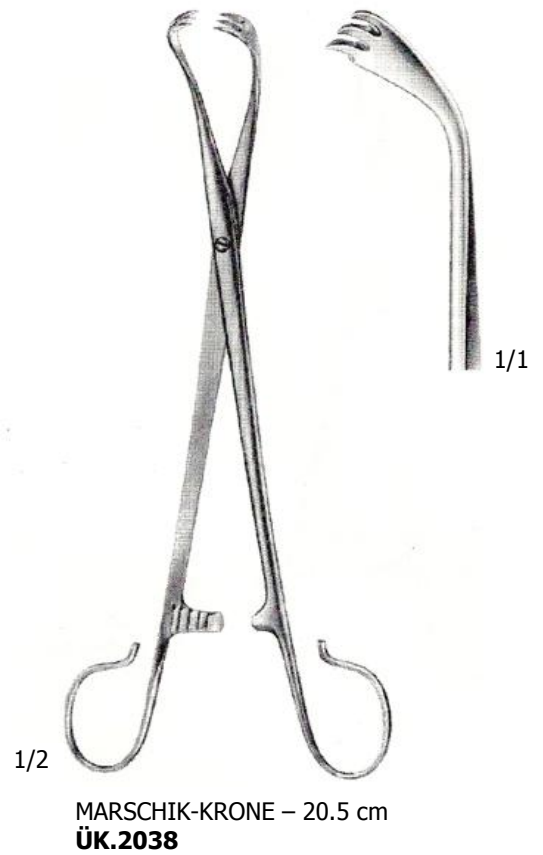
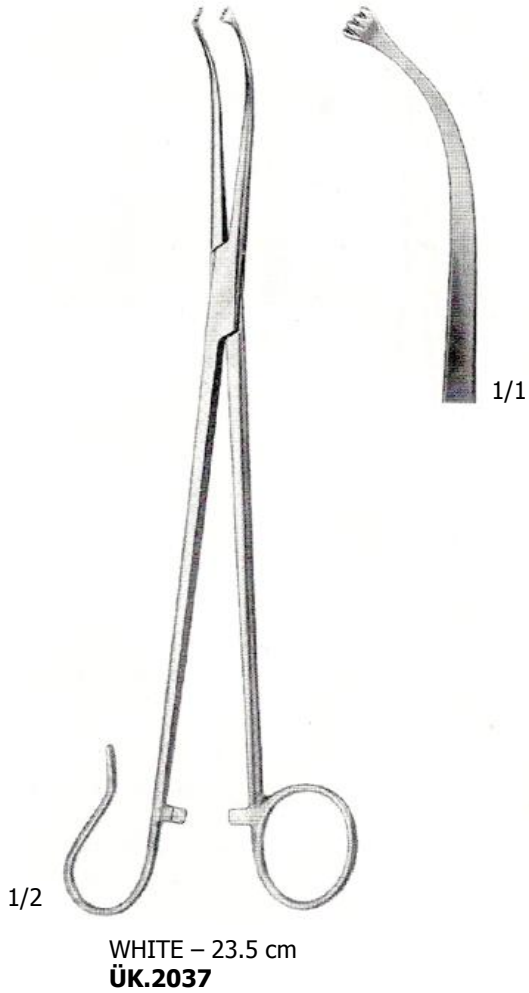
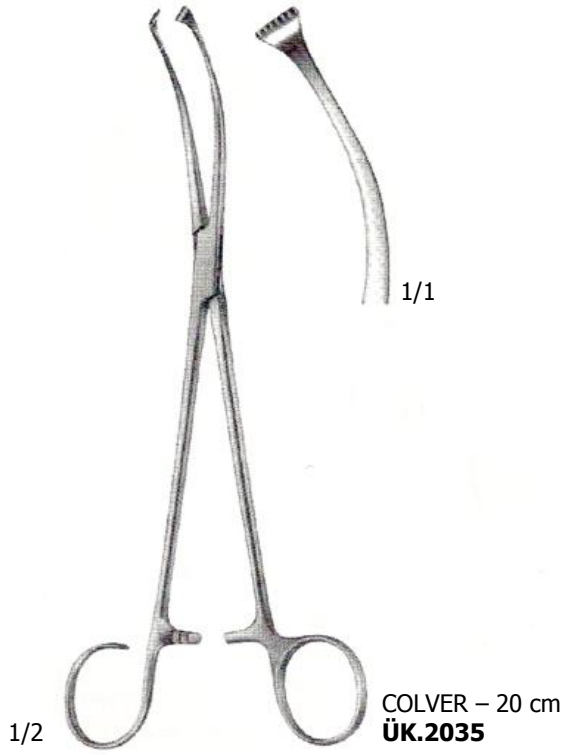

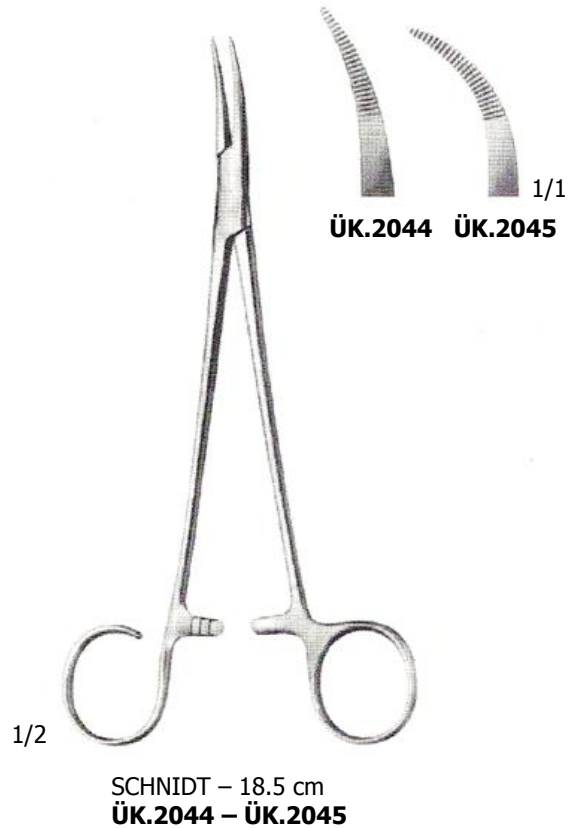
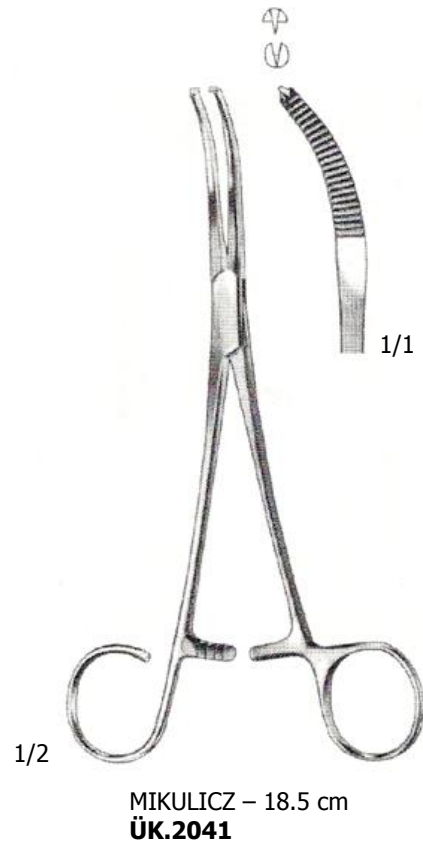

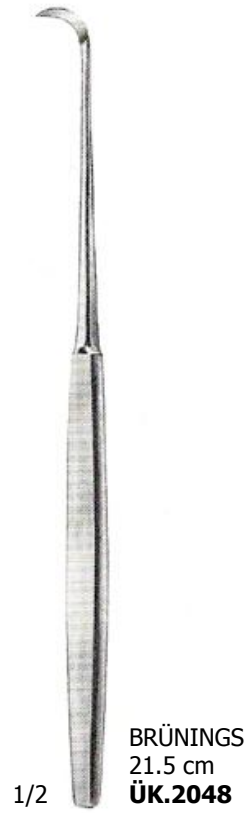

12 mm

17 mm

6 mm

10 mm

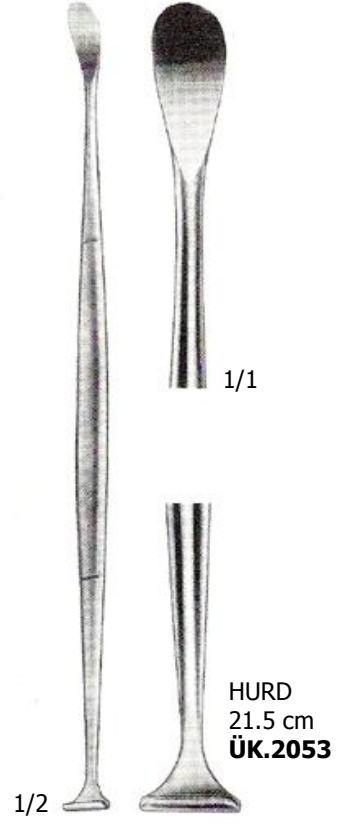
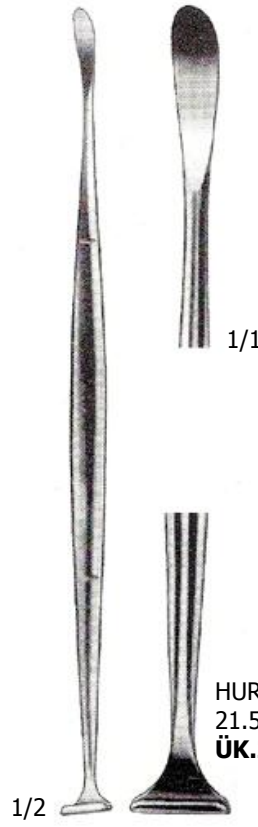
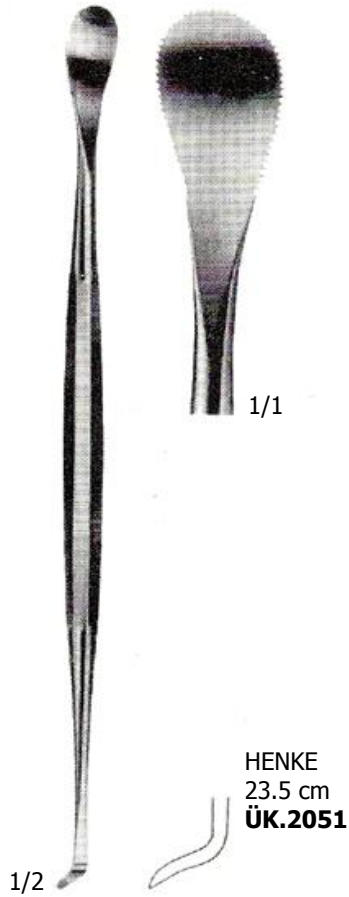
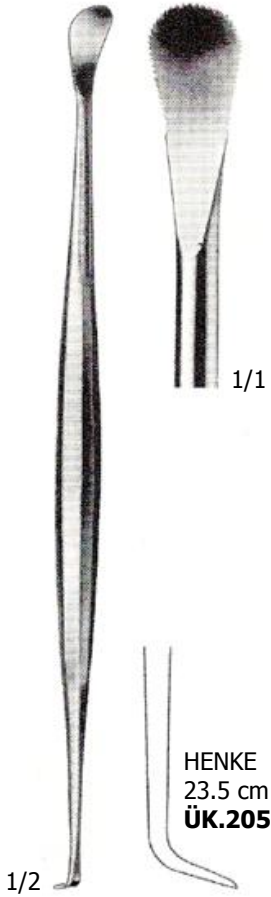

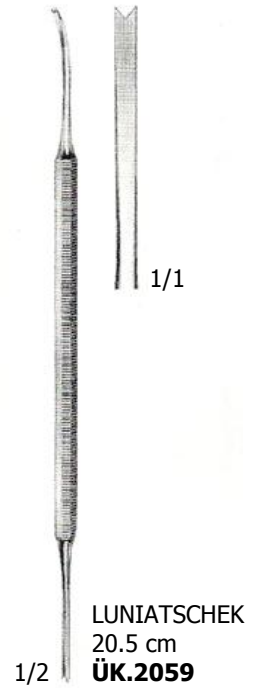
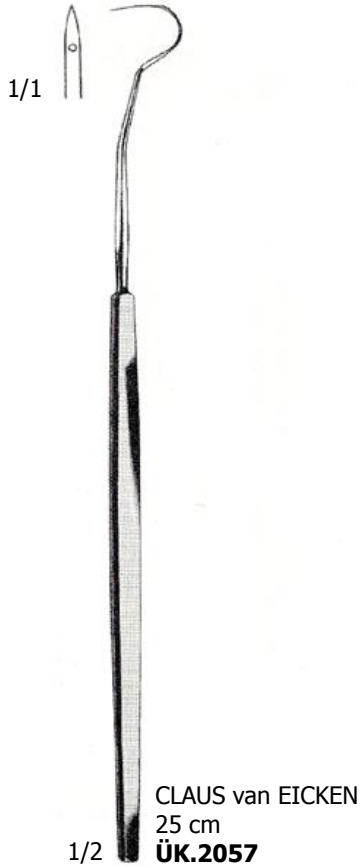
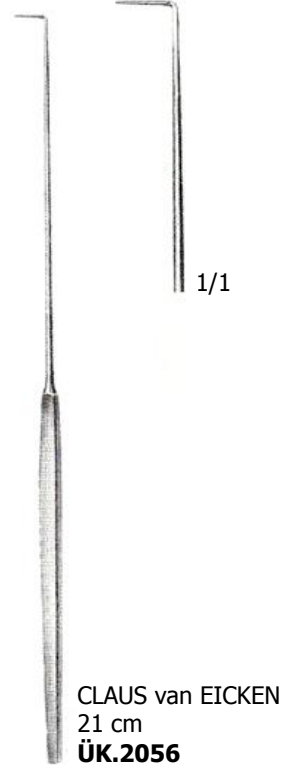
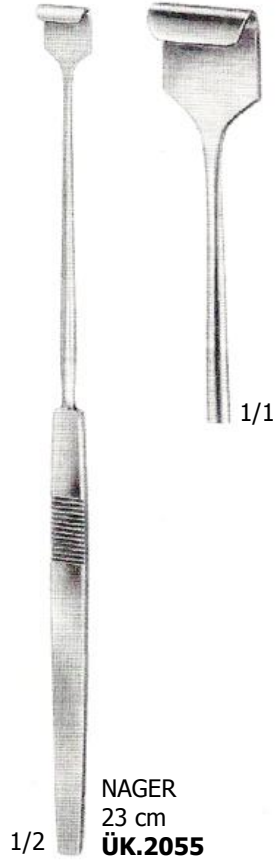
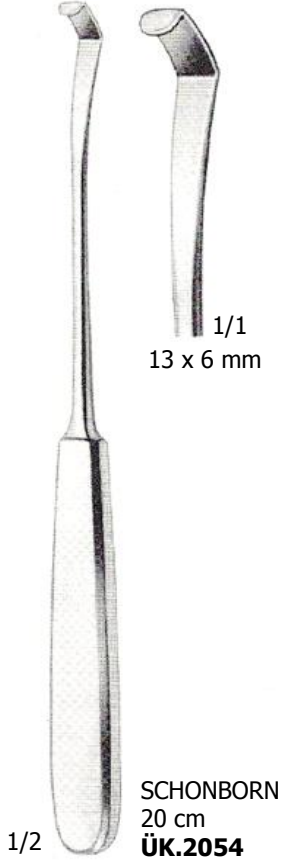



BECKMANN – 20 cm
ÜK.2060 – ÜK.2063

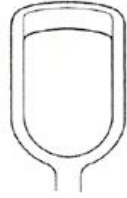

ÜK.2060

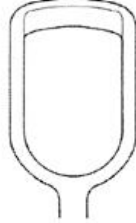

ÜK.2061

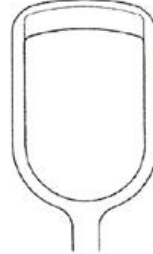

ÜK.2062

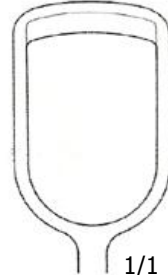

ÜK.2063 1/1



BECKMANN – 20 cm
ÜK.2064 – ÜK.2069

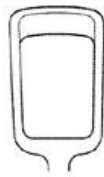

ÜK.2064



ÜK.2065



ÜK.2066



ÜK.2067

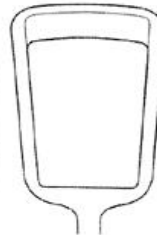

ÜK.2068

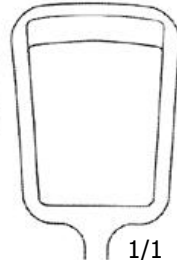

ÜK.2069 1/1

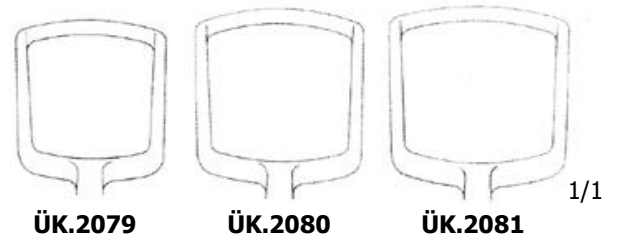
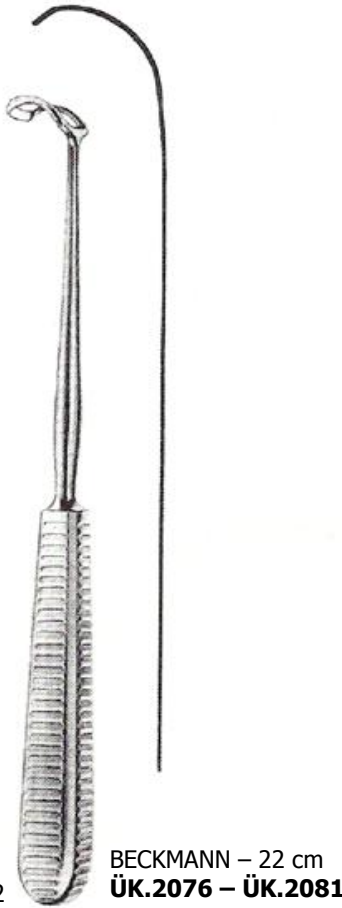
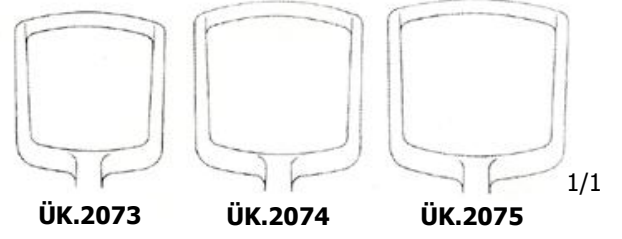



1/2

LA FORCE – 23 cm

ÜK.2082

ÜK.2083

ÜK.2084



ÜK.2082

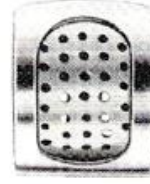

ÜK.2083

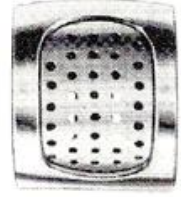

ÜK.2084

1/1

Yalnız Yedek Bleydler
Spare Blades Only



1/2

ST. CLAIR-THOMPSON
ÜK.2088 – ÜK.2093



21 cm
8.5 mm **ÜK.2088**



21 cm
10 mm **ÜK.2089**



21 cm
13 mm **ÜK.2090**

1/1

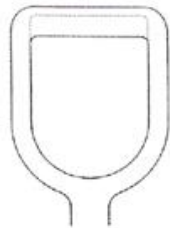

21.5 cm
15 mm **ÜK.2091**



21.5 cm
16.5 mm **ÜK.2092**



21.5 cm
18 mm **ÜK.2093**

1/1

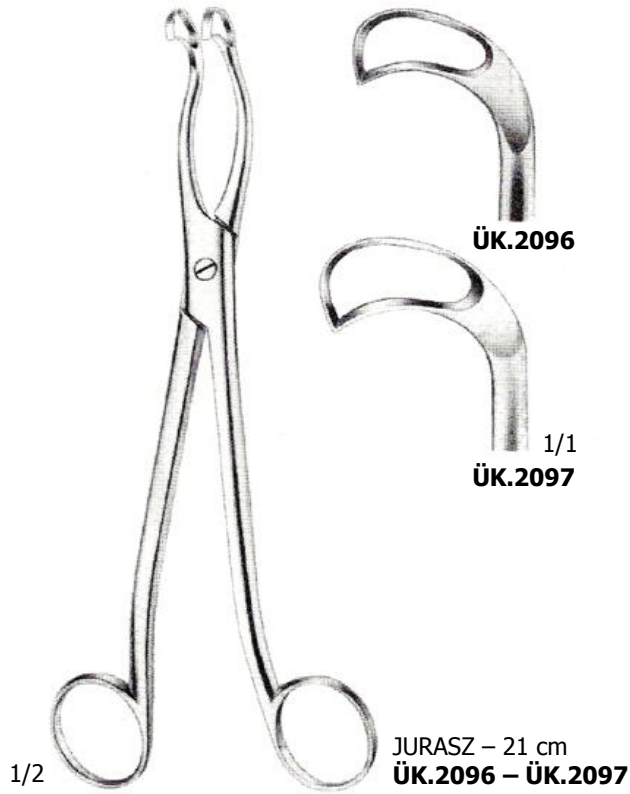
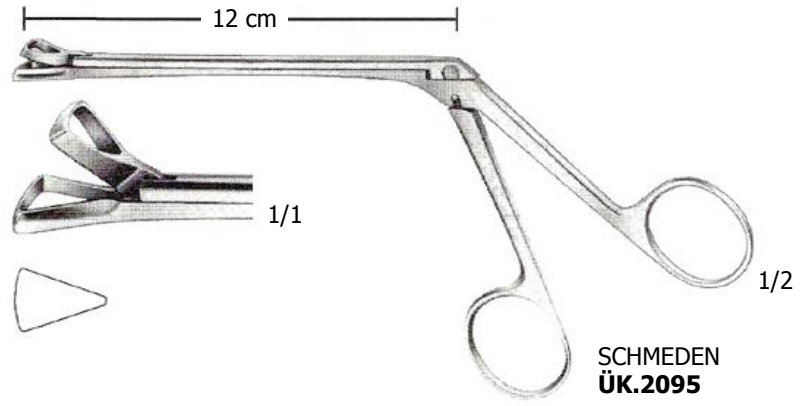
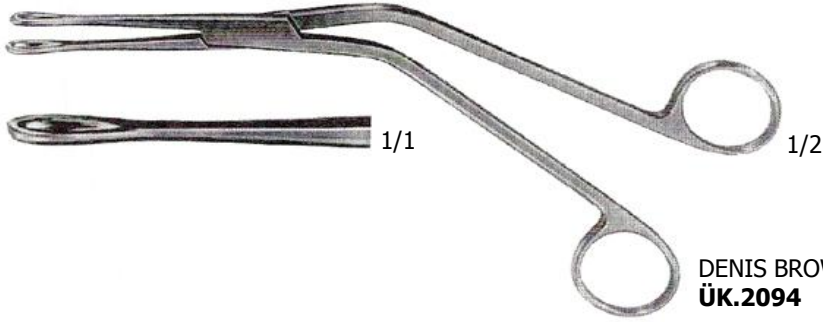

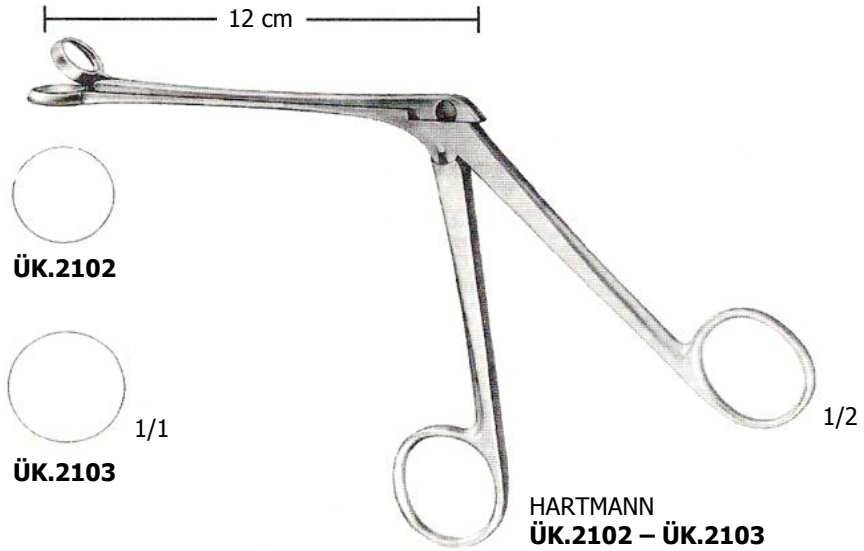
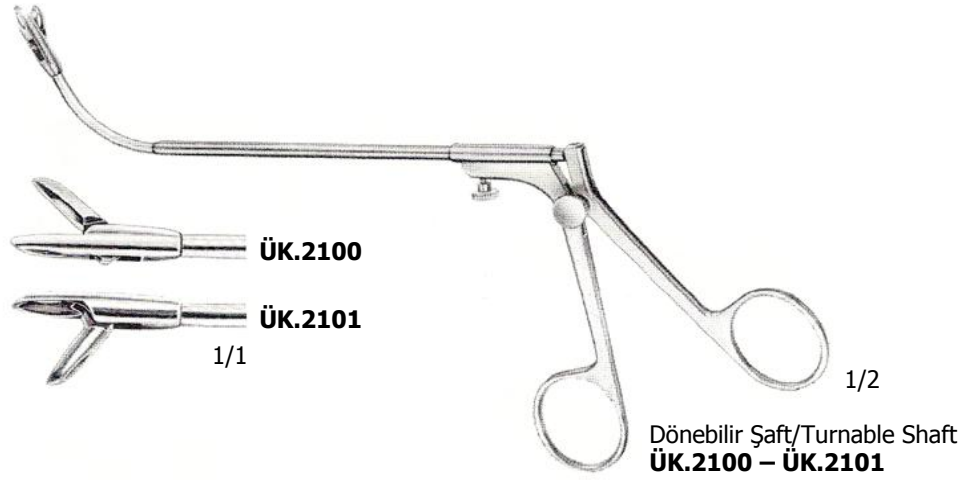
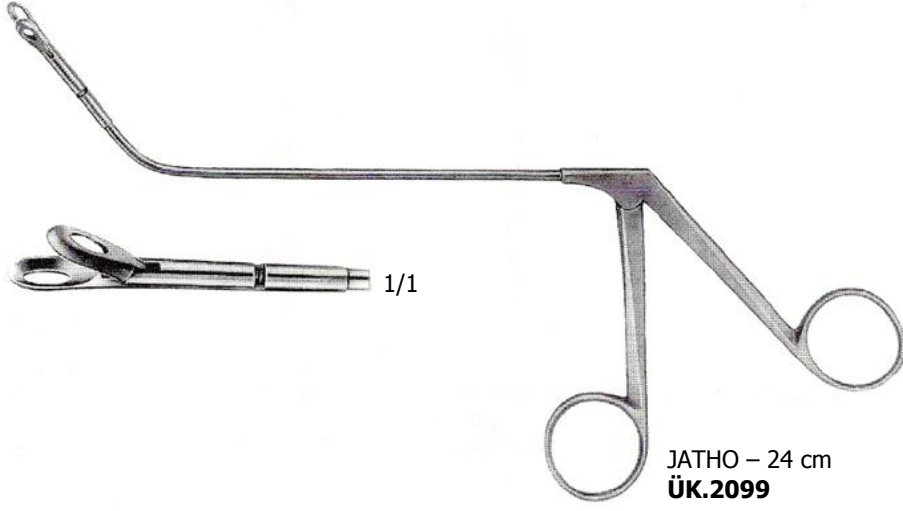



Fig.000
Ø 6 mm
ÜK.2104
ÜK.2117



Fig.00
Ø 8 mm
ÜK.2105
ÜK.2118



Fig.0
Ø 10 mm
ÜK.2106
ÜK.2119



Fig.1
Ø 12 mm
ÜK.2107
ÜK.2120



Fig.2
Ø 14 mm
ÜK.2108
ÜK.2121



Fig.3
Ø 16 mm
ÜK.2109
ÜK.2122



Fig.4
Ø 18 mm
ÜK.2110
ÜK.2123



Fig.5
Ø 20 mm
ÜK.2111
ÜK.2124



Fig.6
Ø 22 mm
ÜK.2112
ÜK.2125



Fig.7
Ø 24 mm
ÜK.2113
ÜK.2126



Fig.8
Ø 26 mm
ÜK.2114
ÜK.2127



Fig.9
Ø 28 mm
ÜK.2115
ÜK.2128



Fig.10
Ø 30 mm
ÜK.2116
ÜK.2129



Ø 12 mm
ÜK.2132



Ø 14 mm
ÜK.2133

ÜK.2134 ÜK.2135
Yedek Aynalar
Spare Mirrors, Only



1/2

18 cm
Altigen Saplı Laryngeal
Aynalar
Laryngeal Mirrors With
Hexagonal Handle
ÜK.2104 – ÜK.2116



1/2

12 cm
Laryngeal Aynalar
Laryngeal Mirrors
ÜK.2117 – ÜK.2129



1/2

11 cm
Ayna Sapı
Mirror Handle
ÜK.2130



1/2

10.5 cm
Ayna Sapı
Mirror Handle
ÜK.2131



1/2

MICHEL – 25 cm
Rinoskopik Aynalar
(Değiştirilebilir Aynalar)
Rhinoscopic Mirrors,
With Interchangeable Mirror Insert
ÜK.2132 – ÜK.2133

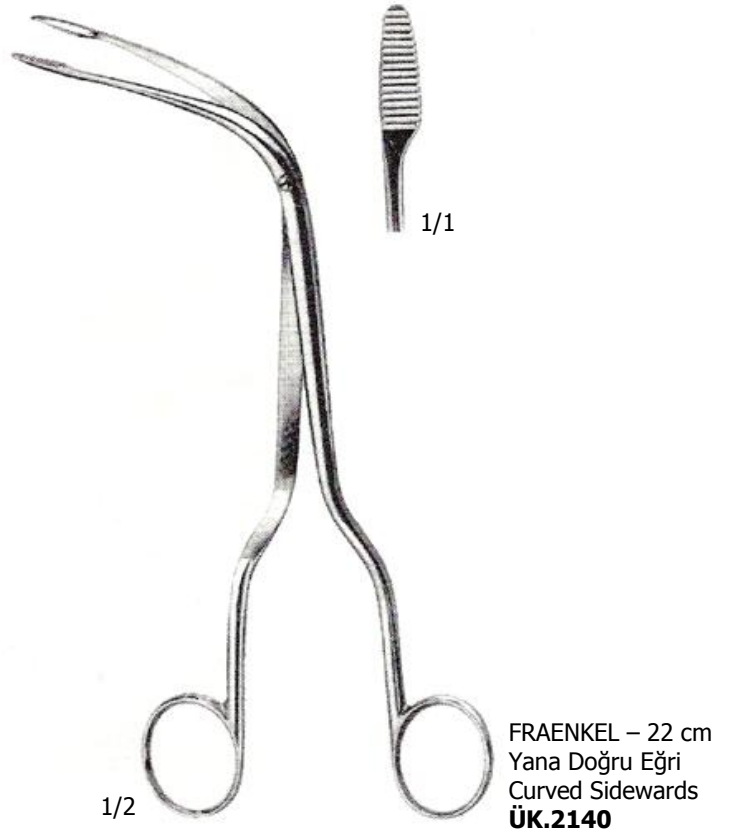
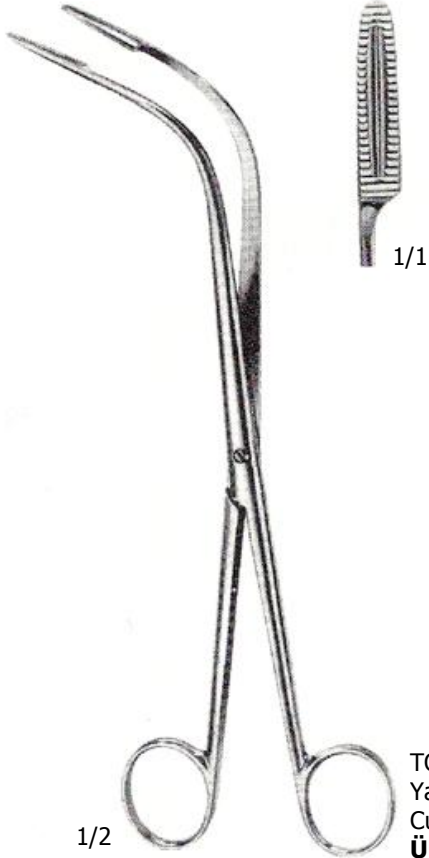
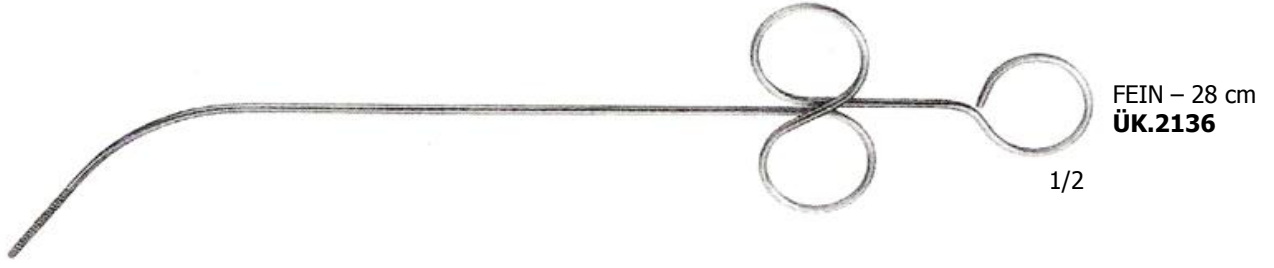

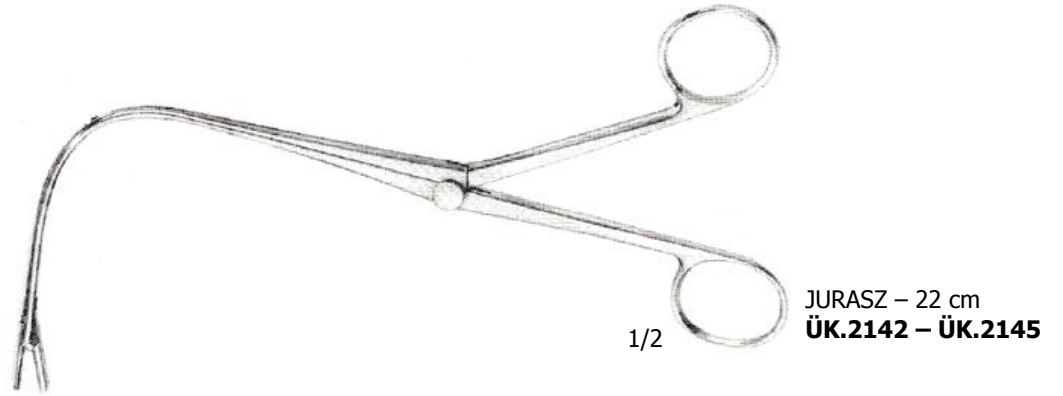
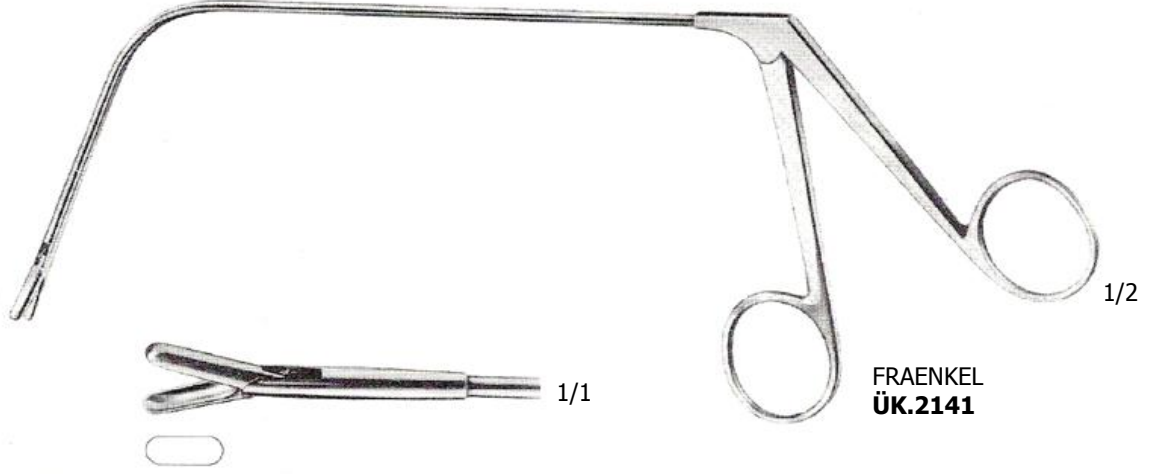

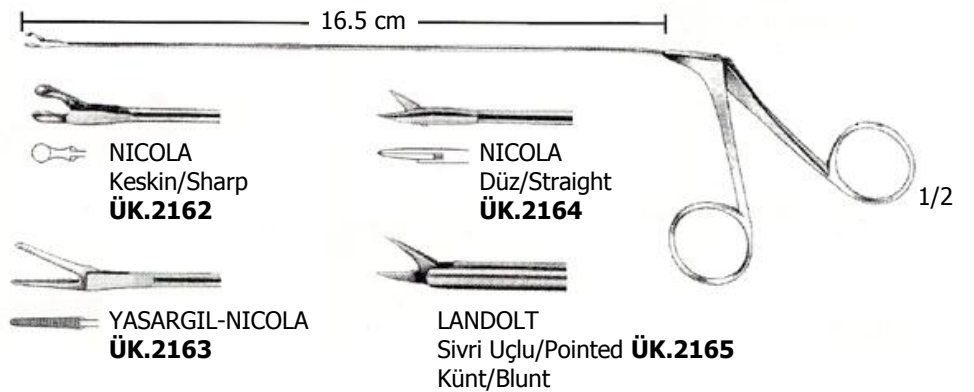
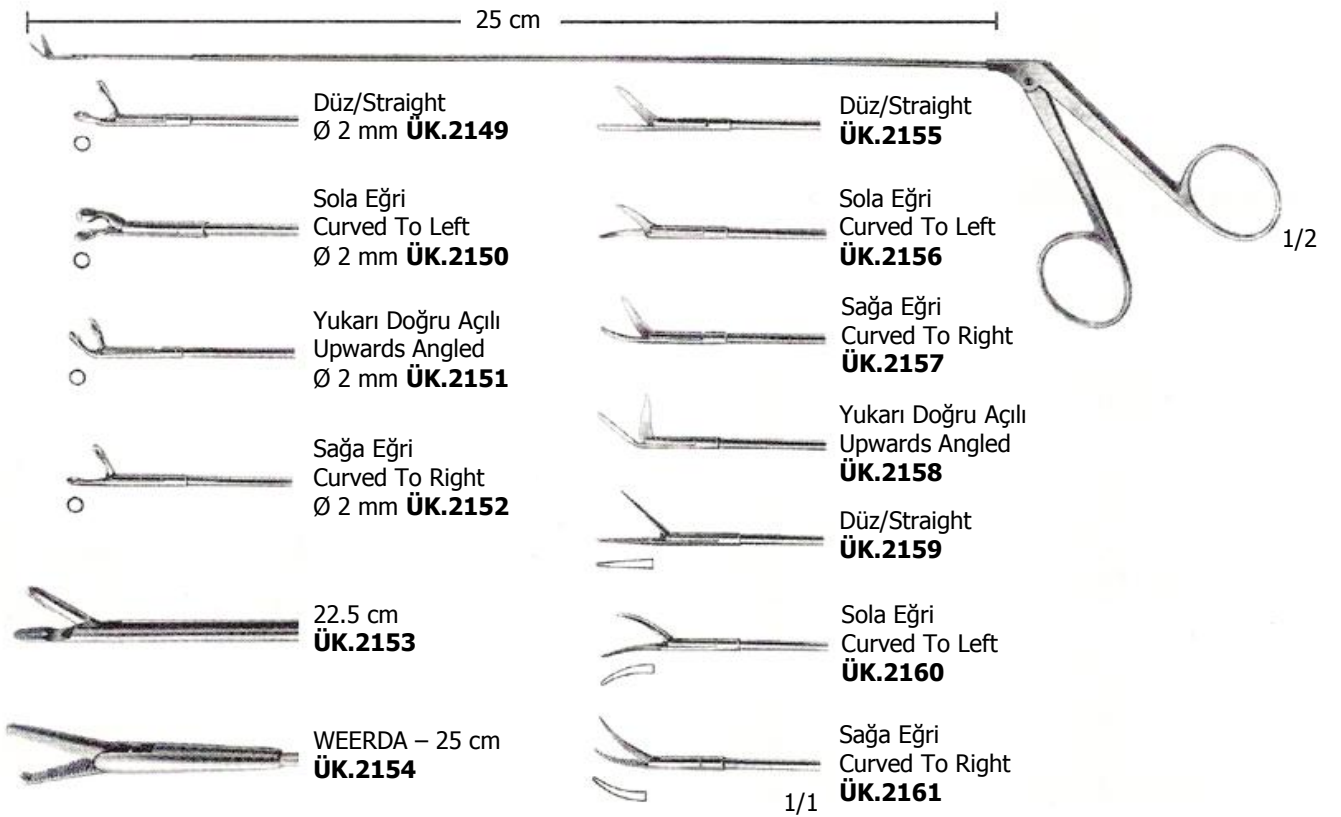
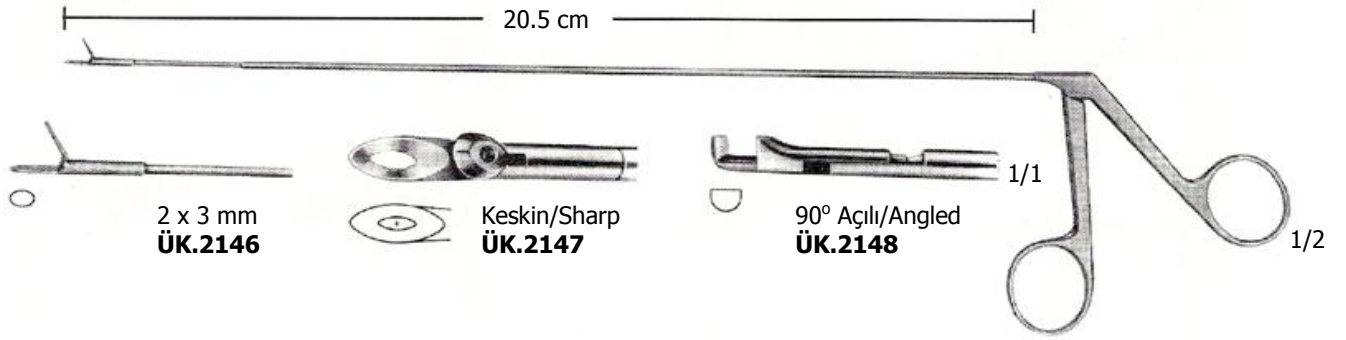

ÜK.2194 – ÜK.2195 üniversal sapları ve ÜK.2186 – ÜK.2193 tüpleri için
Tips for universal handles ÜK.2194 – ÜK.2195 and tubes ÜK.2186 – ÜK.2193

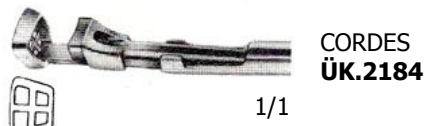
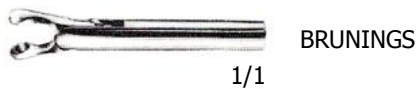
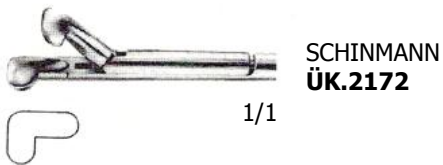
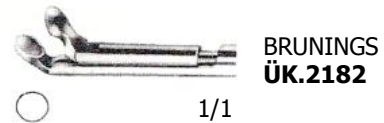
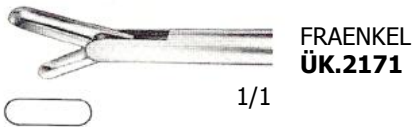
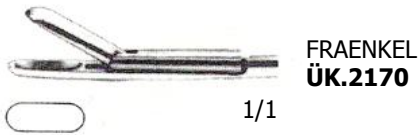
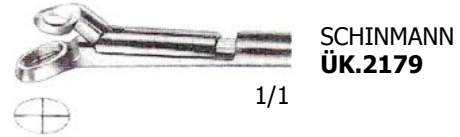
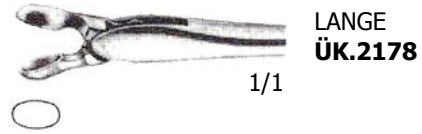
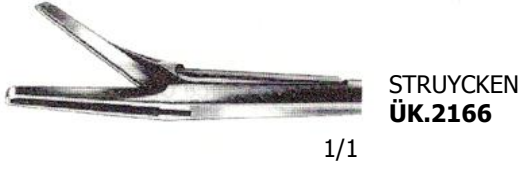



BRUNINGS - 20 cm
Uzatma Şaftı/Extension Cannulas
20 cm **ÜK.2186**
25 cm **ÜK.2187**
30 cm **ÜK.2188**
35 cm **ÜK.2189**
40 cm **ÜK.2190**
50 cm **ÜK.2191**



BRUNINGS - 20 cm
Bükülmez/Stiff **ÜK.2192**
Bükülebilir/Flexible **ÜK.2193**

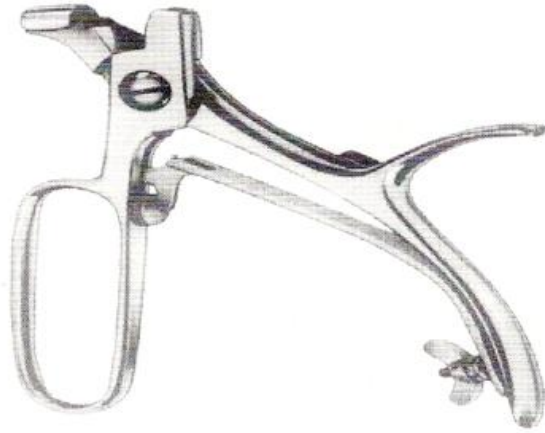

14 cm
Üniversal Sap
Universal Handle
ÜK.2194

1/2



HUBER – 14 cm
Üniversal Sap
Universal Handle
ÜK.2195

1/2

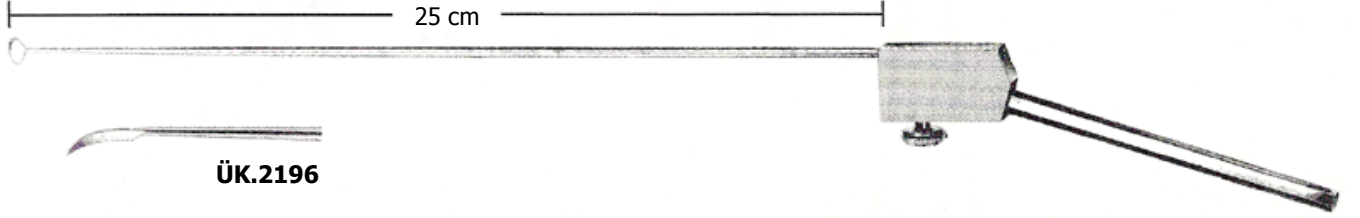

ÜK.2196



ÜK.2197



ÜK.2198



45° ÜK.2199
Ø 3.5 mm



90° ÜK.2200
Künt/Blunt



30° ÜK.2201
Geriye Doğru Eğri
Backwards Curved



ÜK.2202 1/1



ÜK.2203 1/2
ÜK.2196 – ÜK.2202 İçin Sap
Handle For Use With Instruments
ÜK.2196 – ÜK.2202



Kesici Teli Olarak ÜK.2026 Kullanılır
ÜK.2026 Uses As Snare Wires
ÜK.2204

Komple/Complete **ÜK.2205**
Yetişkinler ve Çocuklar İçin
For Adults and Children

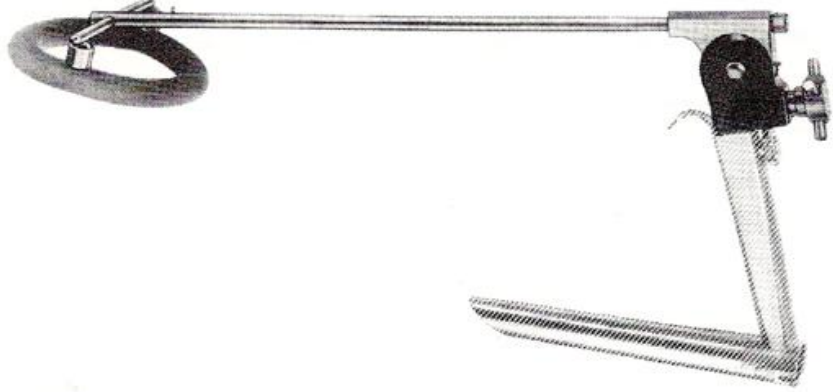

18 cm **ÜK.2206**
Yetişkinler İçin, Büyük Boy
For Adults, Large Size



18 cm **ÜK.2207**
Yetişkinler İçin, Orta Boy
For Adults, Medium Size



18 cm **ÜK.2208**
Gençler İçin, Küçük Boy
For Adults, Medium Size



13 cm **ÜK.2209**
Çocuklar İçin
For Children

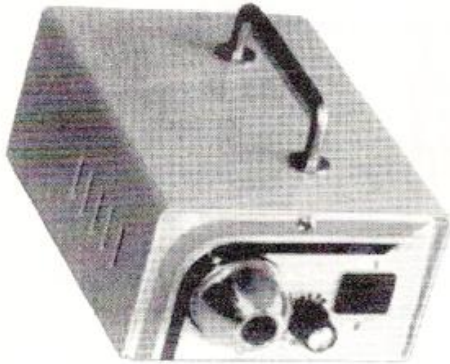

250 Watt, Soğuk Işık Kaynağı
250 Watts, Light Source
ÜK.2210



Ø 3.5 mm 180 cm **ÜK.2211**
Ø 4.8 mm 250 cm **ÜK.2212**
Fiber Optik Işık Taşıyıcı
Fiber Optic Light Transmitter



ÜK.2213
ÜK.2209 ile kullanılır
To Be Used With ÜK.2209



ÜK.2214
ÜK.2206, ÜK.2207, ÜK.2208 ile kullanılır
To Be Used With ÜK.2206, ÜK.2207, ÜK.2208



Düz/Straight
35 cm **ÜK.2215**
50 cm **ÜK.2216**

1/1

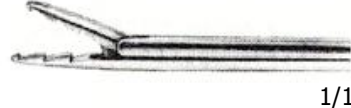

Düz/Straight
35 cm **ÜK.2217**
50 cm **ÜK.2218**

1/1



Düz/Straight
35 cm **ÜK.2219**
50 cm **ÜK.2220**

1/1

Ø 6 mm



Oval, Düz/Oval, Straight
35 cm **ÜK.2221**
50 cm **ÜK.2222**

1/1

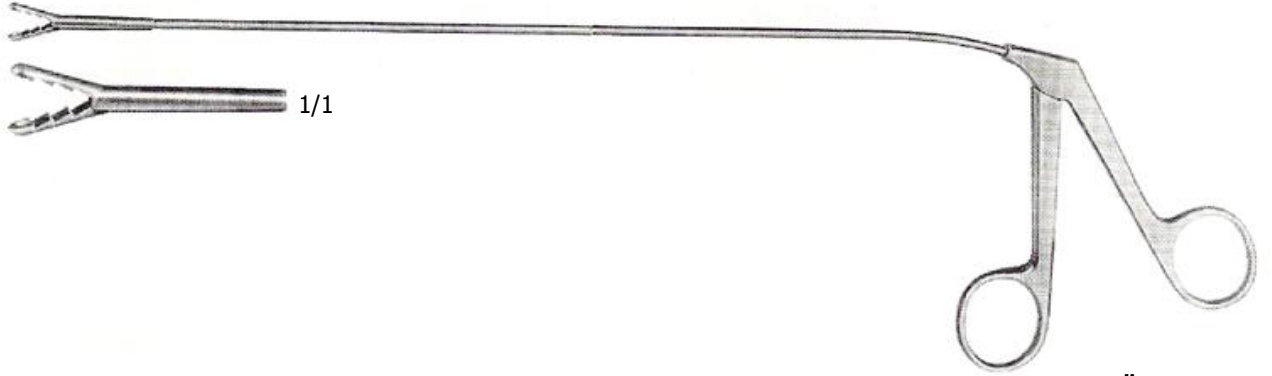

1/1

35 cm **ÜK.2223**
50 cm **ÜK.2224**

Ø 3.5 mm

Ø 2.0 mm



Olive Ø 9 mm

LUER Bağlantılı
With LUER Hub
35 cm **ÜK.2225**
50 cm **ÜK.2226**

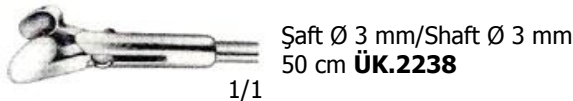
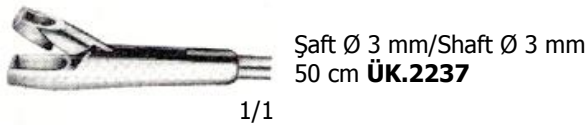
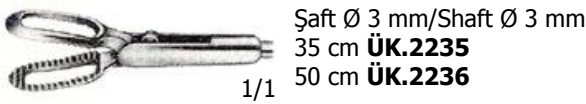
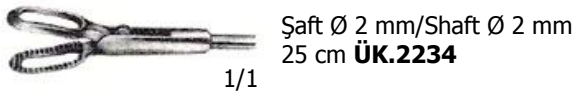
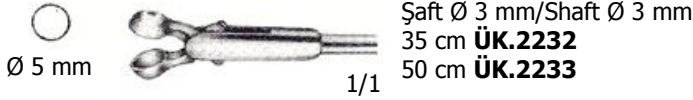
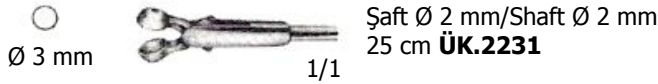
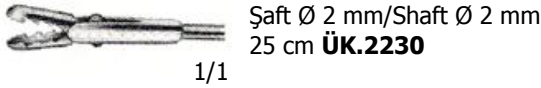
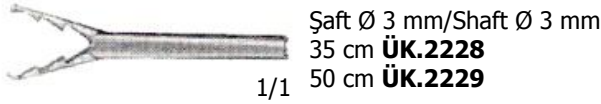
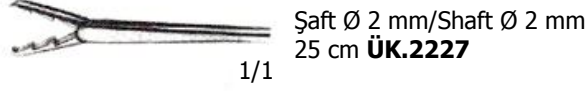
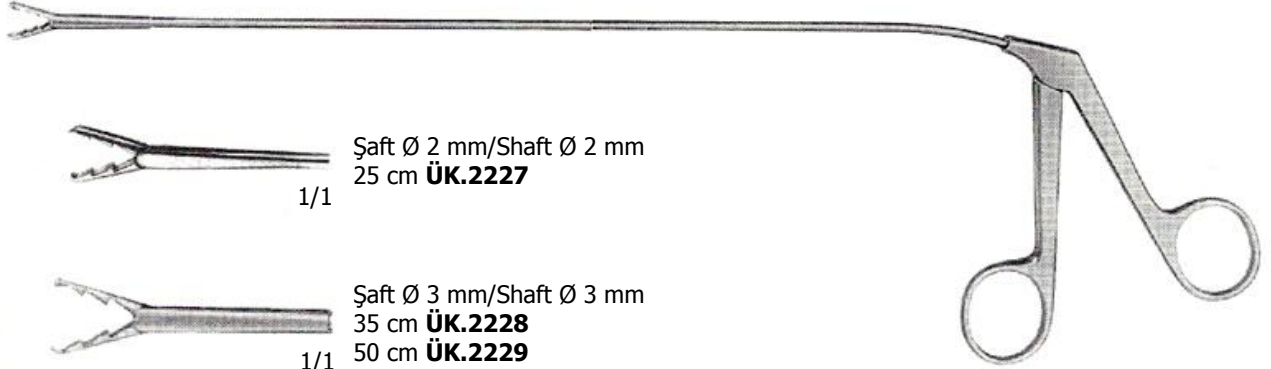

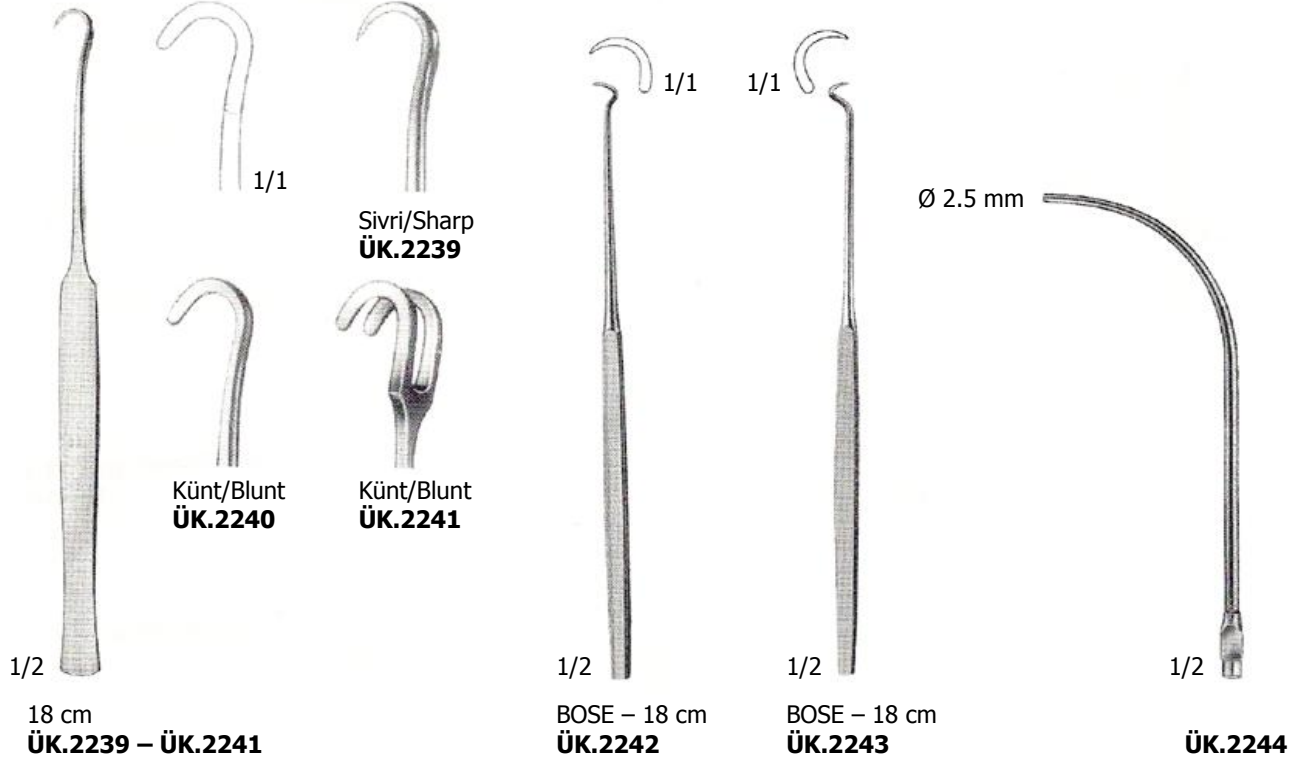



BOSE - 6 cm
ÜK.2248



5 cm
ÜK.2249



5.5 cm
ÜK.2250



4.5 cm
ÜK.2251

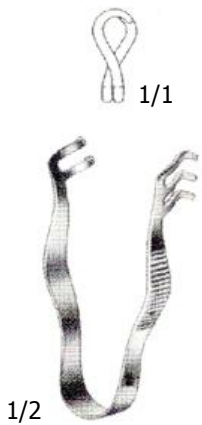

FINSEN – 7.5 cm
ÜK.2252

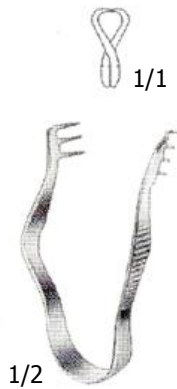

FINSEN - 7 cm
ÜK.2253



FINSEN - 7 cm
ÜK.2254



6. BÖLÜM

AĞIZ, YÜZ CERRAHİSİ Oral, Facial Surgery

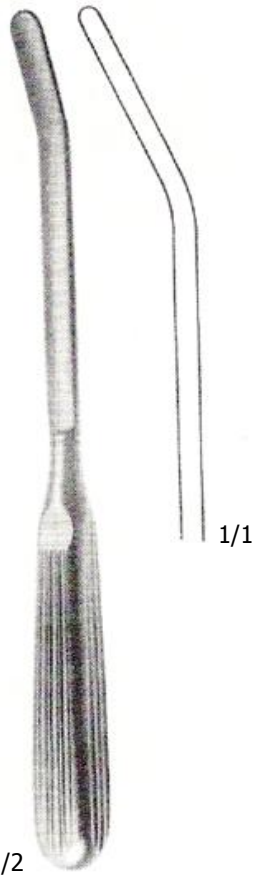

1/2
GILLIES - 21 cm
ÜK.2255



1/2
OBWEGESER - 23.5 cm
ÜK.2256



1/2
DINGMANN - 21 cm
ÜK.2257



1/2
OBWEGESER - 18.5 cm
ÜK.2258



1/2
OBWEGESER - 18.5 cm
ÜK.2259

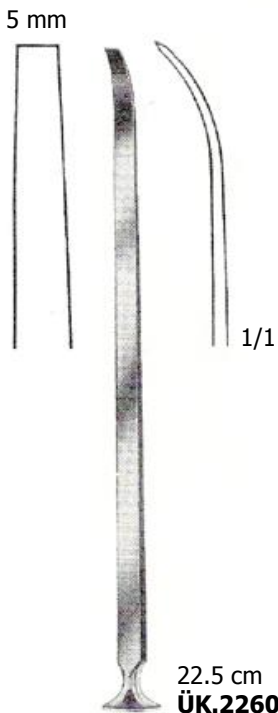

22.5 cm
ÜK.2260

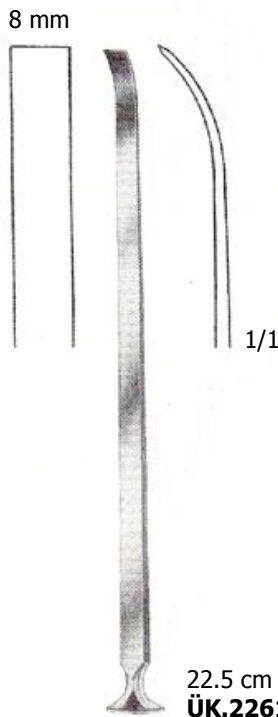

22.5 cm
ÜK.2261

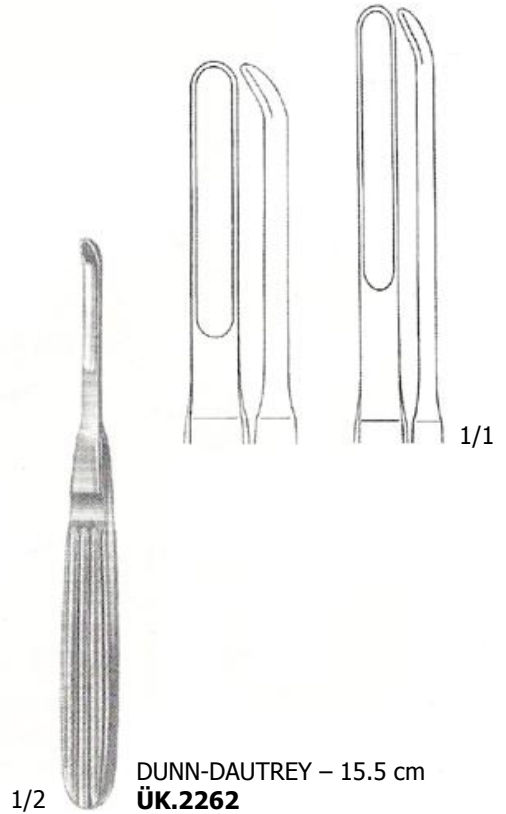

1/2
DUNN-DAUTREY - 15.5 cm
ÜK.2262

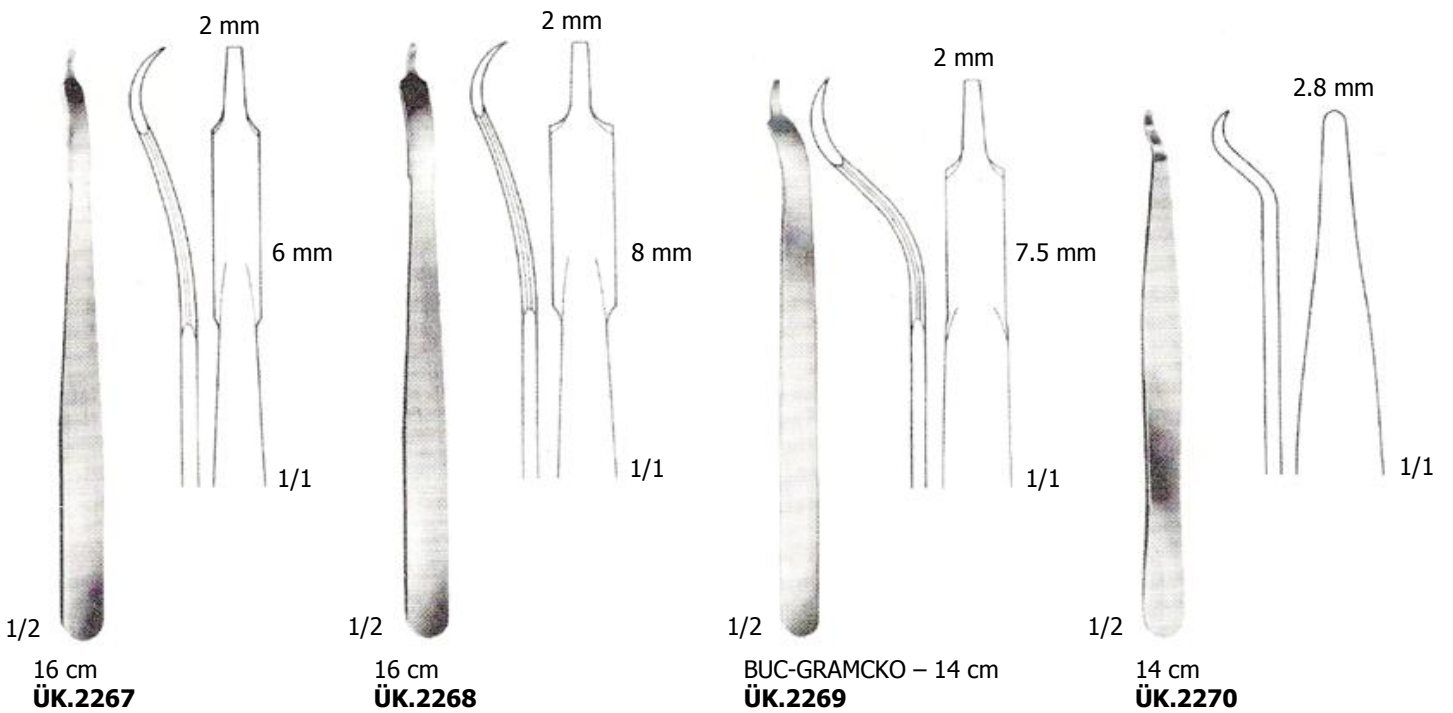
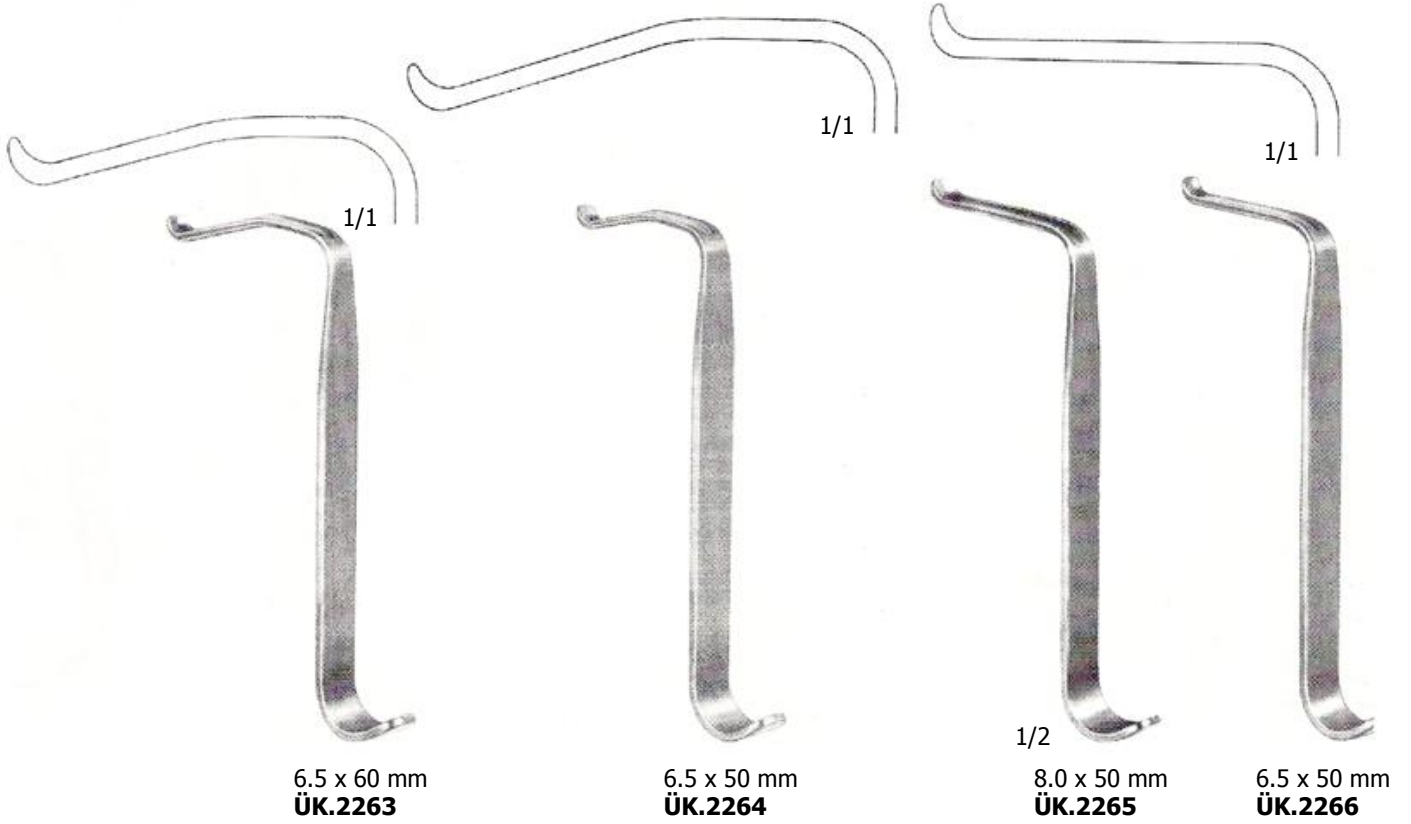

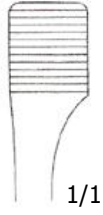

TESSIER
Sol/Left
ÜK.2271

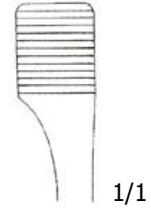

TESSIER
Sağ/Right
ÜK.2272



COTTLE
ÜK.2273 – ÜK.2276

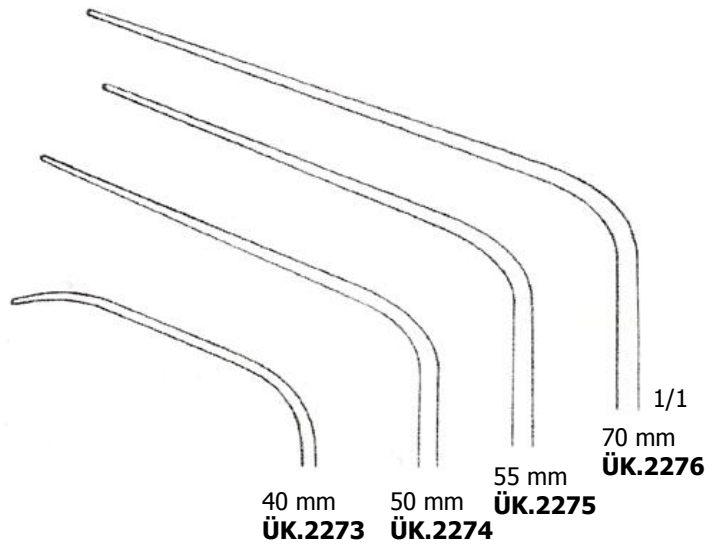

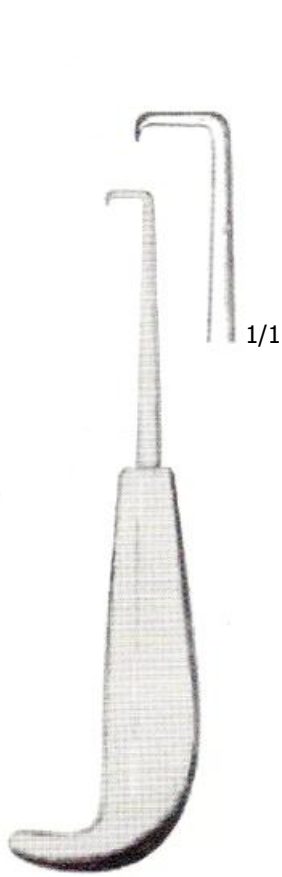

DINGMAN
17.5 cm
ÜK.2277

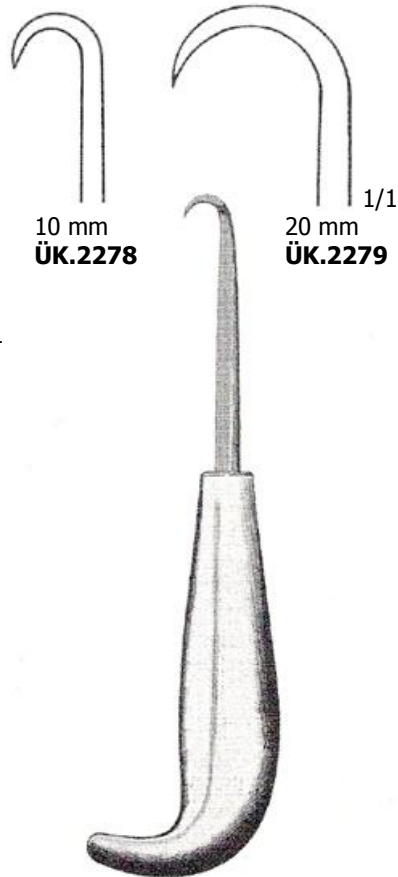

10 mm
ÜK.2278

20 mm
ÜK.2279

19 cm
ÜK.2278 – ÜK.2279



SORENSEN-HEIN
17.5 cm
ÜK.2280



1/2
DUNN-DAUTREY
13.5 cm
ÜK.2281

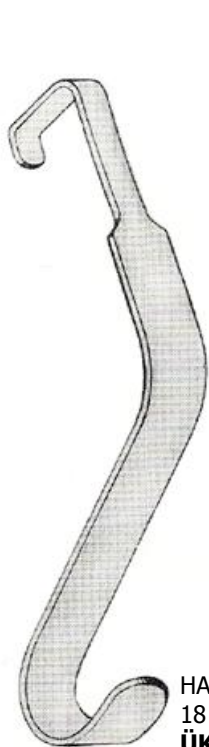

HAJEK
18 cm
ÜK.2282

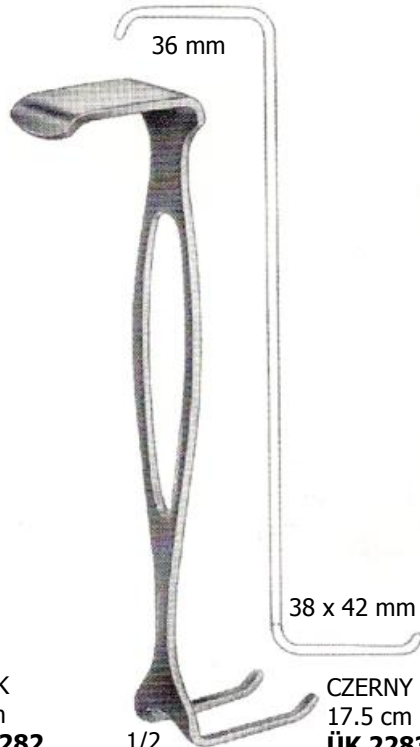

36 mm
38 x 42 mm
1/2
CZERNY
17.5 cm
ÜK.2283



OBWEGESER
16 cm
8 mm ÜK.2284
10 mm ÜK.2285

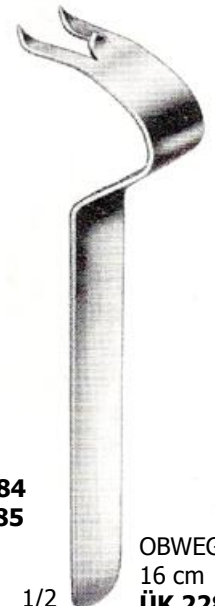

1/2
OBWEGESER
16 cm
ÜK.2286



1/2

24 cm
ÜK.2287

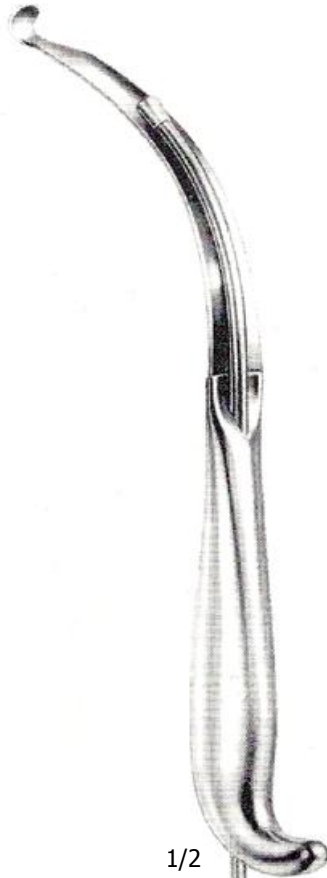

1/2

27 cm
ÜK.2288
Işık Taşıyıcı
With Light Carrier

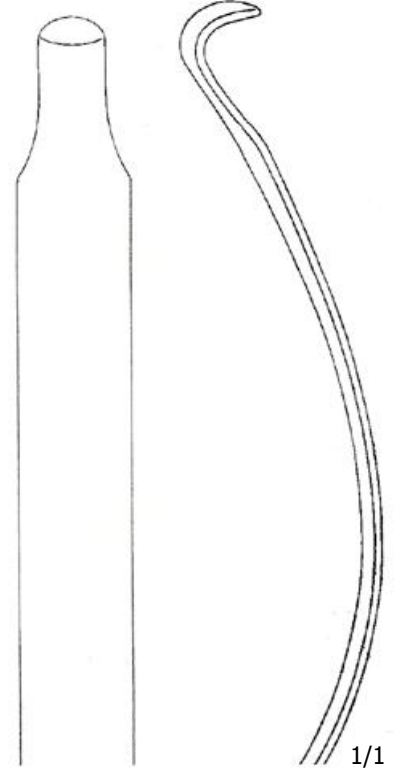

1/1

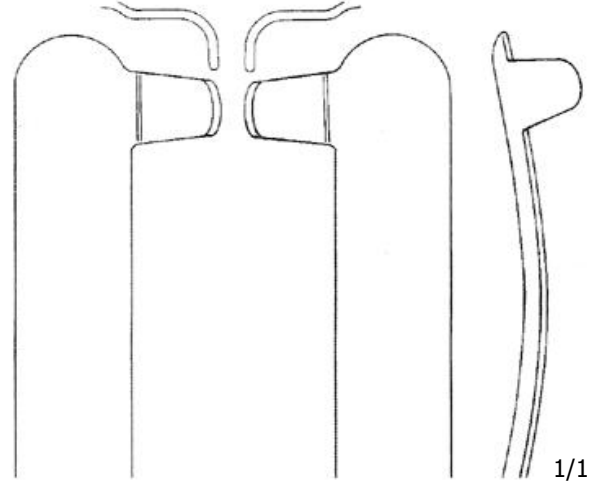

21 cm
ÜK.2289



21 cm
ÜK.2290



24 cm
ÜK.2291
Işık Taşıyıcı
With Light Carrier

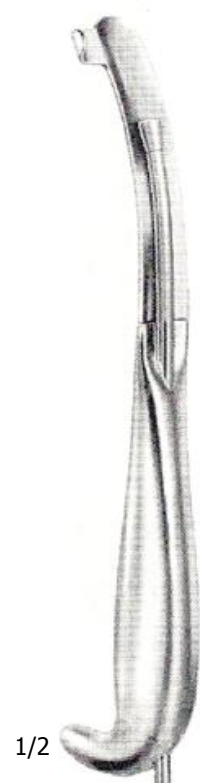

24 cm
ÜK.2292
Işık Taşıyıcı
With Light Carrier

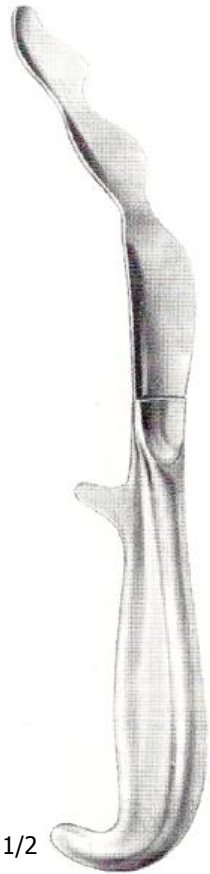

1/2

24 cm
ÜK.2293

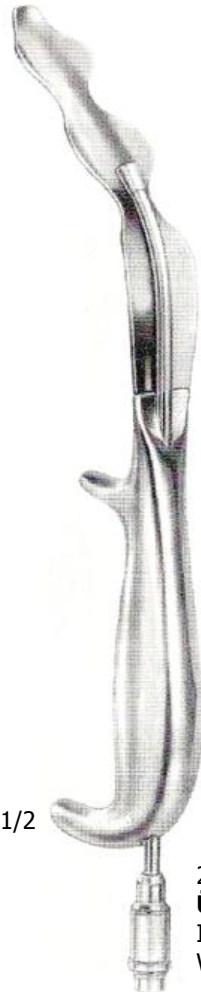

1/2

27 cm
ÜK.2294
Işık Taşıyıcı
With Light Carrier

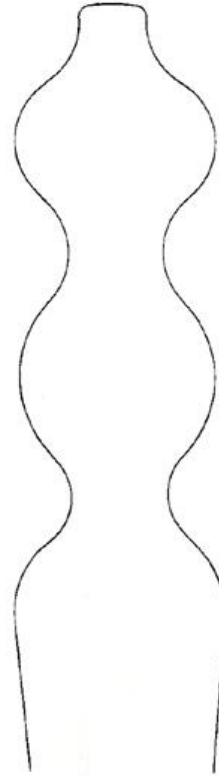

1/1

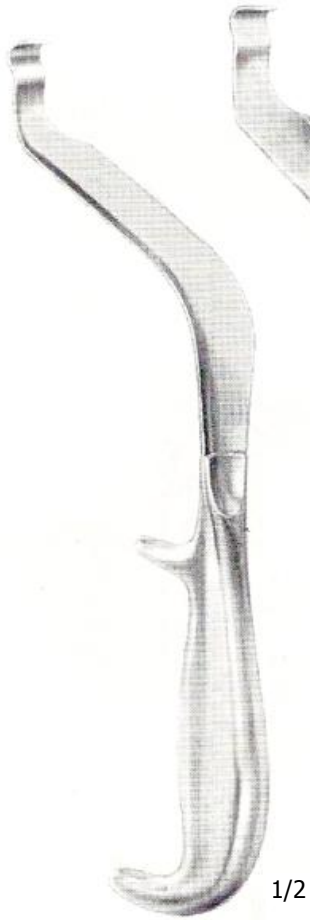

25 cm
ÜK.2295



28 cm
ÜK.2296
Işık Taşıyıcı
With Light Carrier

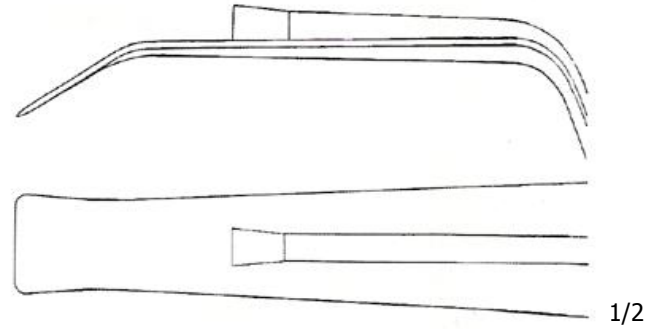

24 cm
ÜK.2297
Işık Taşıyıcı
With Light Carrier

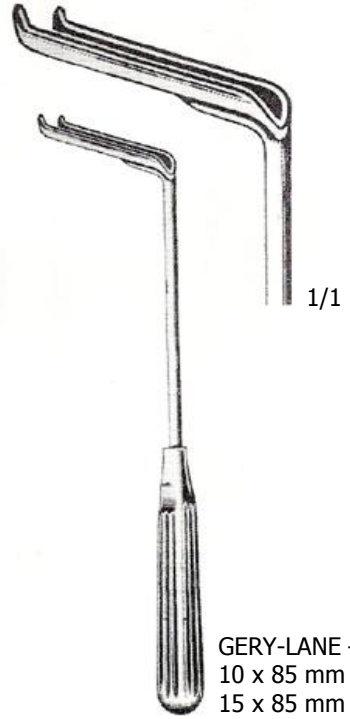

STEINHAUSER
Komple/Complete
23.5 cm **ÜK.2303**



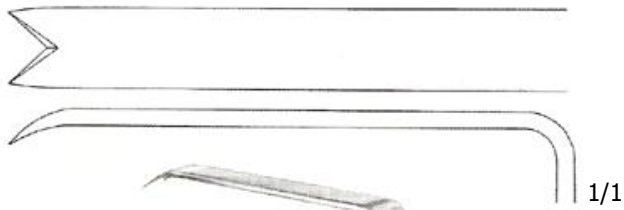

1/2

OBWEGESER – 22 cm
10 x 42 mm **ÜK.2306**



1/2

OBWEGESER – 22 cm
11 x 70 mm **ÜK.2307**



1/2

OBWEGESER – 21.5 cm
ÜK.2308 – ÜK.2313

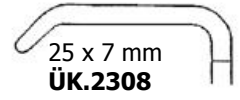

25 x 7 mm
ÜK.2308



31 x 10 mm
ÜK.2309



42 x 11 mm
ÜK.2310

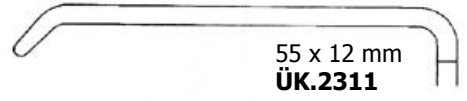

55 x 12 mm
ÜK.2311



70 x 14 mm
ÜK.2312



80 x 16 mm
ÜK.2313

1/1



1/2

OBWEGESER – 21.5 cm
ÜK.2314 – ÜK.2319



80 x 16 mm
ÜK.2314

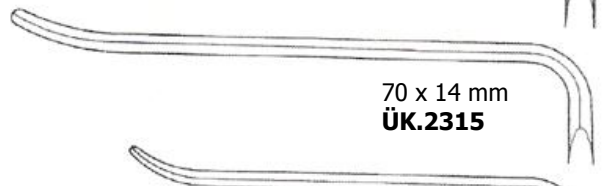

70 x 14 mm
ÜK.2315



55 x 12 mm
ÜK.2316



42 x 11 mm
ÜK.2317



31 x 10 mm
ÜK.2318

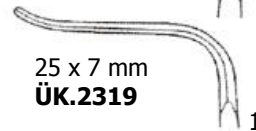

25 x 7 mm
ÜK.2319

1/1

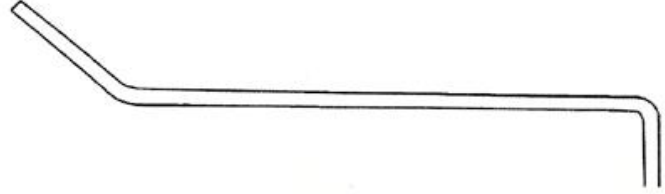

20 mm
ÜK.2320

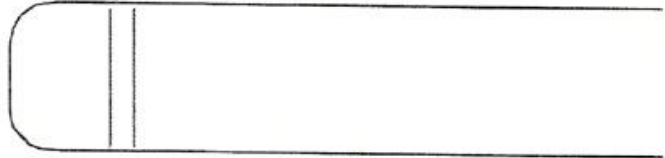

25 mm
ÜK.2321

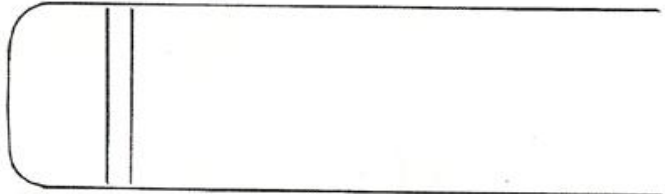

30 mm
ÜK.2322

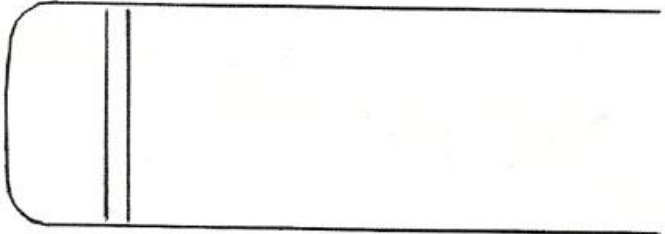

35 mm
ÜK.2323 1/1

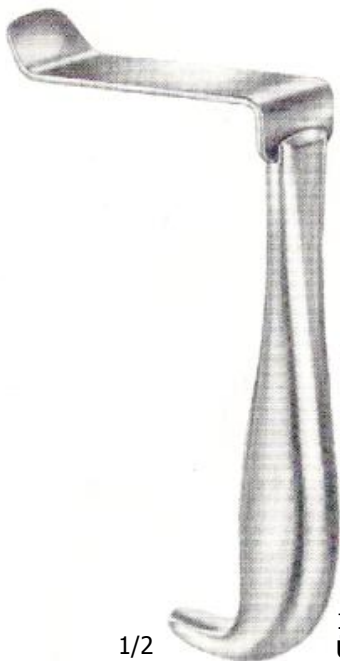

1/2

16 cm
ÜK.2320 – ÜK.2323

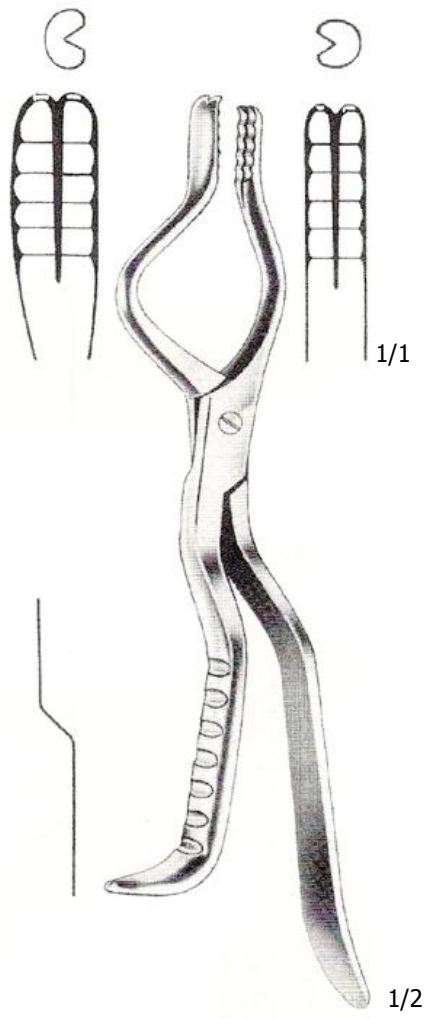

POWE-DINGMAN – 25 cm
Sağ/Right **ÜK.2324**

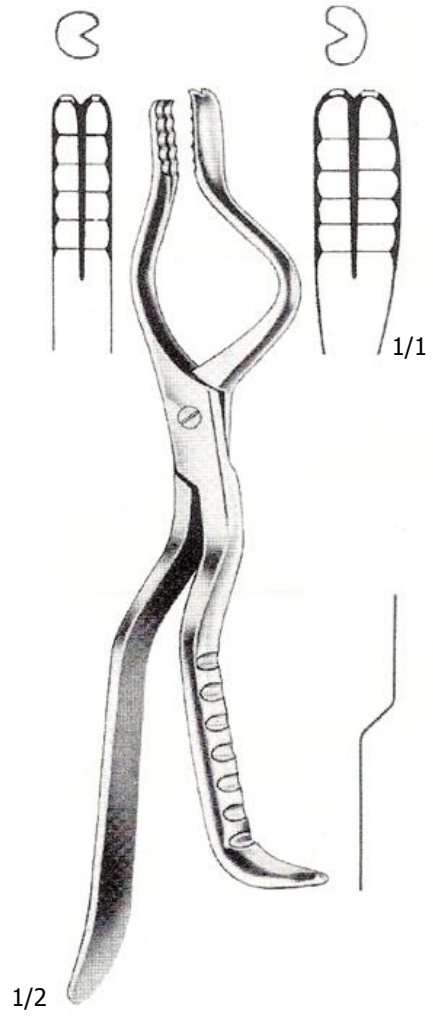

POWE-DINGMAN – 25 cm
Sol/Left **ÜK.2325**

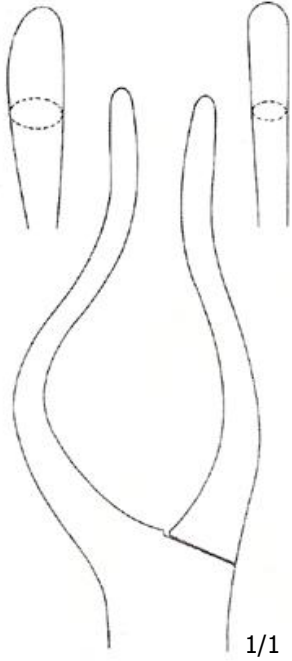

22.5 cm
Sol/Left **ÜK.2326**
Sağ/Right **ÜK.2329**
Bebekler ve Küçük Çocuklar İçin
For Babies and Infants

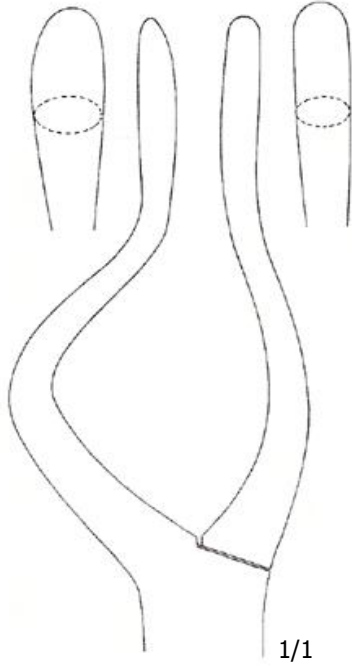

23.5 cm
Sol/Left **ÜK.2327**
Sağ/Right **ÜK.2330**
Çocuklar ve Gençler İçin
For Children and Adolescents

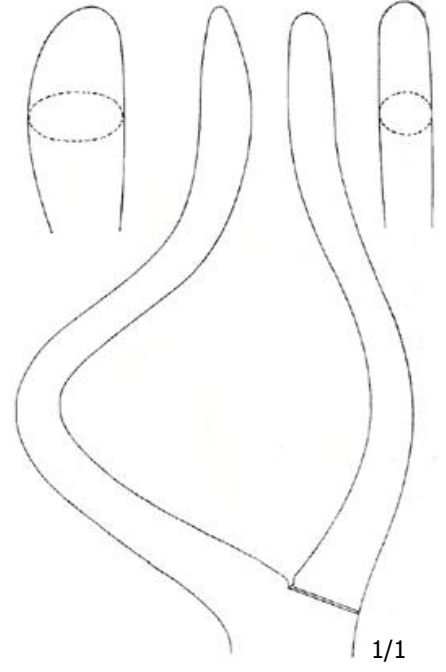

24 cm
Sol/Left **ÜK.2328**
Sağ/Right **ÜK.2331**
Yetişkinler İçin
For Adults

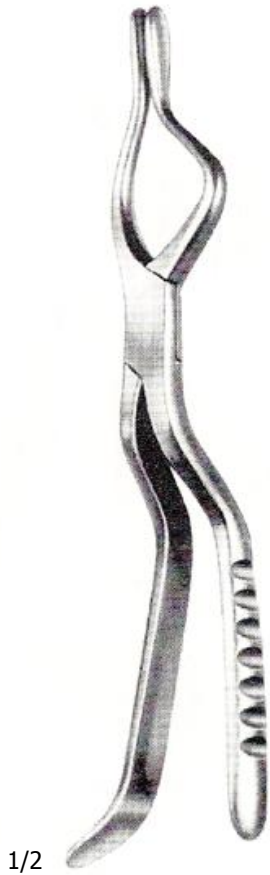

POWE
Sol/Left
ÜK.2326 – ÜK.2328

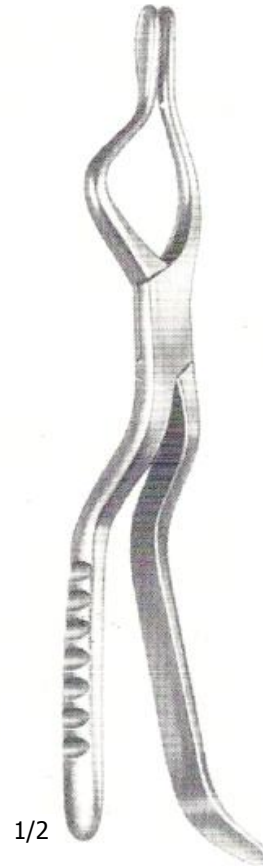

POWE
Sağ/Right
ÜK.2329 – ÜK.2331

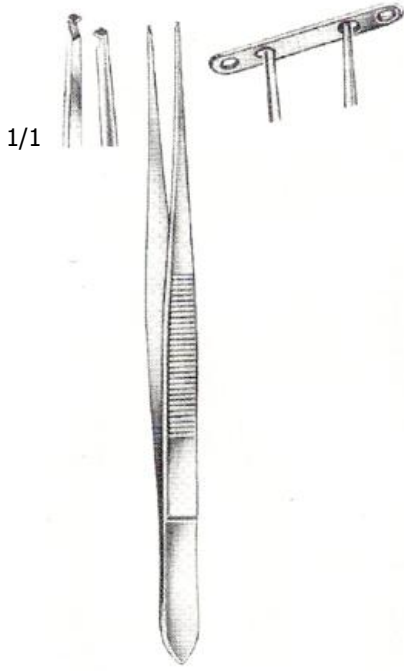

14 cm
ÜK.2332

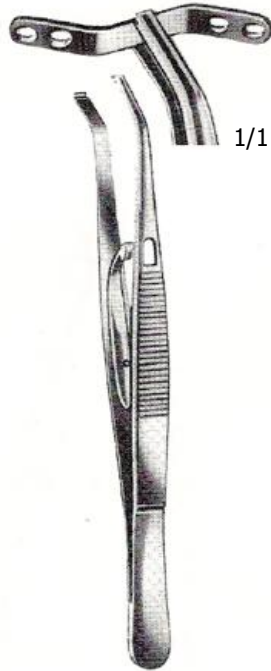

14 cm
ÜK.2333

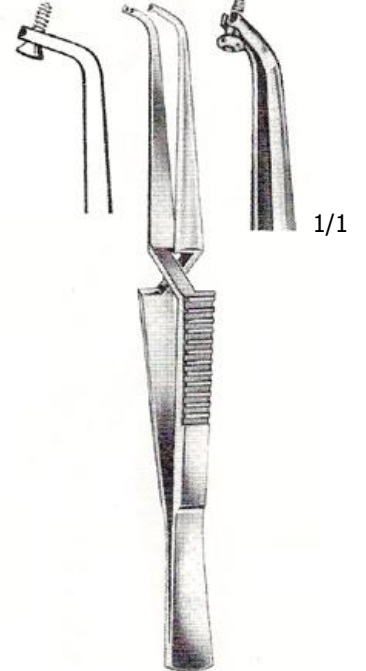

15 cm
ÜK.2334

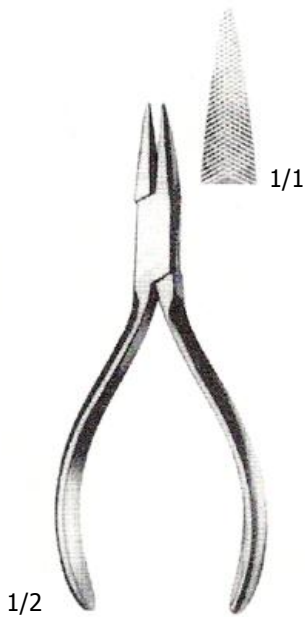

1/2
14 cm ÜK.2335
Çift Ağız Tırtıllı
Both Jaws Serrated

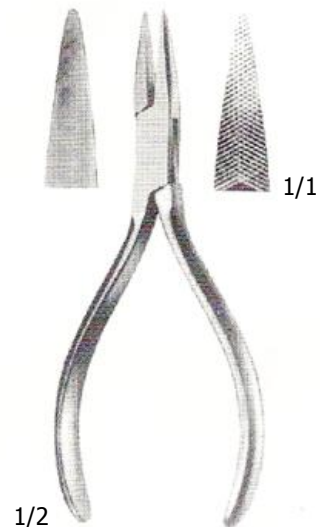

1/2
14 cm ÜK.2336
Tek Ağız Tırtıllı
One Jaw Serrated



LINDEMANN – 8 cm
ÜK.2337



Ø 2.7 mm
STEINHAUSER – 12 cm
ÜK.2338



LINDEMANN – 6.5 cm
ÜK.2339



LINDEMANN – 4.5 cm
ÜK.2340



23 cm
Klavuz/Guide
ÜK.2343



2.5 mm
ÜK.2341



Pin
ÜK.2342



20 cm
ÜK.2344

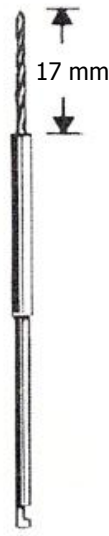

Ø 1.5 mm
ÜK.2345



Ø 1.5 mm
ÜK.2346



ÜK.2347
ÜK.2341 ve ÜK.2342
İle Kullanılır
To Be Use With
ÜK.2341 and ÜK.2342